

Diagnostic Thermal Imager



User Manual

Legal Information

Patent Pending

Trademarks

Snap-on is a trademark registered in the United States and other countries of Snap-on Incorporated. All other marks are trademarks or registered trademarks of their respective holders.

Copyright Information

© 2016 Snap-on Incorporated. All rights reserved.

Disclaimer of Warranties and Limitation of Liabilities

All pictures and illustrations shown are for reference purposes only. All information, specifications and illustrations in this manual are based on the latest information available at the time of printing and are subject to change without notice. While the authors have taken due care in the preparation of this manual, nothing contained herein:

- Modifies or alters in any way the standard terms and conditions of the purchase, lease, or rental agreement under the terms of which the equipment to which this manual relates was acquired.
- Increases in any way the liability to the customer or to third parties.





Snap-on[®] reserves the right to make changes at any time without notice.

IMPORTANT:

Before operating or maintaining this unit, please read this manual carefully paying extra attention to the safety warnings and precautions.

Product Compliance and Certification

This product is certified and/or in compliance with the guidelines and regulations set forth by the following:

United States and Canada		Europe	Australia
(California Only) California Energy Commission (CEC)	(U.S. and Canada) Underwriters Laboratories (UL)	Conformité Européene (European Conformity)	Regulatory Compliance Mark (RCM)
			

User Manual

A copy of the user manual is located on the Thermal Imager microSD card. See Connect to PC (Transfer Images / View User Manual) on page 13 for additional information.

The information in this manual is periodically revised to ensure the latest information is included. Download the latest version of this manual, and other related documentation from your applicable Snap-on Diagnostics website (see website information in *Customer Support Information* on the next page).

Customer Support Information

North America	
Website	http://diagnostics.snapon.com
Phone	1-800-424-7226
E-mail	diagnostics_support@snapon.com
Online Contact Form	https://www1.snapon.com/diagnostics/us/Contact

United Kingdom	
Website	https://www1.snapon.com/diagnostics/UK/Diagnostics.htm
Phone	+44 (0) 845 601 4736
E-mail	diagnosticsUKproductsupport@snapon.com

Australia and New Zealand	
Website	http://www.snapontools.com.au
Phone	(Australia) 1-800-810-581
	(New Zealand) 800-441-762
E-mail	sota.diagnostics@snapon.com

For technical assistance in all other markets, contact your selling agent.

Contents

Conventions.....	1
General Features.....	3
Controls and Connections	4
Technical Specifications	5
Getting Started	6
About - Temperature Readings.....	7
About - Automatic Calibration	8
Toolbar Icons and Menu Navigation.....	8
Imager Operation.....	10
Saving Images	10
Viewing and Deleting Images	10
Connect to PC (Transfer Images / View User Manual).....	13
Expert Tips	14
Demonstration.....	17
Settings.....	18
Color Palette	20
Brightness	20
Temperature	21
Power	21
Emissivity	22
Date and Time	23
Navigation Tips	23
About (Factory Reset).....	24
Examples.....	26
Cabin HVAC Leaks	26
Exhaust Manifold Temperature Balance	27
Differential Bearing	27
Heated Seat Operation	28
Window Defog/Defrost Operation	28
Wheel Bearing (Hub Assy.).....	29
Storage	30
Cleaning	30
Battery Pack	31
Safety Guidelines	31
Charging	32
Remove/Install	34
Ordering a Replacement Battery	36
Disposal	37
Troubleshooting Chart.....	38

Safety Information

READ ALL INSTRUCTIONS

For your own safety, the safety of others, and to prevent damage to the product and vehicles upon which it is used, it is important that all instructions and safety messages in this manual and in the *Important Safety Instructions* (included with the Thermal Imager) be read and understood by all persons operating, or coming into contact with the product, before operating. We suggest you store a copy of each, near the product in sight of the operator.

For your safety, read all instructions. Use your diagnostic tools only as described in the tool user's manual. Use only manufacturer recommended parts and accessories with your diagnostic tools.

This product is intended for use by properly trained and skilled professional automotive technicians. The safety messages presented throughout this manual and in the supplied *Important Safety Instructions* are reminders to the operator to exercise extreme care when using this product.

There are many variations in procedures, techniques, tools, and parts for servicing vehicles, as well as in the skill of the individual doing the work. Because of the vast number of test applications and variations in the products that can be tested with this instrument, we cannot possibly anticipate or provide advice or safety messages to cover every situation. It is the responsibility of the automotive technician to be knowledgeable of the system being tested. It is essential to use proper service methods and test procedures. It is important to perform tests in an appropriate and acceptable manner that does not endanger your safety, the safety of others in the work area, the equipment being used, or the vehicle being tested.

It is assumed that the operator has a thorough understanding of vehicle systems before using this product. Understanding of these system principles and operating theories is necessary for competent, safe and accurate use of this instrument.

Before using the equipment, always refer to and follow the safety messages and applicable test procedures provided by the manufacturer of the vehicle or equipment being tested. Use the product only as described in its user manual. Use only manufacturer recommended parts and accessories with your product.

Read, understand and follow all safety messages and instructions in this manual, the supplied *Important Safety Instructions*, and on the test equipment.

Environmental Conditions:

- This product is intended for indoor use only
- This product is rated for Pollution Degree 2 (normal conditions)

Safety Signal Words

All safety messages contain a safety signal word that indicates the level of the hazard. An icon, when present, gives a graphical description of the hazard. Safety Signal words are:

DANGER

Indicates an imminently hazardous situation which, if not avoided, will result in death or serious injury to the operator or to bystanders.

WARNING

Indicates a potentially hazardous situation which, if not avoided, could result in death or serious injury to the operator or to bystanders.

CAUTION

Indicates a potentially hazardous situation which, if not avoided, may result in moderate or minor injury to the operator or to bystanders.

Safety Message Conventions

Safety messages are provided to help prevent personal injury and equipment damage. Safety messages communicate the hazard, hazard avoidance and possible consequences using three different type styles:

- Normal type states the hazard.
- **Bold type states how to avoid the hazard.**
- *Italic type states the possible consequences of not avoiding the hazard.*

An icon, when present, gives a graphical description of the potential hazard.

Safety Message Example

WARNING



Risk of unexpected vehicle movement.

- **Block drive wheels before performing a test with engine running.**

A moving vehicle can cause injury.

Important Safety Instructions

For a complete list of safety messages, refer to the accompanying *Important Safety Instructions manual*.

SAVE THESE INSTRUCTIONS

This manual contains basic operating instructions and is structured in a manner to help you become familiar with the tool features and perform basic operations.

The illustrations in this manual are intended as reference only and may not depict actual screen results, information, functions or standard equipment.

The following information is intended as reference, using general content to describe the use of conventions in this manual. Not all examples, conventions or content may be used, or applicable within this manual.

1.1 Conventions

1.1.1 Bold Text

Bold emphasis is used in procedures to highlight selectable items such as buttons and menu options.

Example:

- Select **Functions**.

1.1.2 Symbols

The “greater than” arrow (>) indicates an abbreviated set of selection instructions.

Example:

- Select **Utilities > Tool Setup > Date**.

The above statement abbreviates the following procedure:

1. Select the **Utilities** icon.
2. Select the **Tool Setup** submenu.
3. Highlight the **Date** option from the submenu.

1.1.3 Terminology

The term “select” describes tapping/touching an icon on the touch screen, or highlighting an icon or menu choice and then selecting the confirmation menu choice such as **Continue, Accept, OK, Yes**, or other similar choice.

Example:

- Select **Reset**.

The above statement abbreviates the following procedure:

1. Navigate to the **Reset** icon.
2. Select the **Reset** icon with your stylus.

1.1.4 Notes and Important Messages

The following messages are used.

Note

A note provides helpful information such as additional explanations, tips, and comments.

Example:

**NOTE:**

For additional information refer to...

Important

Important indicates a situation which, if not avoided, may result in damage to the test equipment or vehicle.

Example:

IMPORTANT:

Do not use any abrasive cleansers or automotive chemicals on the tool.

1.1.5 Procedures

An arrow icon indicates a procedure.

Example:

**To change screen views:**

1. Select **View**.
The dropdown menu displays.
2. Select an option from the menu.
The screen layout changes to the format you selected.

1.1.6 Hyperlinks

Hyperlinks, or links, that take you to other related articles, procedures, and illustrations are available in electronic documents. Blue colored text indicates a selectable hyperlink.

Example:

IMPORTANT:

Read all applicable [Safety Information](#) before using this tool!

This chapter introduces the basic features of the Diagnostic Thermal Imager.

The Thermal Imager is a specialized device used to make non-contact thermal measurements, and visually reveal heat sources to help locate and identify vehicle faults (e.g. friction, electrical impedance, engine misfires, fluid blockage, HVAC leaks and more).







2.1 General Features



Figure 2-1

2.2 Controls and Connections



Item	Name	Description	
1	Battery Charging LED Indicator	The battery charging LED indicator, illuminates when the battery is being charged.	
2	micro USB Jack	The micro USB jack provides connection (via supplied USB cable) for the power supply adapter (battery charging), and to a personal computer for saved image transfer.	
3	microSD (Secure Digital) Card	The microSD card stores saved images, expert tips content, and a copy of this user manual. During operation the microSD card must be installed to save and view images, and view expert tips.	
4	Screen Capture Trigger	Press to capture an image of the active display.	
5	Cancel (No) Button		Press to close a menu, and or return to the previous menu or screen.
6	Accept (Yes) Button		Press to confirm, or select a menu option.
7	Menu Button		Press to open the expert tips menu, or return to imager mode.
8	Left / Right Directional Control Buttons		Press to navigate left/right toolbar, and menu options.
9	Up / Down Directional Control Buttons		Press to navigate up/down toolbar, and menu options.
10	Power Button		Press to turn the Thermal Imager on/off.

2.3 Technical Specifications

Item	Description / Specification
Display	Size (diagonal) - 89 mm (3.5 in.)
	Resolution - 320 x 240
Color Palettes	4 options: Iron, Rainbow, Grey, Cool-Hot
Measurement Range	-20 to 450 °C (-4 to 840 °F)
Image Storage Memory Capacity	4000 images
Image File Format	.bmp
Thermal Sensitivity (NETD)	< 50mK (millidegrees Kelvin)
IR Image Refresh Rate	9 times per second
Radiometric Accuracy	+/- 7 degrees Celsius (12.6 degrees Fahrenheit) or 5%, whichever is greater (Typical, after a minimum warm-up of 5 minutes)
Spectral Range	Longwave infrared, 8 to 14 µm
USB Interface	2.0 USB, micro USB
Battery	Rechargeable Lithium Ion Battery Pack +3.6 VDC at 2000mAh (nominal)
	Approximate 4 hour continuous operation, with the brightness level setting at 50%
	Approximate 80% charge in 3-hours, 100% charge in less than 5-hours
USB Power Supply Adapter	Supply Rating: 5 VDC, 2A
DC Operating Voltage (USB input)	4.75 to 5.25 VDC
Operating Altitude	Maximum 2000 m
Width	3.81 in. (96.8 mm)
Height	8.5 in. (215.9 mm)
Depth	2.0 in. (50.8 mm)
Weight	0.75 lb (340.2 g)
Operating Temperature Range (ambient)	At 0 to 90% relative humidity (non-condensing) 32 to 113°F (0 to 45°C)
Storage Temperature (ambient)	At 0 to 70% relative humidity (non-condensing) -4 to 140°F (-20 to 60°C)
Environmental Conditions	This product is intended for indoor use only. It is not rated for damp or wet locations.
	This product is rated for Pollution Degree 2 (normal conditions)

This chapter describes the menu navigation and operation of the Diagnostic Thermal Imager.

3.1 Getting Started



Diagnostic Thermal Imager Operation:

1. If necessary, fully charge the battery pack, see [Charging](#) on page 32.



NOTE:

The Thermal Imager is powered by an internal rechargeable Lithium Ion battery pack. A fully charged battery pack can provide up to 4 hours of continuous operation (brightness level setting at 50%).

2. Press and hold the **Power** button until the introductory screen displays, then release. When the Power button is pressed, an audible tone (beep) will be sounded. After the introductory screen fades, the Thermal Imager opens into imager mode ([Figure 3-1](#)). From imager mode, you are able to take temperature measurements, save images, and check battery charge status. To turn off, press and hold the **Power** button until the Thermal Imager turns off.

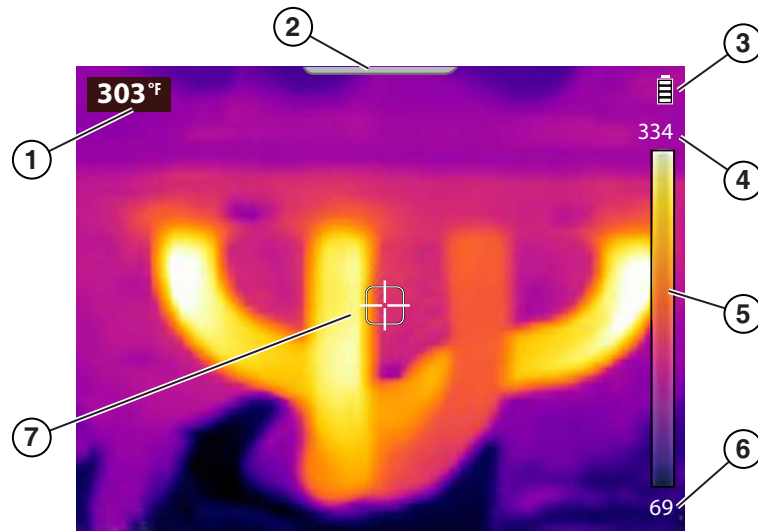

1. **Center Region Temperature (Average)**
2. **Menu Screen Tab**
3. **Battery Level Icon**
4. **Color Pallet - Upper Temperature Range Limit**
5. **Color Pallet Range Indicator**
6. **Color Pallet - Lower Temperature Range Limit**
7. **Target (Center Region Temperature (Average))**

Figure 3-1 Imager Mode Features

The Thermal Imager is ready for use, however to ensure optimal measurement accuracy, it is recommended to allow the Thermal Imager to “warm-up” a minimum of 5 minutes before operation.



NOTE:

Onscreen Navigational Tips are provided for select menu navigation procedures. Each tip will appear only once after turning on the Thermal Imager. Navigational Tips can be enabled or disabled, see [Navigation Tips](#) on page 23.

3. If required, (depending on the object(s) being measured) set the color palette and emissivity settings as needed. See [Color Palette](#) on page 20 and [Emissivity](#) on page 22 for additional information. See [Settings](#) on page 18 for information on all device settings.
4. While in imager mode, point the Thermal Imager at the desired object(s) to be measured.
5. Use the target indicator in the center of the screen to locate and measure Center Region Temperature (Average) ([Figure 3-1](#)).
6. Press the **Screen Capture Trigger** to save an image of the active screen. See [Saving Images](#) on page 10 for additional information.

IMPORTANT:

A protective cover is used over the USB jack and microSD card slot, located on top of the Imager. Always keep the protective cover closed during operation. Only open the protective cover during battery charging, or when connecting to the PC, or removing the microSD card. Opening the protective cover during operation could result in an electrostatic discharge event that may cause the Thermal Imager to reset. If this occurs, the Thermal Imager will reset and return to normal operation without being damaged.

3.1.1 About - Temperature Readings

During imager mode, the thermal image is displayed using the color palette selected to define object temperatures. See [Color Palette](#) on page 20 for additional information. Use the color palette range indicator ([Figure 3-1](#)) to determine the temperature of objects within the thermal image.

Additional information:

- The Center Region Temperature (Average) is dynamically indicated within the color palette.
- The upper and lower temperature range limits will constantly change based on the active “scene” temperature.
- Symbols are used to indicate temperatures are out of scale range (see following table):

Example	Description
<p style="text-align: center;">>842°F (>450°C)</p> <p style="text-align: center;">or</p> <p style="text-align: center;">>356°F (>180°C)</p>	<p>The “>” symbol is used to indicate when the temperature being measured is above the range of the current scale.</p> <p>The “>” symbol is also used to indicate when the maximum measurable temperature has been reached for the current temperature range. There are two upper limit ranges (<i>see example</i>), and they are automatically selected based on a percentage of the scene temperature.</p>
<p style="text-align: center;"><-4°F (<-20°C)</p>	<p>The “<” symbol is used to indicate when the temperature being measured is below -4°F (-20C°).</p>

3.1.2 About - Automatic Calibration

The Thermal Imager uses an automatic calibration feature to ensure consistent and accurate temperature measurements are provided.

Additional Information:





- Calibration will occur during “warm-up”, and periodically during operation. A screen message (e.g. calibrating) is displayed during the process.
- An audible "click" may also be heard during calibration, and a temporary screen “freeze” occurs.
- A symbol is used to indicate calibration is about to occur (see following table):

Example	Description
	At one minute (or less) before a calibration occurs, a “~” symbol is displayed in front of the Center Region Temperature (Average) to indicate calibration is about to occur.

3.2 Toolbar Icons and Menu Navigation

Toolbar icons and general menu navigation is described in the following section.

There are four toolbar icons available (see following table):

Name	Icon	Description
Expert Tips		Select to open the expert tips menu. See Expert Tips on page 14.
Image Gallery		Select to open the image gallery. See Viewing and Deleting Images on page 10.
Delete (image)		Select to delete a saved image from the microSD card. Viewing and Deleting Images on page 10.
Settings		Select to open the device settings menu. Settings on page 18.



NOTES:

When the toolbar icons are selected, they will change color from red to white to indicate the function is active.

Menu options and icons that appear grayed out (transparent), indicate that they are not applicable.



To open and navigate the Menu screen:

1. Press the **Menu** button ([Figure 3-2](#)).



Figure 3-2

The menu screen slides open from the tab on the top of the screen (Figure 3-3). From the menu screen you can select options from the toolbar, or from the displayed menu.



NOTE:

The last menu viewed is displayed when the **Menu** button is pressed.

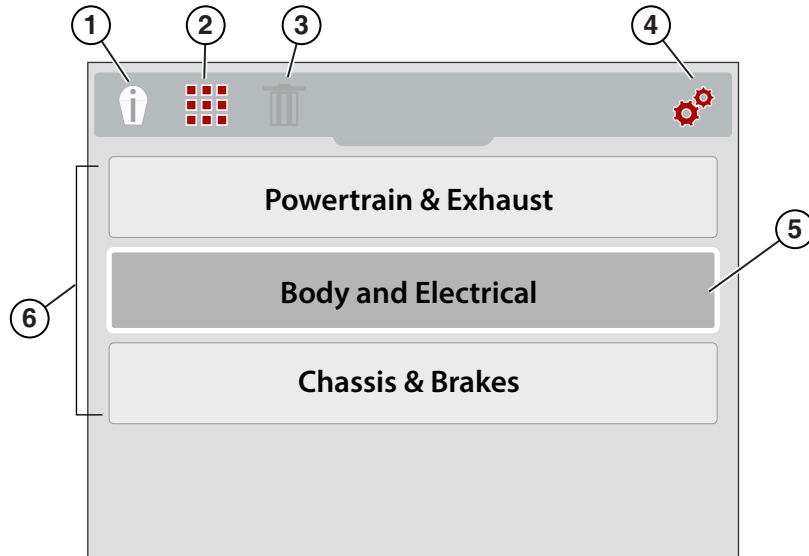

- 1. Expert Tips Icon - Opens the expert tips menu
- 2. Image Gallery Icon - Opens the gallery of saved images
- 3. Delete Icon - Use to delete saved images (shown grayed out)
- 4. Settings Icon - Opens the device settings menu
- 5. Selected Option - Indicated by white outer frame and darker interior color
- 6. Menu Options

Figure 3-3

- 2. To select an option from the toolbar, press the **Left** and **Right** (arrow) directional buttons (Figure 3-4).

An active selection is indicated by a white highlighted icon.

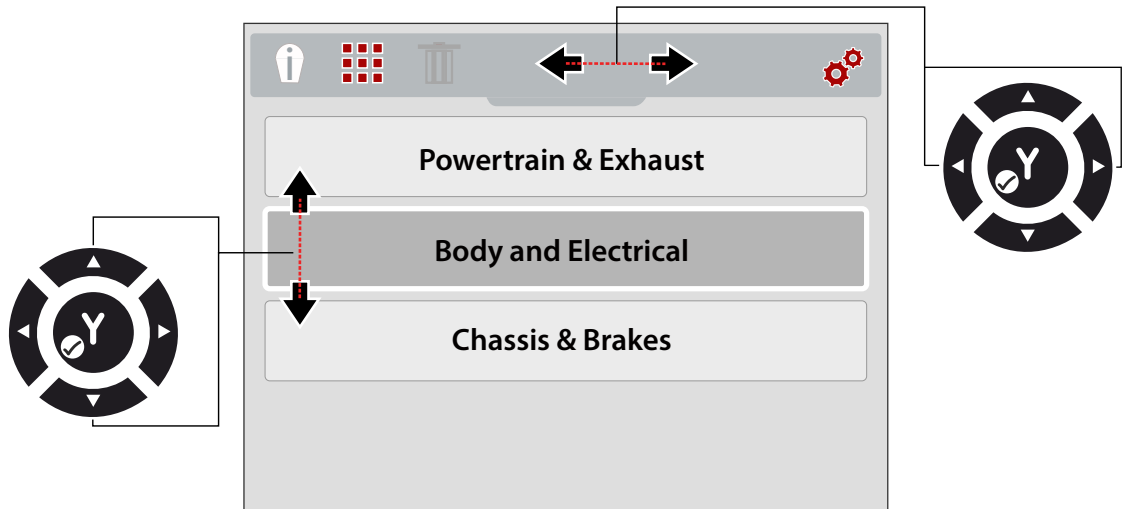

Figure 3-4

3. Press the **Y** button to select and open the option selected.
4. To select a menu option, press the **Up** and **Down** (arrow) directional buttons (Figure 3-4).
If more options are available than can be displayed onscreen, use the **Down** button to scroll down through the options.
5. When finished, press the **Menu** button to exit.

3.3 Imager Operation

3.3.1 Saving Images

You can save thermal images (screenshots) to the microSD memory card. Approximately 4000 images can be saved on the microSD card supplied from the factory. Images are saved using the (IMGxxxxx.BMP) file convention. In the convention "xxxxx" is a unique identifier.



NOTE:

When the Thermal Imager is connected by USB cable to a PC, saving and viewing images is disabled. If the screen capture trigger is pulled, or the gallery icon is selected while the USB cable is connected to a PC, an error message is displayed. To resume saving images, disconnect the USB cable from the PC.

**To save an image:**

When operating in imager mode, press and release the **Screen Capture Trigger** to save an image of the active screen.

When the trigger is activated:

- The screen will briefly change to still mode
- The Snap-on logo will be displayed momentarily
- An audible tone is sounded (2 beeps)

After the image is saved, you can continue operation as normal, and/or immediately save another image.

3.3.2 Viewing and Deleting Images

When you save an image, it is stored on the microSD card.

There are two methods to access the image Gallery. Both are described in this section.

- Press the **Left** directional button (Quick-Access), or
- Press the **Menu** button

**Using the Left directional button (Quick-Access) to access the gallery:**

1. During operation, (from imager mode) you can quickly access the image gallery by pressing the **Left** directional button.

The image file menu slides open from the top of the screen.

2. Proceed to [Using the Gallery \(viewing and deleting images\)](#) on page 11.

▶ Using the Menu button to access the gallery:

1. Press the **Menu** button (Figure 3-5).



Figure 3-5 Menu Button

The toolbar and menu slide open from the top of the screen.

2. If necessary, use the **Left** and **Right** directional buttons to select the **Gallery** icon from the toolbar (Figure 3-6).

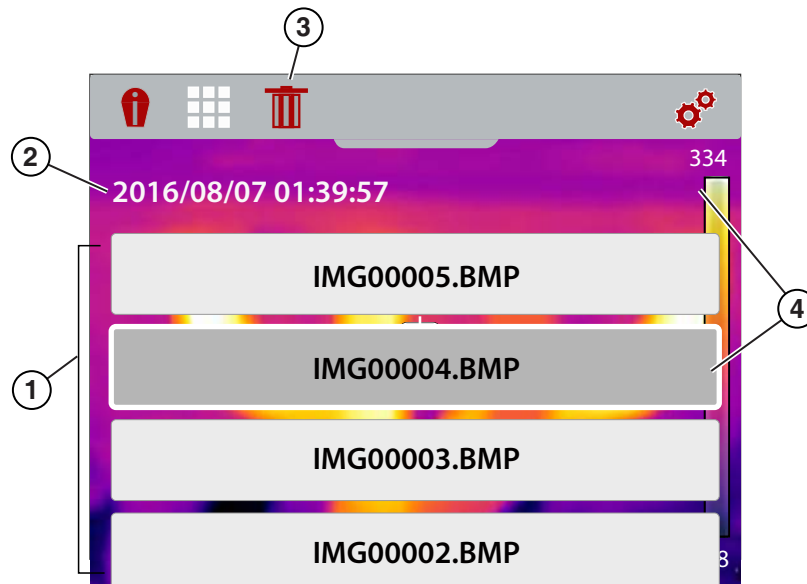

Figure 3-6 Image Gallery Icon

3. Press the **Y** button.
4. Proceed to [Using the Gallery \(viewing and deleting images\)](#).

▶ Using the Gallery (viewing and deleting images)

When the gallery opens, the image file menu is displayed with the most recently saved file on top (Figure 3-7).



1. Image File Menu
2. Image Date/Time
3. Delete Icon
4. Selected Image (displays in background)

Figure 3-7 Image Gallery Screen

Viewing an Image:

1. Use the **Up** and **Down** directional buttons to navigate through the image file menu (Figure 3-7).

An image is selected when a highlighted box appears around the selection. A selected image can be partially seen in the background, as you scroll through the image menu (Figure 3-7).

2. To view the saved image, select it from the menu, then press the **Y** button.
The image is displayed (Figure 3-8).

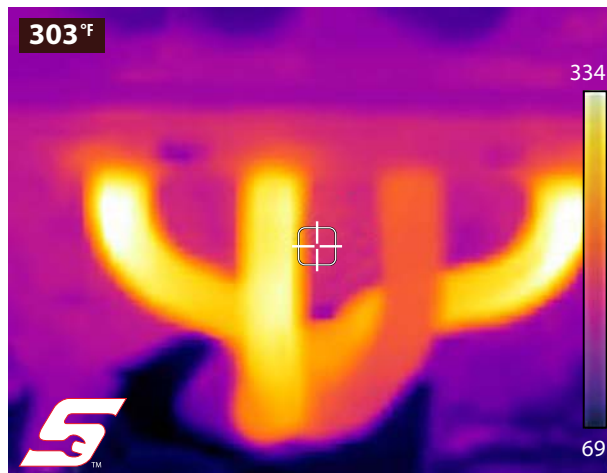

Figure 3-8 Saved Image - Example

3. To view all the other images, scroll using the **Up** and **Down** buttons.
4. Press the **N** button to return to the image file menu.



NOTE:

From the image file menu you can use the Left and Right directional buttons to make a menu selection from the toolbar (e.g Expert Tips, Gallery, Settings).

Deleting an Image

1. Select an image file from the image file menu, then use the Left and Right directional buttons to select the **Delete** (trash can icon) from the toolbar (Figure 3-9).



Figure 3-9 Delete Icon

2. Press the **Y** button to delete the image.

3.3.3 Connect to PC (Transfer Images / View User Manual)

The Thermal Imager can be connected to a PC using the supplied USB cable. This allows you to transfer saved images to the PC, and view the user manual (stored on the microSD card).



To connect to a PC and access the saved image files and the user manual:

1. Open the protective cover on top of the Thermal Imager, and connect the USB cable to the USB jack.
2. Turn the Thermal Imager on.
3. With your PC turned on, connect the USB cable to your PC.
4. The Thermal Imager will be recognized by your PC as an external storage device (e.g. DTI (E:), DTI (H:), etc.) (Figure 3-10).

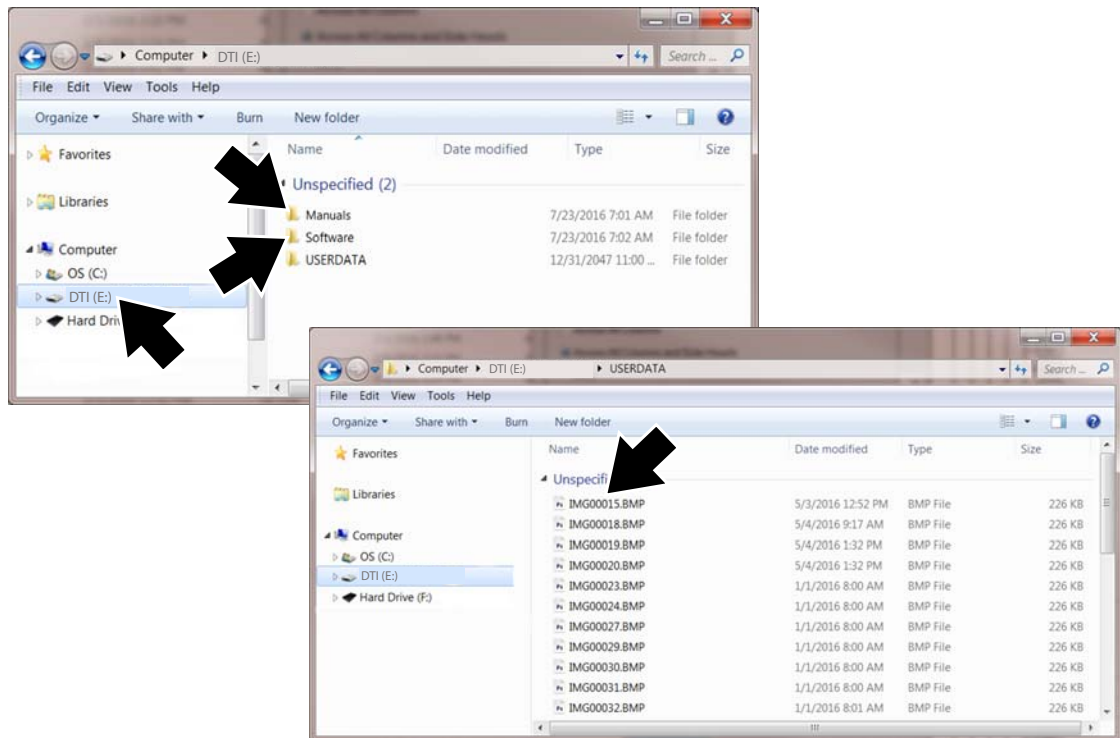

Figure 3-10 Typical PC screens

5. Using the standard Windows applications on your PC (e.g. Windows Explorer or Computer), select your saved images from the “**USERDATA**” folder, or select the user manual file from the “**Manuals**” folder on the Thermal Imager microSD card (Figure 3-10).

Select a file (image BMP or user manual PDF) to open it, or copy or move files from the Thermal Imager to your PC.

6. When finished, (if required) perform any Windows procedures to “Safely Remove Hardware or Eject Media” to stop communication with the Thermal Imager.
7. Disconnect the USB cable from the PC, and the Thermal Imager.
8. Close the protective cover.



NOTE:

Removing the microSD and using a memory card reader connected to your PC, is an alternate way to transfer images to your PC.

3.4 Expert Tips

The expert tips feature contains helpful troubleshooting tips, and (known good/bad) thermal images that are compiled from actual repairs from experienced technicians, and various independent sources.

The expert tips feature also includes a demonstration mode, that allows you to take a quick look at some of the thermal image examples and tips that are included. See [Demonstration](#) on page 17 for additional information.

**NOTE:**

The tips provided are intended as guidance only.

Expert tips menu options may include various component tips from the following systems:

- Powertrain and Exhaust
 - Body and Electrical
 - Chassis and Brakes
 - HVAC
-

**NOTE:**

When the Thermal Imager is connected by USB cable to a PC, the expert tips feature is disabled. If the expert tips icon is selected while the USB cable is connected to a PC, an error message is displayed. To resume using expert tips, disconnect the USB cable from the PC.

**To access expert tips:**

1. Press the **Menu** button ([Figure 3-11](#)).



Figure 3-11

The menu screen slides open from the top of the screen.

**NOTE:**

You can return to imager mode at anytime by pressing the **Menu** button.

2. Use the **Left** and **Right** (arrow) buttons to select the **expert tips** icon from the toolbar ([Figure 3-12](#)).
3. Press the **Y** button to open the menu.

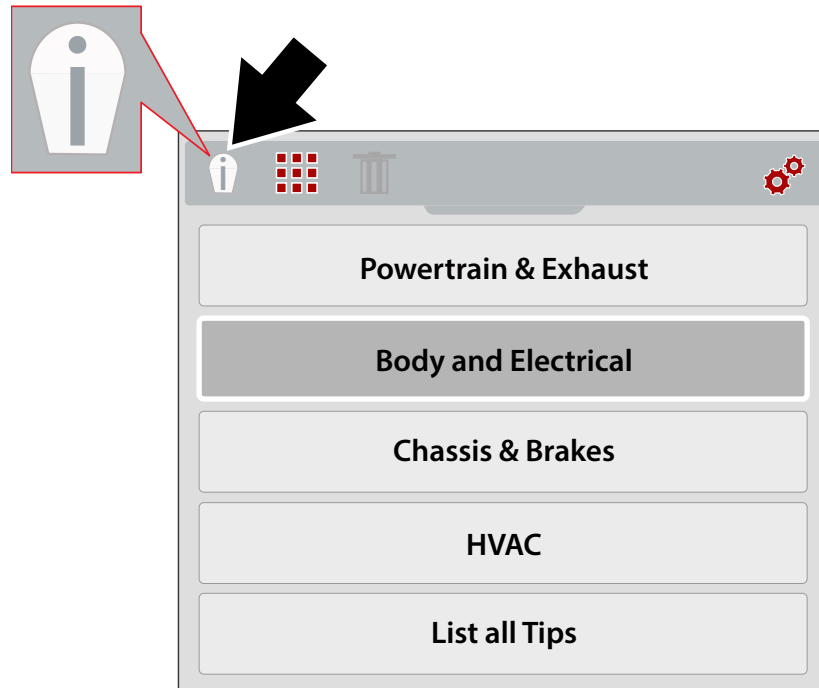

Figure 3-12 Expert Tips Menu (Systems)

4. Use the **Up/Down** directional buttons to select a System from the menu.
5. Press the **Y** button to open the menu.



NOTE:

You can press the **N** button at anytime to go back to the last menu.

The expert tips component menu displays.

6. Select a menu option from the component menu ([Figure 3-13](#)).
7. Press the **Y** button to view the tip results menu.

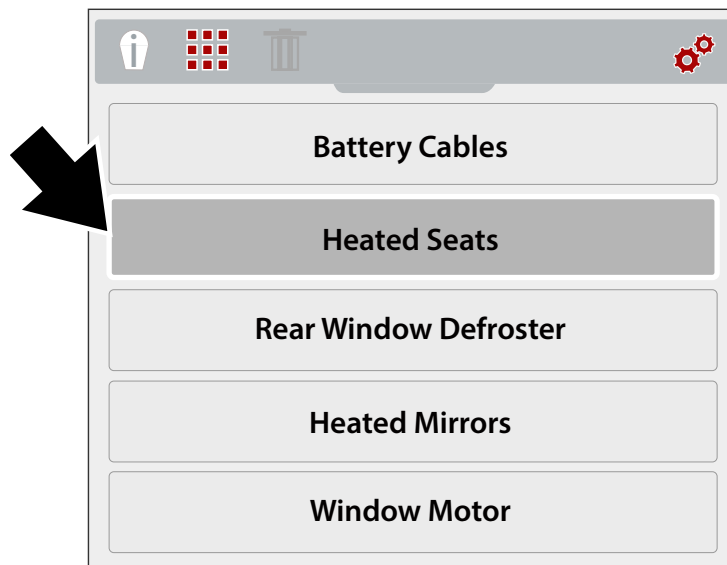

Figure 3-13 Component Menu

- The expert tips results menu displays (Figure 3-14).
8. Select a menu option from the list.
 - **Known Good** - displays a thermal image of the known good component, for comparison
 - **Known Bad** - displays a thermal image of the known bad component, for comparison
 - **Tip** - displays a general component troubleshooting tip
 9. Press the **Y** button to view the image or tip.



NOTE:
 Tips and/or reference images may not be available for all components.

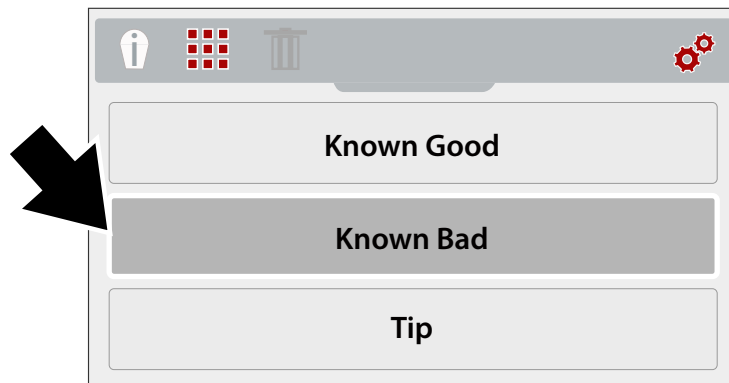

Figure 3-14 Expert Tips Results Menu

Expert tip screen examples are shown in (Figure 3-15).

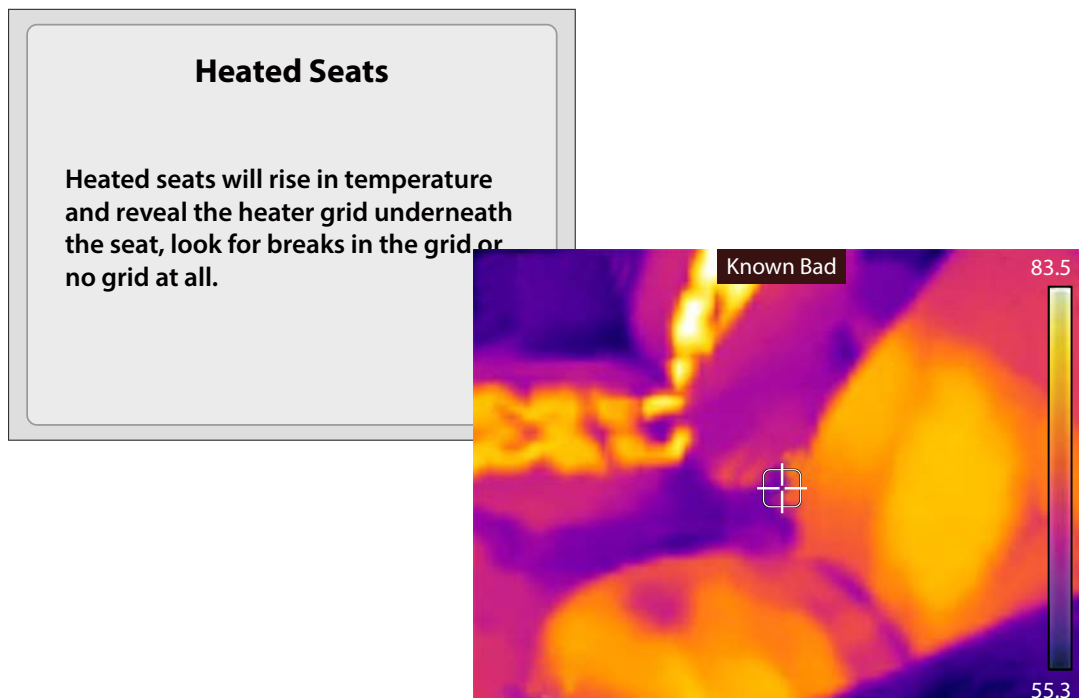

Figure 3-15

**NOTE:**

When viewing expert tip results, use the up/down directional buttons to quickly scroll through the results.

10. When finished, press the **N** button to return to the expert tips menu, or press the **Menu** button to return to imager mode.

3.4.1 Demonstration

The expert tips menu includes a Demonstration option, which allows you to quickly scroll through and view sample thermal images and expert tips.

Demonstration includes the following examples:

- **Heated Seat** (known good image)
 - Heated Seat Testing Tip
- **Alternator** (known good image)
 - Alternator Testing Tip
- **Rear Window Defroster** (known bad image)
 - Rear Window Defroster Testing Tip
- **Differential Bearing** (known bad image)
 - Differential Bearing Inspection Tip
- **Water Pump Bearing** (known bad image)
 - Water Pump Bearing Inspection Tip
- **Alternator Bearing** (known bad image)
 - Alternator Bearing Inspection Tip

**To use Demonstration:**

1. From the expert tips menu, select **Demonstration** (Figure 3-16). See [Expert Tips](#) on page 14 for navigation to the expert tips menu.

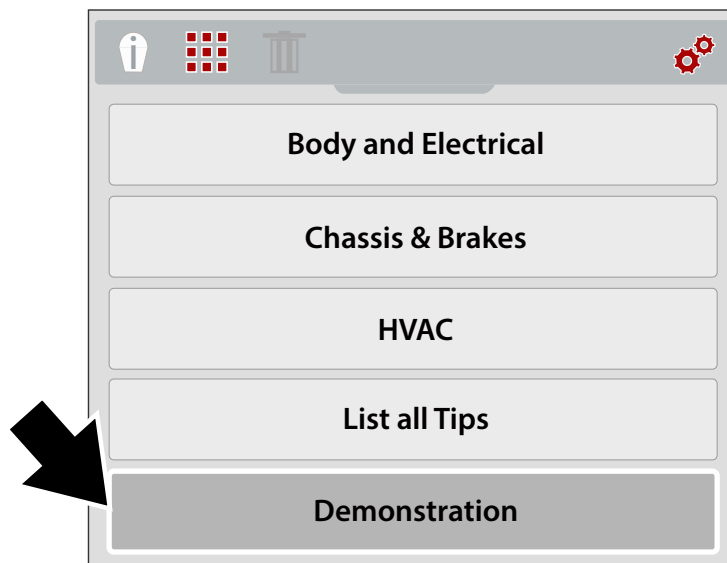

Figure 3-16

The first thermal image example will appear on the screen (Figure 3-17).



Figure 3-17 Demonstration - Thermal Image Example

2. Select the **Down** (arrow) button to view the related expert tip for the image just viewed.
3. Use the **Up** and **Down** (arrow) buttons to scroll through all the thermal image examples and tips.



NOTE:

Scrolling of examples will restart again, after the last image/tip is selected.

4. When finished, press the **N** button to return to the expert tips menu, or press the **Menu** button to return to imager mode.

3.5 Settings

Device settings can be changed using the Settings menu.

The following settings are described in this section:

- [Color Palette](#)
- [Brightness](#)
- [Temperature](#)
- [Power](#)
- [Emissivity](#)
- [Date and Time](#)
- [Navigation Tips](#)
- [About \(Factory Reset\)](#)



To access the settings menu:

1. Press the **Menu** button (Figure 3-18).



Figure 3-18

- The menu screen slides open from the top of the screen.
2. Use the **Left** and **Right** (arrow) buttons to select the **Settings** icon from the toolbar (Figure 3-19).
 3. Press the **Y** button to open the menu.

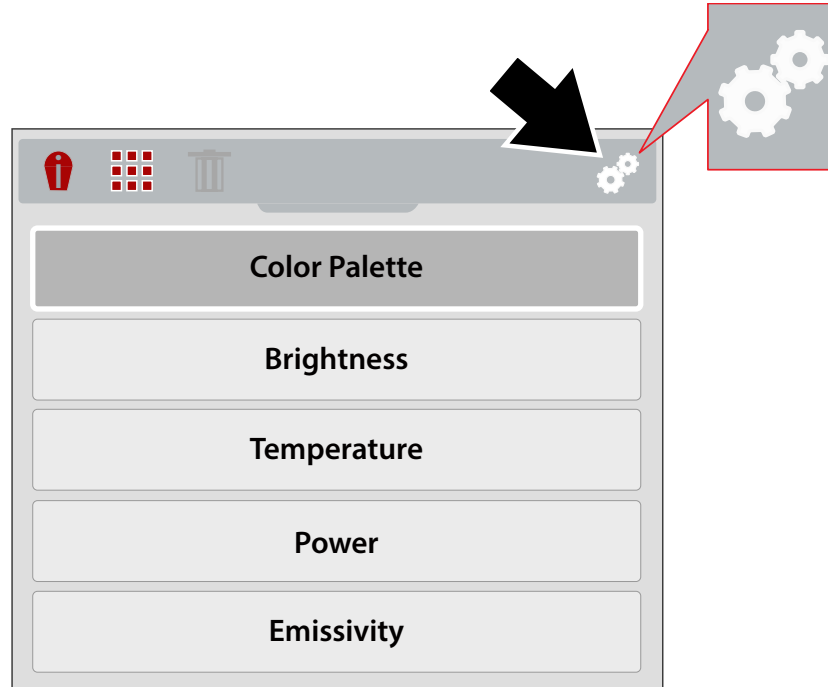

Figure 3-19 Settings Icon

4. Use the **Up/Down** directional buttons to select an option from the menu.



NOTE:

You can return to imager mode at anytime by pressing the **Menu** button.

5. Press the **Y** button to open the selected setting option.

3.5.1 Color Palette

Different color palette themes can be used to help define (enhance) object temperatures by varying color ranges, contrast and brightness. Four color palette presets are available from the menu (Figure 3-20).

Use the **Up/Down** directional buttons to make a selection from the menu, then press the **Y** button to enable the selection, and return to the settings menu.

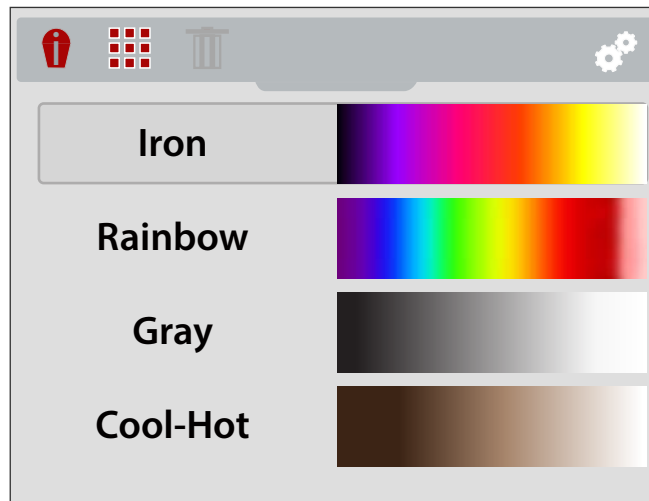

Figure 3-20 Color Palette Settings Menu

3.5.2 Brightness

The **Brightness** setting allows you to set the lighting level of the display (Figure 3-21).

Use the **Up/Down** directional buttons to change the brightness setting. Each press of an **Up/Down button** incrementally changes the lighting level by 10%.

Press the **N** button to return to the settings menu.

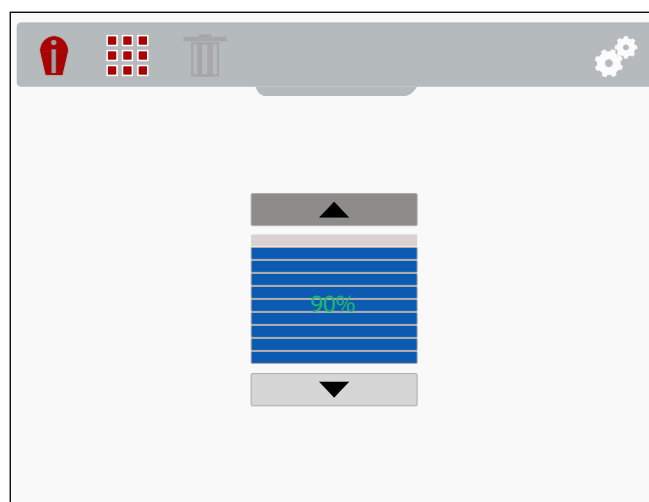

Figure 3-21 Brightness Settings Screen

3.5.3 Temperature

The **Temperature** settings menu allows you to set the temperature unit of measure (°F or °C) (Figure 3-22).

Use the **Up/Down** directional buttons to make a selection from the menu, then press the **Y** button to enable the selection, and return to the settings menu.

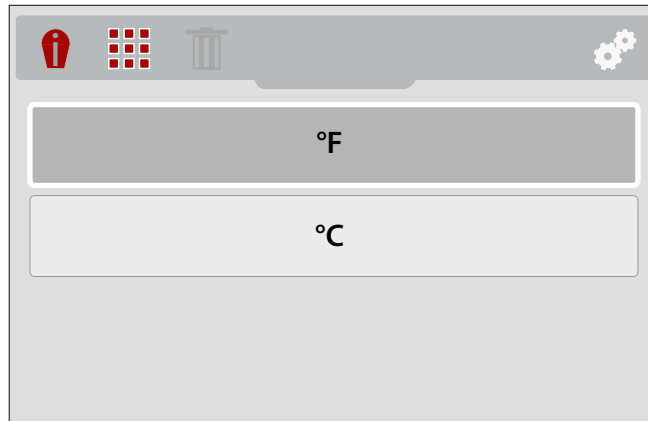

Figure 3-22 Temperature Settings Menu

3.5.4 Power

The **Power** settings menu allows you to set the automated power off time. Four preset options are provided (Figure 3-23).

Use the **Up/Down** directional buttons to make a selection from the menu, then press the **Y** button to enable the selection, and return to the settings menu.

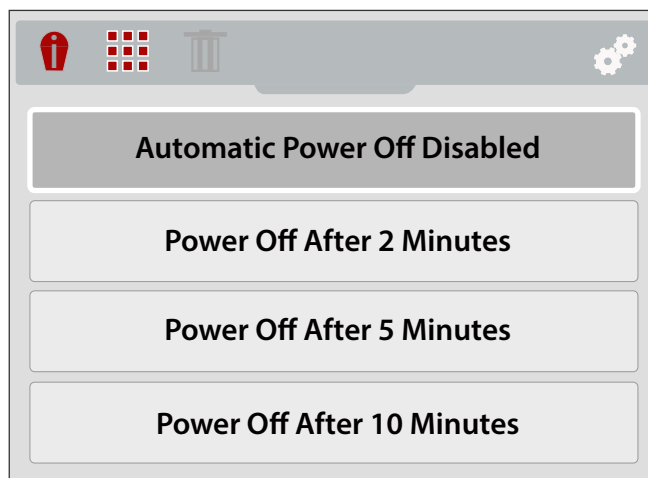

Figure 3-23 Power Settings Menu

3.5.5 Emissivity

The Thermal Imager measures and displays the emitted infrared radiation from an object(s).

To accurately calculate temperature (from infrared radiation), the emissivity value of the object being measured must be entered. The emissivity value is used to effectively calculate the displayed temperature value.

Emissivity is the amount of radiation emitted from an object, compared to that of a perfect blackbody (standard of radiation) of the same temperature.

Emissivity can be effected by other factors (listed below), which is beyond the scope of this manual.

- Core material makeup
- Surface condition
- Temperature
- Angle of view
- Wavelength

As a general rule, objects and surfaces normally exhibit emissivity ranging from approximately 0.1 to 0.95. Materials with smooth (non oxidized) surfaces, usually range from 0.05 to 0.50, however these values may change if the surface is rough or oxidized.

The Thermal Imager is equipped with five common emissivity value presets (Figure 3-25). Choose the most applicable setting for your application.

Use the **Up/Down** directional buttons to make a selection from the menu, then press the **Y** button to enable the selection, and return to the settings menu.

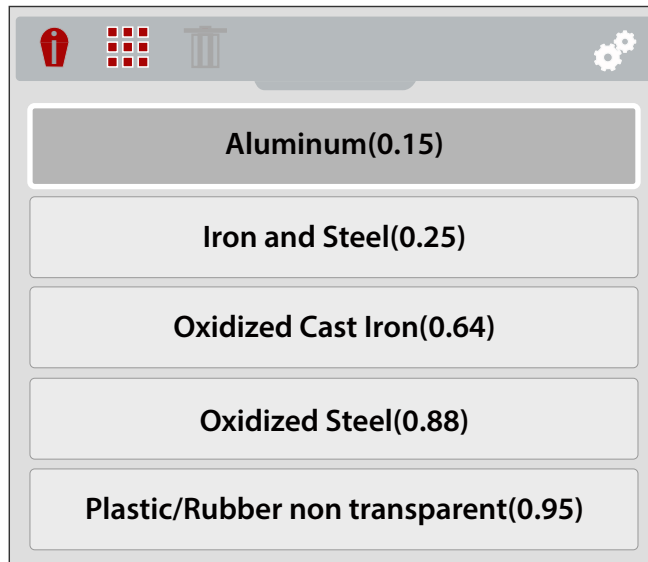

Figure 3-24 Emissivity Settings Menu

3.5.6 Date and Time

Selecting **Date and Time** allows you to set the device system date and time (Figure 3-25).

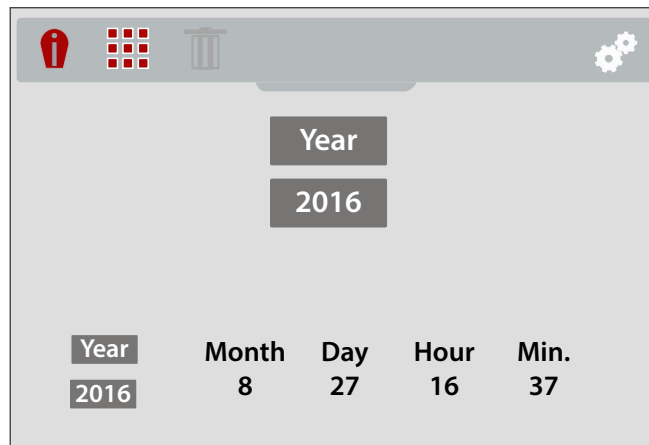

Figure 3-25 Date and Time Settings Screen



To set system date and time:

1. Use the **Up/Down** directional buttons to select the year, month, day, hour and minute. Press the **Y** button after making each selection to continue to the next.
2. After all selections have been made, press the **N** button to return to the settings menu, or press the **Menu** button to return to imager mode.

3.5.7 Navigation Tips

Onscreen navigational tips are provided for select menu navigation procedures, to help you become familiar with the Thermal Imager menus. Each Tip will appear only once after turning on the Thermal Imager.

Selecting **Navigation Tips** from the settings menu allows you to turn on (enable), or turn off (disable) the automated navigational tips (Figure 3-26).

Use the **Up/Down** directional buttons to make a selection (**On** or **Off**) from the menu, then press the **Y** button to enable the selection, and return to the settings menu.

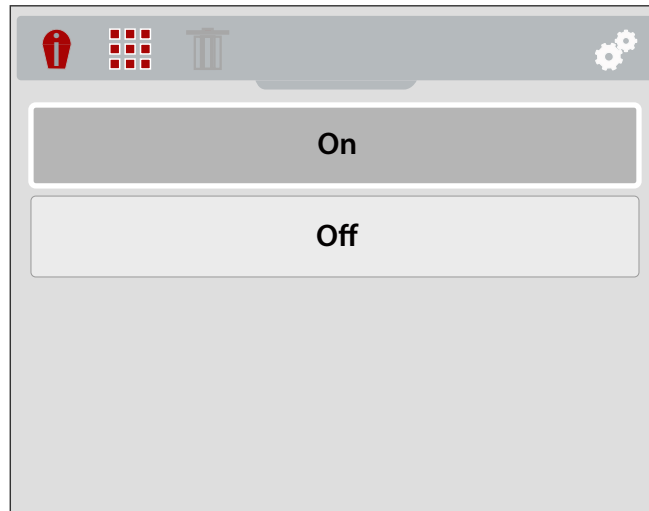

Figure 3-26 Navigational Tips Settings Menu

3.5.8 About (Factory Reset)

Selecting **About** allows you to view hardware and software version information ([Figure 3-27](#)).

Select **Ok**, and then press the **Y** button to return to the settings menu.

Selecting **Factory Reset**, resets all device settings to their factory default setting.

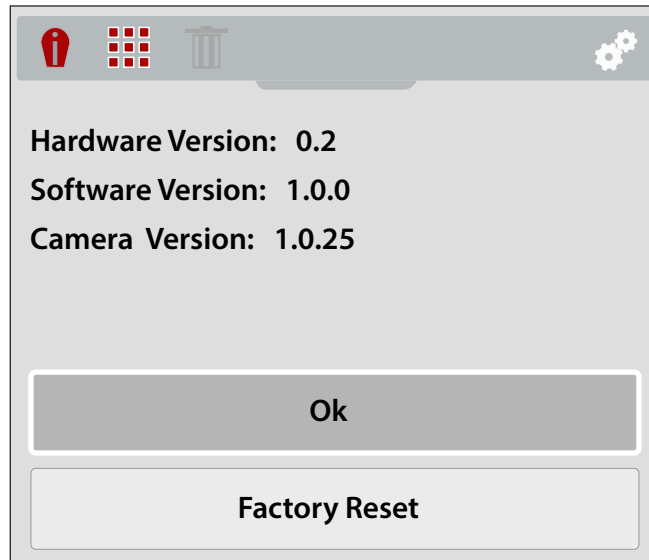

Figure 3-27 About Screen

The information and examples in this chapter are provided to help you become familiar with some of the various uses of the Diagnostic Thermal Imager.

**NOTE:**

The expert tips feature includes reference images of known good and bad vehicle components, see [Expert Tips](#) on page 14 for more information.

(part 1 of 2)

Typical Automotive Component and System Checks	
Powertrain & Exhaust (General Temperature Checks)	Ignition Coils and Exhaust Manifolds (misfire)
	Catalytic Converter
	Pulleys/Bearings - Idler, A/C Compressor, Alternator, Water Pump, etc
	Differential Bearings and Fluid
	Intercooler
	Radiator, Thermostat, Coolant Passages/Hoses/Control Valves
	Heated IAC
	Engine Block Heater
	O2 Sensor Heater
	Glow Plugs
	EGR
	Oil, Transmission and Inverter Coolers/Pumps
Electrical (General Temperature Checks (Open, Short, High Resistance Conditions))	Battery Cables, Wiring, Relays and Switches
	Heated Seats, Mirrors, Wipers and Steering Wheels
	Window, Seat and Wiper Motors
	Alternator Charging
	Rear Window Defroster
	MAF (Hot Wire)
Body (Leak Checks)	Cabin
	Windows/Doors
	Sunroof
Chassis & Brakes (General Temperature Checks)	Bearings
	Brake Rotors/Calipers
	Brake Drums
	Uneven Tire Wear
	Power Steering Cooler/Lines
	Driveshaft Center Support Bearing

(part 2 of 2)

Typical Automotive Component and System Checks	
HVAC (General Temperature and Leak Checks)	General HVAC Conditioned Air Supply Temperature
	Condenser/Compressor
	High and Low Pressure Lines (A/C)
	Blend Doors
	Heater Core
	Blower Motor

4.1 Examples

The thermal images in this section have been modified for clarity. The temperature values, target indicator and color palette have been removed.

4.1.1 Cabin HVAC Leaks

An interior air leak was detected by sealing the vehicle and turning the cabin heat on full. The leak can be seen as heated air escaping the door seal.

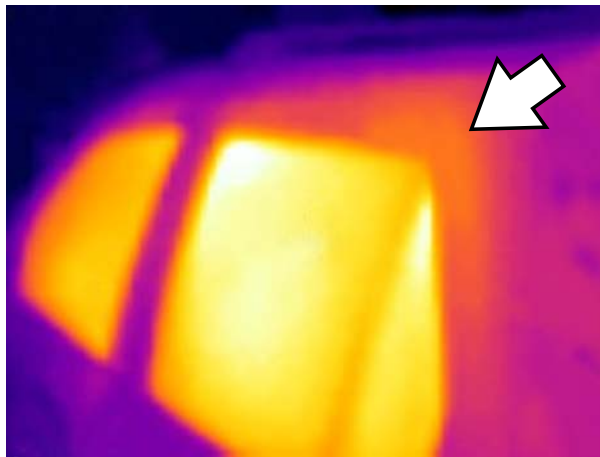

Figure 4-1

4.1.2 Exhaust Manifold Temperature Balance

A misfire was quickly verified by viewing the exhaust manifold. The non-firing cylinder can be identified as a “cold” exhaust runner compared to the others.

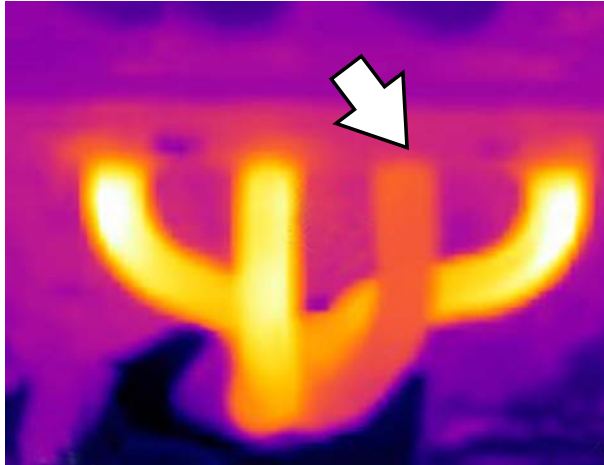

Figure 4-2

4.1.3 Differential Bearing

An overheated (failing) differential bearing was quickly verified by briefly running the vehicle, then viewing the differential. The failing bearing resulted in excessive friction (heat) which can be seen as a bright white/yellow area in the housing.

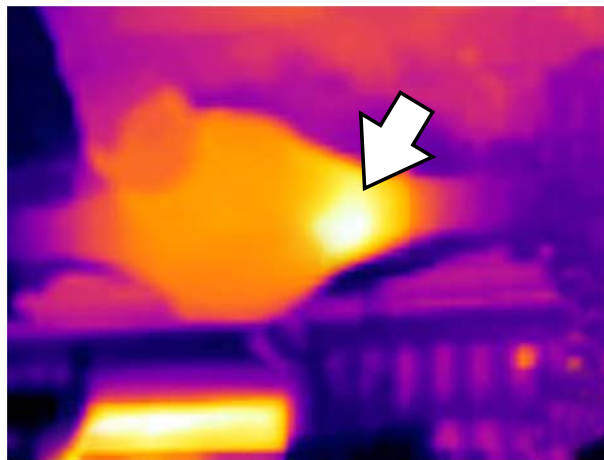

Figure 4-3

4.1.4 Heated Seat Operation

A non-functioning seat heating element was quickly identified by turning on the heated seats, and comparing the seats using the thermal imager.

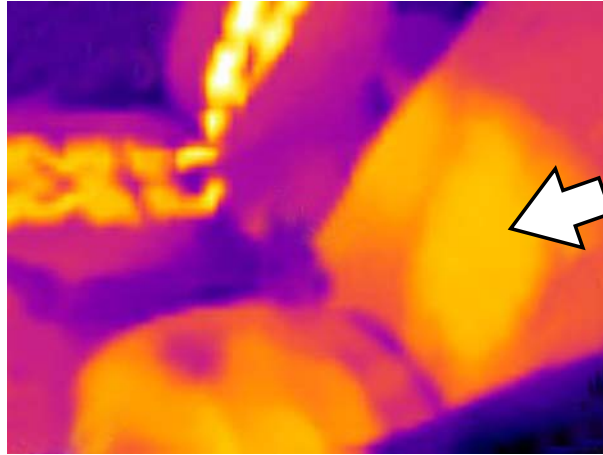

Figure 4-4

4.1.5 Window Defog/Defrost Operation

A break in the grid of the rear window defrost heating element was verified by allowing the element to heat up, then viewing the rear window. The break in the element grid can be seen as a cool area in the window.

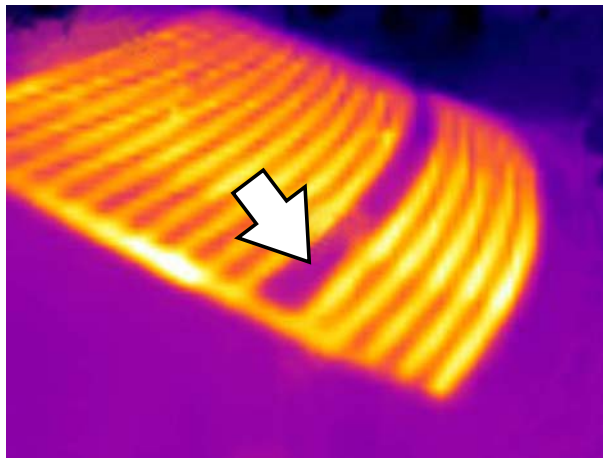

Figure 4-5

4.1.6 Wheel Bearing (Hub Assy.)

An overheated (failing) wheel hub assembly bearing was quickly verified by briefly running the vehicle, then viewing the hub assembly. The failing bearing resulted in excessive friction (heat) which can be seen as a bright white/yellow area on the hub.

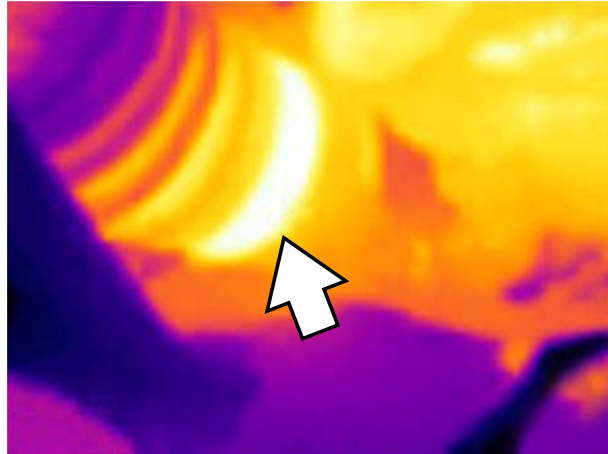

Figure 4-6

This section describes typical maintenance and care procedures for your Thermal Imager.

5.1 Storage

To protect your Thermal Imager, store it in its original custom fit packaging, or in safe area free from dust, moisture and excessive temperatures.

- Only store the Thermal Imager in dry areas, at room temperature.
- During extended periods of non-use (long storage) remove the battery from the Thermal Imager.

5.2 Cleaning

Periodically perform the following tasks to keep your Thermal Imager in proper working order:

- Check the housing, display, and controls for dirt and damage before and after each use.
- Clean the Thermal Imager and display screen with a damp soft cloth and a weak detergent cleaner.

IMPORTANT:

Do not use any abrasive cleansers or automotive chemicals.

IMPORTANT:

When cleaning the imager window, only use a lens cleaning liquid specified for cleaning commercial lenses, that includes more than 30% isopropyl alcohol and is comprised of a minimum of 96% ethyl alcohol. Only use a cotton wool applicator to wipe the window with the solution. Use extreme care when cleaning the window. Avoid touching the window with your fingers, and possibly damaging the window by removing the anti-reflective coating due to oil or debris on your fingers.

5.3 Battery Pack

Follow all safety guidelines when handling the battery pack. Read, understand and follow all safety messages and instructions in this manual, and in the *Important Safety Instructions* supplied with the Thermal Imager.

WARNING



Risk of electric shock.

- **Prior to recycling the battery pack, protect exposed terminals with heavy insulating tape to prevent shorting.**
- **Turn the tool off before removing the battery pack.**
- **Do not attempt to disassemble the battery or remove any component projecting from or protecting the battery terminals.**
- **Do not expose the tool or battery pack to rain, snow, or wet conditions.**
- **Do not short circuit the battery terminals.**

Electric shock can cause injury.

WARNING



Risk of explosion.

- **Only use the Snap-on lithium-ion battery approved for this device. Do not use any other battery or power adapter source. Incorrect replacement, charging, or tampering with the battery pack may cause an explosion.**

Explosion can cause death or serious injury.

5.3.1 Safety Guidelines

IMPORTANT:

The battery pack contains no user serviceable components. Tampering with the battery pack terminals or housing will void the product warranty.

Keep the following in mind when using and handling the battery pack:

- Do not short circuit battery pack terminals.
- Do not immerse the Thermal Imager or battery pack in water, or allow water to enter the Thermal Imager or battery pack.
- Do not crush, disassemble, or tamper with the battery pack.
- Do not heat the battery pack to over 100°C (212°F), or dispose of it in a fire.
- Do not expose the battery pack to excessive physical shock or vibration.
- Keep the battery pack out of reach of children.
- Do not use a battery pack that appears to have suffered abuse or damage.
- Charge the battery pack using the appropriate charger only.
- Do not use a battery charger adapter that has been modified or damaged.
- Use the battery pack for the specified product only.
- Store the battery pack in a cool, dry, well ventilated area.

5.3.2 Charging

The Thermal Imager is powered by an internal rechargeable battery pack, and has a built in charger that recharges the battery on demand whenever it is connected to a power source. A fully charged battery pack can provide up to 4 hours of continuous operation (brightness level setting at 50%).

To prolong the life of your battery, turn off the Thermal Imager when not in use.

IMPORTANT:

A protective cover is used over the USB jack and microSD card slot, located on top of the Imager. Always keep the protective cover closed during operation. Only open the protective cover during battery charging, or when removing the microSD card. Opening the protective cover during operation could result in an electrostatic discharge event that may cause the Thermal Imager to reset. If this occurs, the Thermal Imager will reset and return to normal operation without being damaged.

**NOTE:**

The battery pack should be used within a short period of time (about 30 days) after charging to prevent loss of capacity due to self-discharging.

**To Charge the battery pack:**

1. Open the protective cover on top of the Thermal Imager.
-

**NOTE:**

The protective cover used over the microSD and USB jack is not shown for clarity purposes in (Figure 5-1).

2. With the battery pack installed in the Thermal Imager, connect the USB cable to the micro USB jack on the Thermal Imager (Figure 5-1).

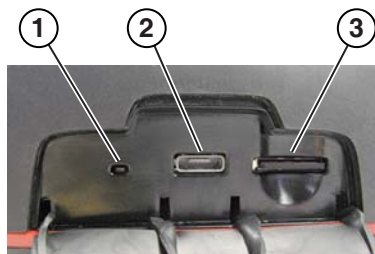

- 1— Battery Charging LED Indicator
2— micro USB Jack (USB power supply connection)
3— microSD Card

Figure 5-1 Features (top)

IMPORTANT:

Only use the supplied USB power supply adapter. Use of a non-approved power supply adapter will cause damage.

3. Connect the USB cable to the USB power supply adapter.
4. Connect the USB power supply adapter, to a live AC power source.





NOTE:

The battery pack will also charge when the USB cable is connected to a PC (using the power supplied from the PC's USB connection).

5. The battery charging LED (located on the top of the Thermal Imager) will be lit during charging (Figure 5-1).

The battery level icon (located in the upper right corner of the screen) indicates the charge level of the battery, and when the battery is being charged.

Table 5-1 Battery Icons

Icon	Function
	<p>Full Battery Charge Level - Indicates power is being supplied by the internal battery pack. Horizontal bars diminish as the battery discharges.</p> <p>When the battery charge level drops to approximately 10 minutes of power left, the icon will flash on/off as a reminder to connect the USB power supply adapter. If the charger is not connected, the unit will continue operate until it automatically turns off, due to low power. A warning message will be displayed before shutdown, "Low Battery - The unit will power down in 30 seconds, please connect to a charger."</p>
	<p>External Power Connected - Indicates power is being supplied by the USB power supply adapter to charge the battery pack.</p>



NOTE:

If the battery pack no longer holds a charge, contact your sales representative to order a new one.

6. Close the protective cover, when finished.

5.3.3 Remove/Install

IMPORTANT:

Replace the battery pack with a Snap-on replacement battery pack only.

**To remove the battery pack:**

1. Insert the end of a small flat bladed screwdriver into the notch located at the rear of the battery pack cover, and gently pry up on the cover to remove (Figure 5-2).

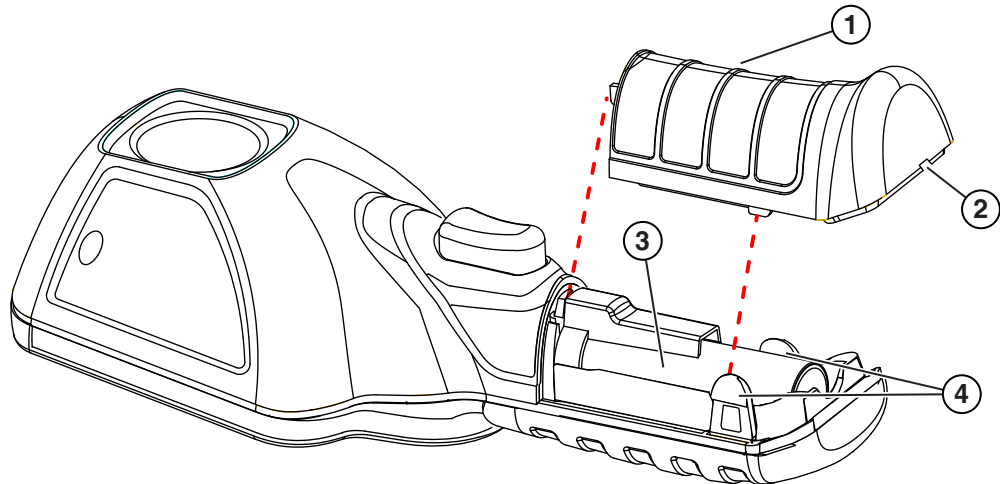

- 1— Battery Pack Cover
- 2— Notch (Pry up to remove)
- 3— Battery Pack
- 4— Locking Tabs

Figure 5-2

2. Carefully lift out the battery pack, then press down on the battery lead connector release tab and remove the connector from the battery pack (Figure 5-3).

IMPORTANT:

Do not pull the battery harness out of the housing.

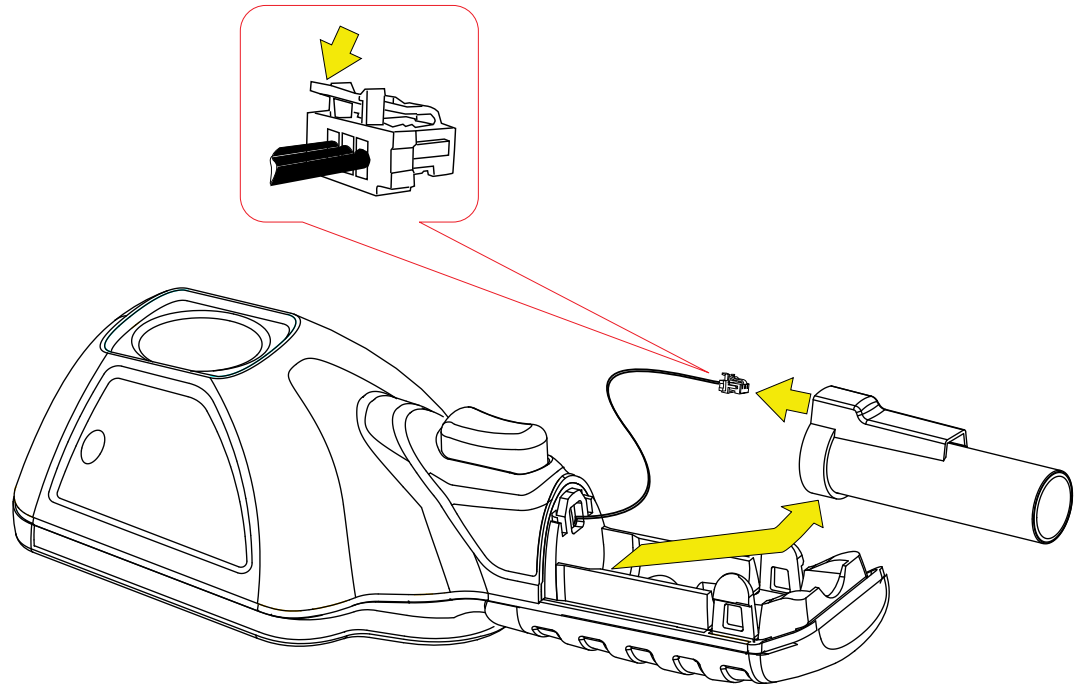

Figure 5-3

**To install the battery pack:**

1. Insert the battery connector into the battery pack, until it locks (clicks) into place.

**NOTE:**

Do not force the battery pack into the Thermal Imager, it should set easily into place.

2. Feed the slacked harness into housing, as you install the battery pack into the housing (Figure 5-4).

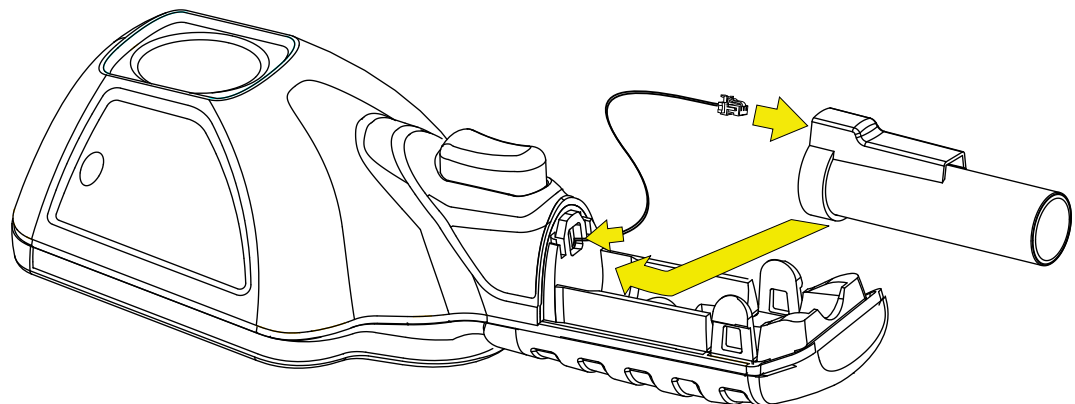

Figure 5-4

3. Install the battery cover. Press down until the locking tabs secure the cover (Figure 5-5).

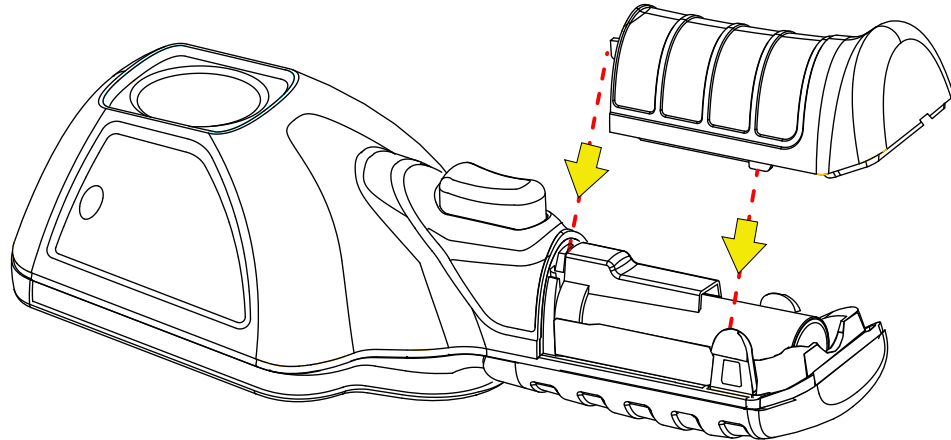

Figure 5-5



NOTE:

Date and time settings will need to be reset whenever the battery is reconnected after being disconnected.

5.3.4 Ordering a Replacement Battery

Contact your sales representative to order a replacement battery.

IMPORTANT:

Replace the battery pack with a Snap-on replacement battery pack only.

5.3.5 Disposal

Always dispose of a lithium-ion battery pack according to local regulations, which vary for different countries and regions. The battery pack, while non-hazardous waste, does contain recyclable materials. If shipping is required, ship the battery pack to a recycling facility in accordance with local, national, and international regulations. For additional information contact:

- **North America**—Rechargeable Battery Recycling Corporation (RBRC) at <http://www.rbrc.org> or <http://www.call2recycle.org>, or call 1(800) 822-8837 (USA)
- **United Kingdom**—Electrical Waste Recycling Company at <http://www.electricalwaste.com>
- **Australia** - Australian Battery Recycling Initiative <http://www.batteryrecycling.org.au>
- **New Zealand** - Ministry for the Environment <https://www.mfe.govt.nz/issues/waste/streams/batteries.html>

Products bearing the WEEE logo (Figure 5-6) are subject to European Union regulations.



Figure 5-6 sample WEEE logo



NOTE:

Always dispose of materials according to local regulations.

Contact your sales representative for details.

This chapter includes basic troubleshooting, and possible solutions for issues that may arise when operating the Thermal Imager.

6.1 Troubleshooting Chart

Table 6-1

Problem	Checks / Remedy
Will not turn on	<p>a.) Battery is not installed or has become disconnected. Install the battery, or remove and reinstall the battery to establish connection.</p> <p>b.) Battery is discharged or is defective. Recharge battery or replace with known good fully charged battery.</p>
Battery performance is poor	Battery may be defective. Replace battery.
Poor or no image	<p>a.) Color palette setting is incorrect. Change the color palette setting.</p> <p>b.) Emissivity setting is incorrect. Change the emissivity setting.</p> <p>c.) Condensation or debris on imager window. Clean window or place imager in a dry area at room temperature until condensation clears.</p>
Temperature measurement is inaccurate	<p>a.) Emissivity setting is incorrect. Change the emissivity setting.</p> <p>b.) Condensation or debris on imager window. Clean window or place imager in a dry area at room temperature until condensation clears.</p>
Temperature measurement display is non-responsive	<p>a.) If the ">" symbol displays in front of the Center Region Temperature (Average) value, this indicates the maximum measurable temperature has been reached (e.g. >840°F (>450 °C)).</p> <p>b.) The Thermal Imager may be performing an automatic calibration. Wait a few seconds and retry, if still no response turn the unit off then back on.</p>
Image are not being saved	When the microSD is full, and the screen capture trigger is pulled, the last saved image will be deleted. To resume operation, delete images from the microSD card, or move them off the microSD card to a PC.
"Disconnect the USB cable from the PC and retry" or "Unable to save image" message is displayed onscreen	When the Thermal Imager is connected by USB cable to a PC, saving and viewing images is disabled. If the screen capture trigger is pulled, or the gallery icon is selected while the USB cable is connected to a PC, an error message is displayed. To resume operation, disconnect the USB cable from the PC.
"microSD card is not installed" message is displayed onscreen	The microSD card must be installed in order to save images and view expert tips. Install the supplied microSD card.