



User Manual

August 2013

ZEETM303D Rev. D

Trademarks Acknowledgements

Snap-on and Vantage PRO are trademarks of Snap-on Incorporated.

All other marks are trademarks or registered trademarks of their respective holders.

Copyright Information

©2013 Snap-on Incorporated

All rights reserved.

Disclaimer

The information, specifications and illustrations in this manual are based on the latest information available at the time of printing.

Snap-on reserves the right to make changes at any time without notice.

Visit our website at:

<http://diagnostics.snapon.com> (North America)

www1.snapon.com/diagnostics/uk (United Kingdom)

snapontools.com.au (Australia and New Zealand)

For Technical Assistance

CALL 1-800-424-7226 (North America)

CALL +44 (0) 845 601 4736 (United Kingdom)

1800 810 581 (Australia and New Zealand)

E-mail DiagnosicsUKproductsupport@snapon.com (United Kingdom)

For technical assistance in all other markets, contact your selling agent.

EC-DECLARATION OF CONFORMITY

We,

Snap-on Diagnostics
a division of Snap-on UK Holdings Ltd.
Denney Road, King's Lynn
Norfolk, PE30 4HG
England

declare under our sole responsibility for design and manufacture that the following product, to which this declaration relates, is in conformity with the following European Directives:

EMC Directive: EN61326-1 (2006)4, EN61000-3-2 (2006), EN61000-3-3 (1995)

Product: Vantage-PRO

Model: EETM303 Diagnostic Platform

Applied Safety standard: IEC 61010-1, EN 61010-1

King's Lynn, 23-07-2009

Name : C. Ferra

Position : Supply Chain Manager

Signature : 

Safety Information

For your own safety and the safety of others, and to prevent damage to the equipment and vehicles upon which it is used, it is important that the accompanying *Important Safety Instructions* be read and understood by all persons operating, or coming into contact with, the equipment. We suggest you store a copy near the unit in sight of the operator

This product is intended for use by properly trained and skilled professional automotive technicians. The safety messages presented throughout this manual are reminders to the operator to exercise extreme care when using this test instrument.

There are many variations in procedures, techniques, tools, and parts for servicing vehicles, as well as in the skill of the individual doing the work. Because of the vast number of test applications and variations in the products that can be tested with this instrument, we cannot possibly anticipate or provide advice or safety messages to cover every situation. It is the automotive technician's responsibility to be knowledgeable of the system being tested. It is essential to use proper service methods and test procedures. It is important to perform tests in an appropriate and acceptable manner that does not endanger your safety, the safety of others in the work area, the equipment being used, or the vehicle being tested.

It is assumed that the operator has a thorough understanding of vehicle systems before using this product. Understanding of these system principles and operating theories is necessary for competent, safe and accurate use of this instrument.

Before using the equipment, always refer to and follow the safety messages and applicable test procedures provided by the manufacturer of the vehicle or equipment being tested. Use the equipment only as described in this manual.

Read, understand and follow all safety messages and instructions in this manual, the accompanying safety manual, and on the test equipment.

Safety Message Conventions

Safety messages are provided to help prevent personal injury and equipment damage. All safety messages are introduced by a signal word indicating the hazard level.

DANGER

Indicates an imminently hazardous situation which, if not avoided, will result in death or serious injury to the operator or to bystanders.

WARNING

Indicates a potentially hazardous situation which, if not avoided, could result in death or serious injury to the operator or to bystanders.

CAUTION

Indicates a potentially hazardous situation which, if not avoided, may result in moderate or minor injury to the operator or to bystanders.

Safety messages contain three different type styles.

- Normal type states the hazard.
- Bold type states how to avoid the hazard.
- Italic type states the possible consequences of not avoiding the hazard.

An icon, when present, gives a graphical description of the potential hazard.

Example:

 **WARNING**



Risk of unexpected vehicle movement.

- **Block drive wheels before performing a test with engine running.**

A moving vehicle can cause injury.

Important Safety Instructions

For a complete list of safety messages, refer to the accompanying safety manual.

SAVE THESE INSTRUCTIONS

Contents

Safety Information	iv
Contents	vi
Chapter 1: Using This Manual	1
Conventions	1
Bold Text	1
Symbols	1
Terminology	2
Notes and Important Messages	2
Procedures	2
Tool Help	3
Chapter 2: Introduction	4
Functional Description	4
The Stand	6
Technical Specifications	7
Operating Specifications	7
Scope Capabilities	8
Test Instrument Capabilities	8
Control Buttons	11
Y/✓ (Yes) Button	11
N/X (No) Button	11
Thumb Pad	12
Brightness/Contrast Button	12
S Button	12
Power Button	12
Connections	12
Test Lead Jacks	12
DC Power Jack	13
USB Port	13
Power Sources	13
AC/DC Power Adapter	13
Battery Pack	14
Battery Charger	14
Vehicle Auxiliary Power Cables (Optional)	14
Leads and Clips	15
Channel 1 Lead	15
Channel 2 Lead	16
Alligator Clips	16
Chapter 3: Getting Started	17
Supplying Power	17
Using the Battery Pack	17
Connecting the AC/DC Power Adapter	19

Connecting Vehicle Auxiliary Power Cables	19
Powering On the Unit	20
Adjusting Brightness and Contrast	20
Connecting Leads and Clips.....	21
Setting Up to Print	22
Connecting to a Computer.....	22
Powering Off the Unit	22
Chapter 4: Navigation	24
Screen Layout	24
Upper Toolbar	24
Main Body	26
Lower Toolbar	26
Status Bar	27
Making Selections	27
Navigating Multi-Window Screens	28
Easy Scroll.....	29
Screen Messages.....	30
Confirmation Messages	30
Warning Messages	30
Error Messages.....	30
Chapter 5: Component Test Operations	31
Component Tests	31
Identifying the Test Vehicle	32
New Vehicle ID	32
Previous Vehicles	33
Selecting a Component Test	34
Connecting to a Test Vehicle.....	35
Performing Tests	35
Changing Views	36
Pausing Data	37
Reviewing Data.....	38
Using Zoom.....	38
Using Cursors	39
Taking Snapshots	40
Resetting Gauges	42
Saving Data	43
Printing.....	44
Using Setup	44
Units.....	45
Calibration LED.....	50
Adjusting Channel Settings.....	50
Setting the Sweep Time.....	54
Setting the Trigger	55
Trigger Position.....	57
Viewing Component Information	57
Identifying the Vehicle.....	58
Viewing Component Information.....	58
Features and Benefits	59

How To	60
Power User Tests	60
Chapter 6: Multimeter Operations.....	61
Selecting Multimeter Software.....	62
Graphing Meter	62
Digital Meter	63
Performing Multimeter Tests	65
Chapter 7: Scope Operations	66
Selecting Scope Software	67
Lab Scope.....	67
Ignition Scope	69
Performing Scope Tests.....	73
Using Presets	74
Loading Saved Presets	75
Editing Presets	76
Deleting Presets.....	77
Copying and Moving Presets	78
Selecting Multiple Presets.....	79
Chapter 8: Data Management	80
Identifying Saved Files	81
Loading Saved Files	81
Editing Saved Files.....	82
Deleting Saved Files.....	83
Copying and Moving Saved Data	84
Selecting All Files	85
Backing up Saved Files	85
Chapter 9: Utilities	86
Tool Setup	86
Units.....	87
Ignition System	88
Power Management.....	88
Save Data	89
Printer	90
Date	90
Time	91
S Button	91
Color Theme	92
System Tools.....	92
Add Program	93
System Restore	93
Tool Help	93
Easy Scroll.....	94
Connect to PC	95
Run	95
Shop Info	95
System Info.....	96

Chapter 10: Maintenance	97
Cleaning and Damage Inspection	97
Battery Pack	97
Replacing the Battery Pack.....	97
10-Amp Fuse	97
CompactFlash® (CF) Cards	98
Storage Tips	98
Disposal Requirements	98
Appendix A: Troubleshooting	99
Battery Pack Not Charging	99
Unit Will Not Power On.....	99
Emergency Restart.....	99
Appendix B: Using Peak Detect	101
When To Use Peak Detect	101
Example—Testing Secondary Ignition	101
Example—Testing a TPS for Glitches.....	103
When Not to Use Peak Detect.....	104
Example—Testing an Oxygen Sensor	104
Peak Detect and the Graphing Meter	105
Appendix C: Using Noise Filter	106
When to Use Filter	106
Graphing Meter Filter Use.....	106
Scope Filter Use	109
Appendix D: Using Sensitivity Adjustment	110
When To Use Sensitivity Adjustment	110
Improper Sensitivity Adjustments.....	110
Some Common Ignition Problems.....	113
Example—Vehicle With A Shorted Spark-Plug	113
Example—Vehicle With A Coil Not Firing	114
Index	116

This manual contains instructions for using the Vantage PRO unit.

Some of the illustrations shown in this manual may contain options that are not included on your system. Contact a sales representative for availability.

1.1 Conventions

The following conventions are used.

1.1.1 Bold Text

Bold emphasis is used in procedures to highlight selectable items such as buttons and menu options.

Example:

- Press the **Y/✓** button.

1.1.2 Symbols

The following types of arrows are used.

The “greater than” arrow (>) indicates an abbreviated set of selection instructions.

Example:

- Select **Utilities > Tool Setup > Date**.

The above statement abbreviates the following procedure:

1. Navigate to the **Utilities** button.
2. Use the Thumb Pad to navigate to and highlight the **Tool Setup** submenu.
3. Use the Thumb Pad to navigate to and highlight the **Date** option from the submenu.
4. Press **Y/✓** to confirm the selection.

The solid arrows (◀, ▶, ▼, ▲) refer to the four directions of the Thumb Pad.

Example:

- Press the down ▼ arrow.

1.1.3 Terminology

The term “select” means to highlight a button or menu item using the Thumb Pad, and then pressing the **Y/✓** button to confirm the selection.

Example:

- Select **Reset**.

The above statement abbreviates the following procedure:

1. Navigate to and highlight the **Reset** button.
2. Press the **Y/✓** button.

1.1.4 Notes and Important Messages

The following messages are used.

Notes

A NOTE provides helpful information such as additional explanations, tips, and comments.

Example:

**NOTE:**

For additional information refer to...

Important

IMPORTANT indicates a situation which, if not avoided, may result in damage to the test equipment or vehicle.

Example:

IMPORTANT:

Do not force the CompactFlash[®] card into the slot.

1.1.5 Procedures

An arrow icon indicates a procedure.

Example:

**To change screen views:**

1. Select the **View button**.
The dropdown menu displays.
2. Select an option from the menu.
The screen layout changes to the format you selected.

1.2 Tool Help

Your Vantage PRO unit Tool Help contains reference and procedural information found in this manual. From the main menu, access Tool Help on the Utilities menu. See “Tool Help” on page 93 for details.

The Vantage PRO unit (Figure 2-1) combines a digital and graphing multimeter, lab scope and ignition scope with a powerful diagnostic database.

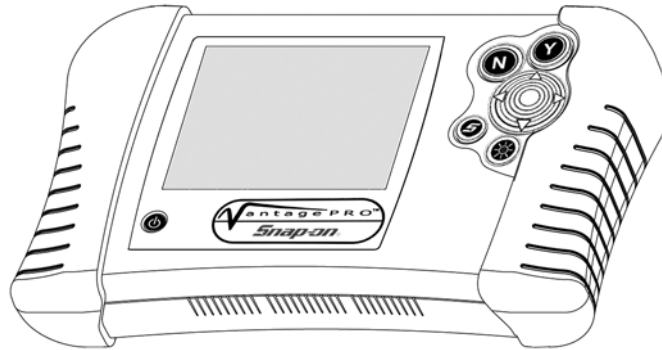

Figure 2-1 Vantage PRO

This diagnostic database gives you component-specific test information and automatically configures the tool for any selected test. A multi-window format lets you simultaneously view instrumentation readings and component-specific test help information.

2.1 Functional Description

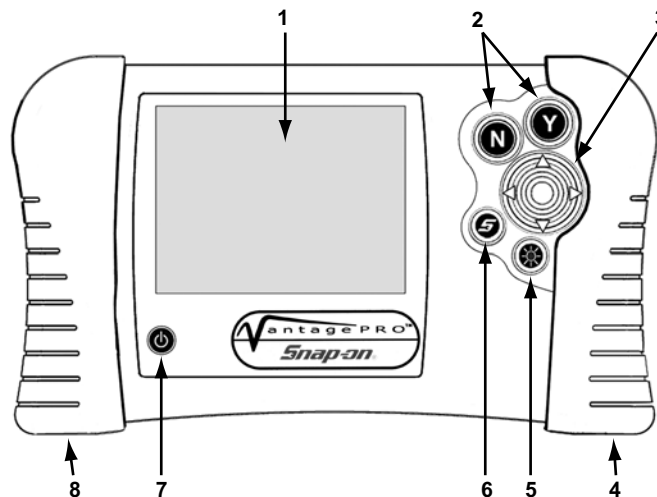

Figure 2-2 Vantage PRO unit front view

- 1— Transfective screen
- 2— N/X (No) and Y/✓ (Yes) buttons
- 3— Thumb Pad

- 4— Right handgrip
- 5— Brightness/Contrast button
- 6— S button
- 7— Power button
- 8— Left handgrip

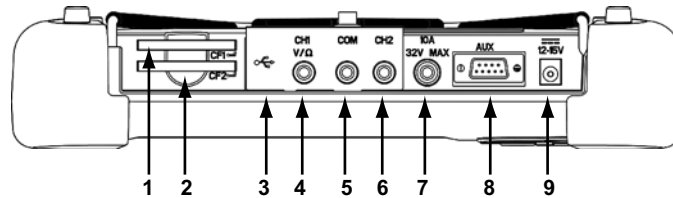

Figure 2-3 Vantage PRO unit top view

- 1— **CompactFlash® (CF) Card Slot 1**
Master program CF card slot (no hot swapping).
- 2— **CF Card Slot 2**
Supports I/O hot swapping.
- 3— **USB ports**
Protected by sliding shield. For printer, keyboard, mouse or PC computer.
- 4— **Channel 1 (CH1, yellow)**
V/Ω/Diode/Hz/PW/F-INJ PW Duty Cycle%, 200V max.
- 5— **Common ground (COM, black)**
- 6— **Channel 2 (CH2, green)**
VDC, 200V max.
- 7— **Amps (10A, blue)**
32VDC max.
- 8— **Aux Port**
DB9F connectors, such as the split lead adapter or the inductive rpm pickup.
- 9— **DC power jack**

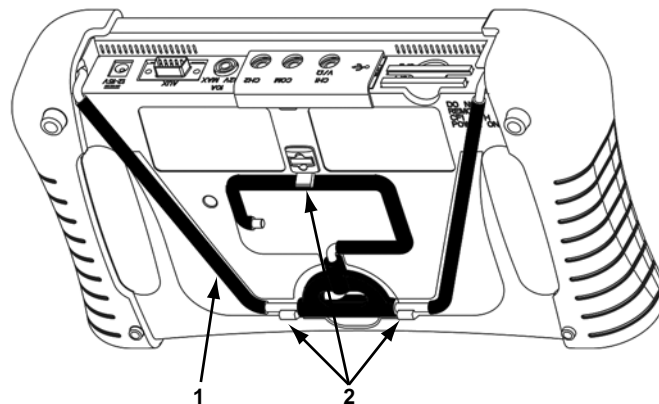

Figure 2-4 Vantage PRO unit back view

- 1— **Stand**
- 2— **Casing hooks**

2.2 The Stand

The Vantage PRO unit has a built-in metal stand attached to the back. When the stand is not in use, it is secured to the back of the unit by integrated casing hooks.

When extended, the stand allows the unit to rest at a 45° angle for hands-free viewing (Figure 2-5).

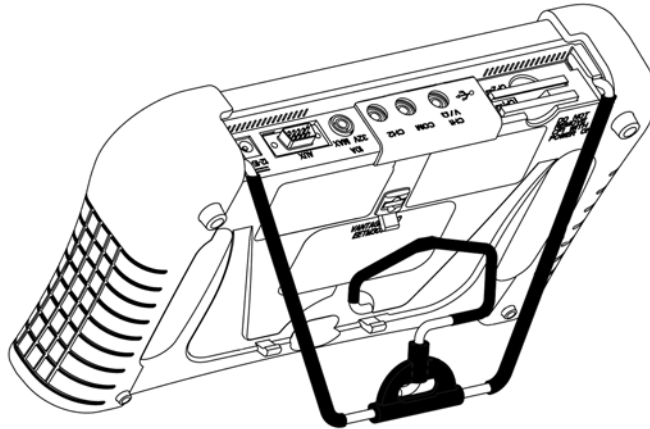

Figure 2-5 Vantage PRO unit with stand extended

The stand can also be extended to a hanging position by pressing the left side towards the right and rotating forward (Figure 2-6).

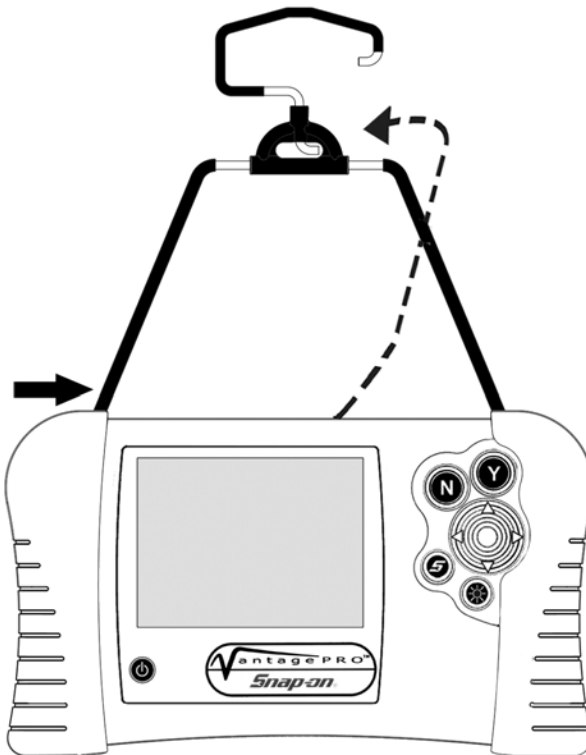

Figure 2-6 Vantage PRO unit with stand in hanging position

2.3 Technical Specifications

Display:

Transflective Liquid Crystal Display (LCD)

Visible under any lighting condition

320 x 240 resolution (1/4 VGA)

256 colors

5.7 inches (144.8 mm)

CompactFlash® (CF) Card Slot:

CF Type 1

Slot 1 is for the master program CF card

Slot 2 is for user options, such as a storage CF card

Battery Pack:

Nickel-metal hydride

Rechargeable

External Battery Charger:

Input: 100–240 V AC @ 0.5A, 47–63 Hz

Fuse:

10 Amp ATO® Mini

AC/DC Adapter:

2.5 mm DC plug

Input: 100–240V AC @ 0.5A, 47–63 Hz

Output: 15V DC @ 1.2A

Dimensions:

Width: 11.75 inches (298.45 mm)

Height: 6.90 inches (175.26 mm)

Depth: 2.40 inches (60.96 mm)

Weight (including battery pack):

3 lbs 12.5 oz (1.509 Kg)

Operating Temperature Range:

32 to 122°F (0 to 50°C)

Storage Temperature Range:

–4 to 140°F (–20 to 60°C)

2.4 Operating Specifications

The following tables detail the Vantage PRO unit operating specifications for:

- Scope capabilities
- Test instrument capabilities

2.4.1 Scope Capabilities

The following tables (Table 2-1 and Table 2-2) detail the Scope capabilities for:

- Analog to digital (A/D) conversions
- Horizontal sweep and frame storage

Table 2-1 Scope: Analog to digital conversions

Function	Range	Accuracy/comments
Channels	2	Common grounds
Sample Rate	8 Msps	Maximum
Resolution	12 bits	

Table 2-2 Scope: Horizontal sweep and frame storage

Sweep	Data Points per Channel	Buffer Storage* per Channel
50 μ s	200	1305 screens (262 K data points)
100 μ s –20 s	250	1048 screens (262 K data points)
†Buffer storage consists of contiguous screens of 2 channel data.		

2.4.2 Test Instrument Capabilities

Test instrument capabilities are shown in the table below.

Function	Range	Resolution	Accuracy ¹
Amps (Internal)	1 A	0.001 A	+(1.5% + 2 digits)
	2 A	0.01 A	+(1.0% + 2 digits)
	5 A		
	10 A		
Diode/ Continuity	2.5	0.002 V	+(1% + 2 digits)
¹ Accuracy, measured at 25°C, is shown as \pm (% of reading) + (Number of least significant digits). For example, a 100V DC signal accuracy reading would be \pm (0.25% + 2 digits), or 99.75 to 100.25 \pm 2 digits; or 99.73 to 100.27.			

Function	Range	Resolution	Accuracy ¹
Duty-cycle	20	1Hz–1500Hz: 0.1%	1Hz–9kHz + (1% + 2 digits) 9001Hz–20kHz + (2% + 2 digits)
	40	1501Hz–3000Hz: 0.2%	
	60	3001Hz–7500Hz: 0.5%	
	80	750Hz–15kHz: 1%	
	100	15001Hz–20kHz: 1.5%	
Frequency Hz	5	0.01Hz	+(0.25% + 2 digits)
	10		
	50		
	100	0.1Hz	+(0.5% + 2 digits)
	250	0.1Hz	
	500	1Hz	
	1000	1Hz	
	2000	3Hz	+(1.5% + 2 digits)
	5000	20Hz	
	10000	100Hz	
	20000	300Hz	+(3.5% + 2 digits)
50000	1800Hz		
Ignition scope	2000	5V	—
	3000		
	5000		
	10000		
	15000	50V	
	20000		
	50000		
MC Dwell degrees	20	0.1°	+(0.5% + 2 digits)
	40		
	60		
Ohms	40	0.05	+(1.5% + 2 digits)
	400	1	
	4k	10	
	40k	100	
	400k	1k	
	4M	10k	+(2.0% + 2 digits)
¹ Accuracy, measured at 25°C, is shown as ± (% of reading) + (Number of least significant digits). For example, a 100V DC signal accuracy reading would be ± (0.25% + 2 digits), or 99.75 to 100.25 ± 2 digits; or 99.73 to 100.27.			

Function	Range	Resolution	Accuracy ¹
Pulse-Width	0.005 s	0.01ms	+(1.7% + 2 digits)
	0.01s		
	0.025 s		
	0.05 s		
	0.1 s	0.1ms	+(0.1% + 2 digits)
	0.25 s		
	0.5 s		
	2 s		
Rpm 2-cycle (inductive)	—	1 rpm	+(0.3% + 2 digits)
Rpm 4-cycle (inductive)	—	1 rpm	+(0.3% + 2 digits)
Secondary rpm	—	1 rpm	+(0.3% + 2 digits)
		10 rpm	
Volts AC RMS	0.1	0.1 mV	+(1.5% + 4 digits)
	0.2	0.001 V	
	0.5		
	1		
	2	0.01 V	
	5		
	10		
	20	0.1 V	
	50		
50			
Volts DC (Channel 1)	0.1	0.1 mV	+(1.0% + 2 digits)
	0.2	0.001 V	
	0.5		
	1		
	2	0.01 V	
	5		
	10		
	20	0.1 V	
	50		
	100		
	200		
	200		
¹ Accuracy, measured at 25°C, is shown as ± (% of reading) + (Number of least significant digits). For example, a 100V DC signal accuracy reading would be ± (0.25% + 2 digits), or 99.75 to 100.25 ± 2 digits; or 99.73 to 100.27.			

Function	Range	Resolution	Accuracy ¹
Volts DC (Channel 2)	0.1	0.1 mV	+(1.0% + 2 digits)
	0.2	0.1 mV	
	0.5	0.001 V	
	1	0.001 V	
	2	0.001 V	
	5	0.01 V	
	10	0.01 V	
	20	0.01 V	
	50	0.1 V	
	100		
200			
Volts DC Transducer inputs	—	0.0025 V	+(1.0% + 2 digits)
¹ Accuracy, measured at 25°C, is shown as ± (% of reading) + (Number of least significant digits).			
For example, a 100V DC signal accuracy reading would be ± (0.25% + 2 digits), or 99.75 to 100.25 ± 2 digits; or 99.73 to 100.27.			

2.5 Control Buttons

The Vantage PRO unit (Figure 2-2 on page 4) has the following control buttons:

- **Y/✓** button
- **N/X** button
- Thumb Pad (►, ◄, ▲, ▼)
- Brightness/Contrast button
- **S** button
- **Power** button

2.5.1 Y/✓ (Yes) Button

The Y/✓ button does the following:

- Selects the item you highlighted using the Thumb Pad.
- Toggles between cursors.

2.5.2 N/X (No) Button

The N/X button does the following:

- Exits a menu or program.
- Moves the highlight between the upper and lower parts of the screen.

2.5.3 Thumb Pad

The **Thumb Pad** (▶, ◀, ▲, ▼) moves the highlight around the screen for making menu or field selections and is typically used in combination with the **Y/✓** and **N/X** buttons.

2.5.4 Brightness/Contrast Button

The **Brightness/Contrast** button lets you adjust the screen for optimum viewing. See “Adjusting Brightness and Contrast” on page 20 for details.

2.5.5 S Button

The **S** button can be customized to perform different functions from the **Utilities > Tool Setup** menu. See “S Button” on page 91 for details.

2.5.6 Power Button

The **Power** button powers the Vantage PRO unit on and off. The option to put the unit in Standby mode is also available. See “Powering Off the Unit” on page 22 for details.

2.6 Connections

The Vantage PRO unit uses the following connections (Figure 2-3 on page 5):

- Test lead jacks
- DC power jack
- USB port

2.6.1 Test Lead Jacks

Standard safety banana jacks are used with test leads.

For related information, see the following sections:

- “Leads and Clips” on page 15
- “Connecting Leads and Clips” on page 21

2.6.2 DC Power Jack

The DC power jack can be used to power the unit with the AC/DC power adapter.

For related information, see the following sections:

- “AC/DC Power Adapter” on page 13
- “Connecting the AC/DC Power Adapter” on page 19

2.6.3 USB Port

The USB port can be used for connecting to a printer, keyboard or a PC.

For related information, see the following sections:

- “Setting Up to Print” on page 22
- “Editing Saved Files” on page 82

2.7 Power Sources

Your Vantage PRO unit can receive power from the following sources:

- AC/DC power adapter
- Battery pack (rechargeable)
- Vehicle power adapters (optional)

2.7.1 AC/DC Power Adapter

The Vantage PRO unit can be powered from a wall socket using the AC/DC power adapter (Figure 2-7).

When both the AC/DC power adapter and the battery pack are installed, the AC/DC power adapter is the primary power source.

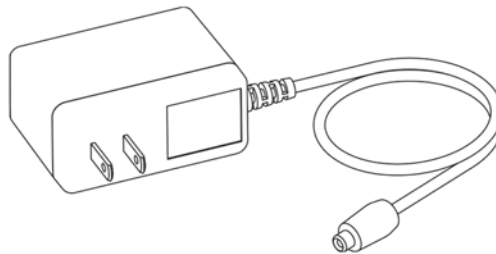

Figure 2-7 AC/DC power adapter



NOTE:

When connected to the Vantage PRO unit, the AC/DC power adapter will not charge an installed battery pack. See “Battery Charger” on page 14 for details.

2.7.2 Battery Pack

The Vantage PRO unit can be powered by a rechargeable nickel-metal hydride battery pack installed at the bottom of the unit behind the right handgrip (Figure 2-8).

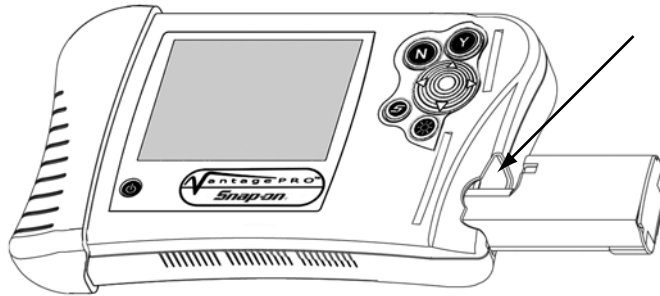

Figure 2-8 Battery pack installation location

2.7.3 Battery Charger

The battery pack is recharged by an external battery charger (Figure 2-9).

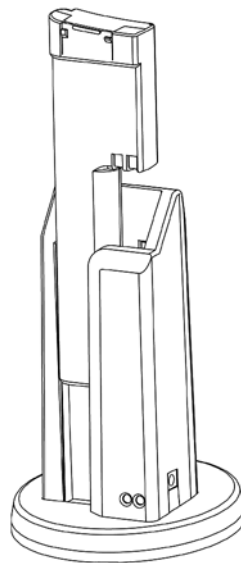

Figure 2-9 Battery charger

The Vantage PRO battery charger uses the same AC/DC power supply that can also be used to power the Vantage PRO unit. See “AC/DC Power Adapter” on page 13 for more details.

2.7.4 Vehicle Auxiliary Power Cables (Optional)

The Vantage PRO unit can be powered from a vehicle using the optional Lighter Power Cable and the optional Battery Power Cable (Figure 2-10).

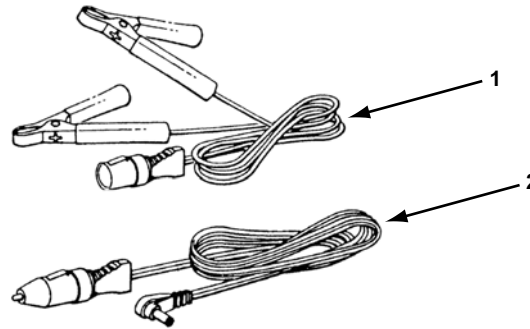

Figure 2-10 *Optional vehicle power adapters*

1— Battery Power Cable

2— Lighter Power Cable



NOTE:

If powering from a vehicle battery using the Battery Power Cable, the Lighter Power Cable is also required.

2.8 Leads and Clips

The Vantage PRO kit includes the following standard leads and clips:

- Channel 1 lead
- Channel 2 lead
- Alligator clips

IMPORTANT:

Pull on the connector, not the wire, to remove the leads from their jacks. Pulling on the wire can damage the leads.

See “Connecting Leads and Clips” on page 21 for more details.

2.8.1 Channel 1 Lead

The shielded yellow lead is used for Channel 1 (Figure 2-11). The lead color matches the color of the CH1 jack on the Vantage PRO unit and the trace color of **Ch 1** on the test screens. A stackable, black right-angle ground plug is attached.

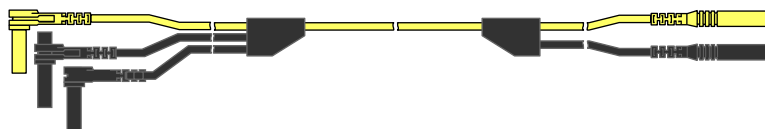

Figure 2-11 *Yellow Channel 1 Lead*

2.8.2 Channel 2 Lead

The shielded green lead is used for Channel 2 (Figure 2-12). The lead color matches the color of the CH2 jack on the Vantage PRO unit and the trace color of **Ch 2** on the test screens. A stackable, black right-angle ground plug is attached.

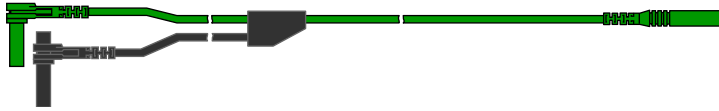

Figure 2-12 Green Channel 2 Lead

2.8.3 Alligator Clips

Three insulated alligator clips are included: one yellow and one green clip to match each test lead, and one black clip for the ground lead (Figure 2-13).

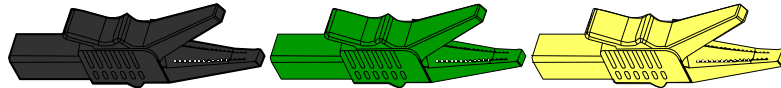

Figure 2-13 Alligator Clip

This section explains how to get started using your Vantage PRO unit. The following procedures are covered:

1. Supplying power to the Vantage PRO unit
2. Turning on the unit
3. Adjusting Brightness/Contrast
4. Connecting leads and adapters
5. Setting up to print (optional)
6. Turning off the unit

3.1 Supplying Power

There are several ways to supply power to the Vantage PRO unit:

- Using the Battery Pack
- Connecting the AC/DC Power Adapter
- Connecting Vehicle Auxiliary Power Cables

3.1.1 Using the Battery Pack

The Vantage PRO unit comes with a rechargeable nickel-metal hydride battery pack and an external battery charger.

For related information, see the following sections:

- “Battery Pack” on page 14
- “Battery Charger” on page 14
- “Replacing the Battery Pack” on page 97
- “Battery Pack Not Charging” on page 99

Before using the battery pack for the first time, you must fully charge it.



To charge the battery pack:

1. Plug the AC/DC power adapter into the DC power jack of the battery charger.



NOTE:

Do not put a hot battery pack in the battery charger unit. Allow the battery pack to cool first. For optimal battery charging, the ideal room temperature is 77°F (25°C) ±5°.

2. Vertically insert the battery pack into the charger (Figure 3-1).

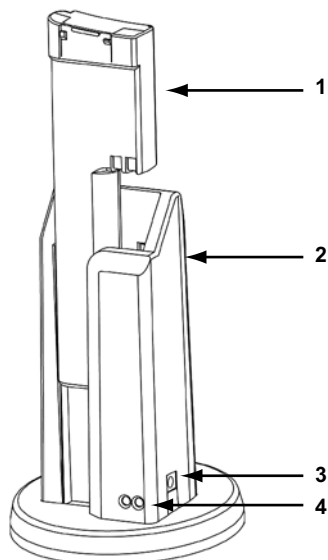

Figure 3-1 Battery pack charge orientation

- 1— Battery pack
- 2— Battery charger
- 3— DC power jack
- 4— Charge status lights

When charging begins, a red status light displays.

3. Let the battery pack charge until a steady green status light displays.
When the battery pack is too hot, too cold, or unable to hold a charge, both red and green charge status lights will flash. If the charge status lights flash for more than two hours, the battery pack may need replacing. See “Battery Pack Not Charging” on page 99.



NOTE:

A fully discharged battery pack takes four hours to charge.



To install the battery pack:

- Remove the right handgrip and insert the battery pack into the vacant battery slot (Figure 3-2).

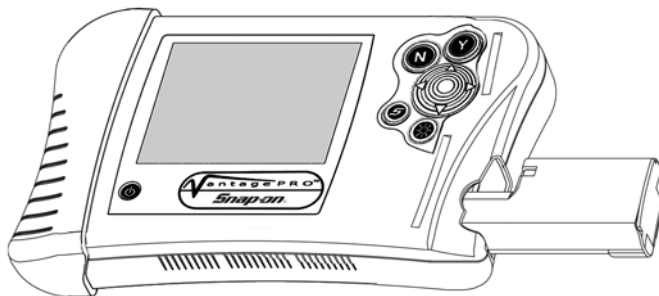

Figure 3-2 Battery pack slot



To extend the life of the battery pack:

- Before recharging the battery pack, let it become completely discharged.

A four minute warning will display before the battery pack becomes completely discharged (Figure 3-3).

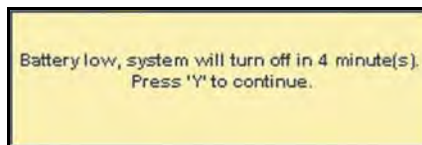

Figure 3-3 Sample low battery warning



To continue working after the battery warning displays:

- Choose and connect a AC/DC power adapter.

3.1.2 Connecting the AC/DC Power Adapter

The AC/DC power adapter (Figure 2-7 on page 13) provides power from a wall socket and is required to charge your battery pack.

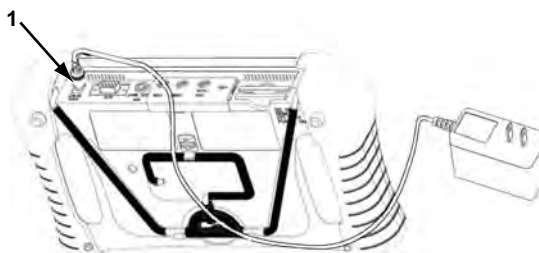

Figure 3-4 Sample AC/DC power supply connected

1— 2.5 mm plug



To connect the AC/DC power adapter:

1. Plug the 2.5 mm end of the AC/DC power adapter into the DC power jack on the top of your Vantage PRO unit (Figure 2-3 on page 5).
2. Plug the other end into an appropriate wall socket.
3. Press the Power button.

After the start up sequence is complete, the main menu screen displays.

3.1.3 Connecting Vehicle Auxiliary Power Cables

Optional vehicle auxiliary power cables can be used to provide power from the vehicle to your Vantage PRO unit.

For related information, see "Vehicle Auxiliary Power Cables (Optional)" on page 14.

**To connect the vehicle auxiliary power cables:**

1. Plug the 2.5 mm end of the Lighter Power Cable into the DC power jack on top of the Vantage PRO™ unit.
2. Plug the other end of the Lighter Power Cable into either the cigarette lighter or the Battery Power Cable receiver.
3. If the Battery Power Cable is used, clip the other ends of the Battery Power Cable to the positive and negative battery terminals of your test vehicle.

3.2 Powering On the Unit

When a master storage CF card is installed in slot 1 and power is supplied, you can power on the Vantage PRO™ unit.

For related information, see:

- “Supplying Power” on page 17
- “Powering Off the Unit” on page 22
- “Unit Will Not Power On” on page 99

**To power on the Vantage PRO unit:**

- Press and hold the **Power** button (Figure 2-2 on page 4) until the unit beeps. After a few seconds the main menu screen displays.

3.3 Adjusting Brightness and Contrast

The **Brightness/Contrast** button (Figure 2-2 on page 4) on the front of the unit adjusts the screen for optimum viewing.

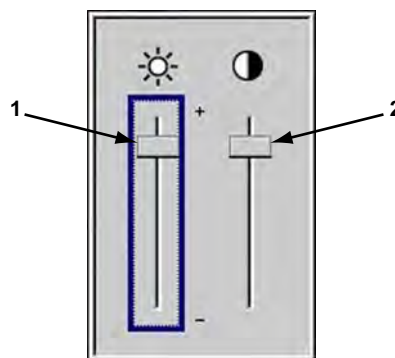

Figure 3-5 Set Brightness/Contrast dialog box

1— Brightness slide control

2— Contrast slide control

**To adjust brightness and contrast:**

1. Press the **Brightness/Contrast** button.
The Set Brightness/Contrast dialog box displays (Figure 3-5).
2. Select a slide control using the right ► or left ◀ arrows.
3. Press the up ▲ or down ▼ arrows to adjust brightness and contrast.
4. Press **N/X** to close the dialog box.

3.4 Connecting Leads and Clips

The Vantage PRO unit uses standard safety banana jacks. The following section explains how to connect the provided Vantage PRO unit leads and clips, as needed.

**NOTE:**

If you need to extend the length of a lead using a jumper wire, keep it as short as possible.

**To connect the Channel 1 lead:**

1. On the top of the Vantage PRO unit, plug the right-angled black ground plug into the jack labeled COM.
2. Plug the right-angled yellow connector into the jack labeled CH1.
3. Attach the yellow alligator clip to the yellow straight end of the lead and the black alligator clip to the black straight end of the lead.
4. Connect both of the alligator clip ends to the test vehicle, as needed.

**NOTE:**

Use the black stackable ground plug on the CH1 lead for grounding any other lead requiring a common ground.

**To connect the Channel 2 lead:**

1. Plug the black ground plug of the Channel 2 lead into the stackable ground plug of the Channel 1 lead.
This ground connection shields the Channel 2 lead.
2. Plug the right-angled green connector into the jack labeled CH2.
3. Attach the green alligator clip to the straight end of the Channel 2 lead.
4. Connect the alligator clip end to the test vehicle, as needed.

**To connect for internal amps tests:**

1. Plug the yellow connector into the blue jack labeled 10A, and plug the right-angled black ground plug into the jack labeled COM.
2. Attach the yellow alligator clip to the yellow straight end of the lead and the black alligator clip to the black straight end of the lead.
3. Connect the alligator clip ends to the test vehicle, as needed.

3.5 Setting Up to Print

Your Vantage PRO unit prints from USB-enabled PCL 3 or higher printers.

Before you can use the **Print** button in the upper toolbar, you must do the following:

1. Set up the printer.
2. Configure the Vantage PRO unit to print.



To set up the printer:

- Connect a USB cable between your Vantage PRO unit and your printer. See Figure 2-3 on page 5 for connection location.
- Refer to your printer's documentation for instructions on powering your printer and loading paper.



To configure the Vantage PRO unit to print:

- Select a printer manufacturer and port from the **Utilities > Tool Setup > Printer** dialog box. See "Printer" on page 90 for details.

3.6 Connecting to a Computer

Connecting your Vantage PRO unit to a computer for file sharing requires the use of the optional ShopStream Connect™ software. ShopStream Connect is a free software program that can be downloaded from the Internet at software.snapon.com.

3.7 Powering Off the Unit

The **Power** button (Figure 2-2 on page 4) on the front of the unit powers the Vantage PRO unit off or puts it in Standby mode. Standby mode conserves power while the unit is powered on but not in use.

For related information, see:

- "Power Management" on page 88
- "Emergency Restart" on page 99



To use the power options:

1. Press the **Power** button.
The **Turn off** Vantage PRO dialog box displays (Figure 3-6).



Figure 3-6 Turn off Vantage PRO dialog box

2. Select either **Standby** or **Turn off**, or press **N/X** to cancel.



To exit Standby mode:

- Press any button or the **Thumb Pad**.

This section describes basic screen layout and general Vantage PRO unit navigation.

4.1 Screen Layout

Vantage PRO screens include an upper toolbar, a main body, a lower toolbar and a status bar (Figure 4-1).

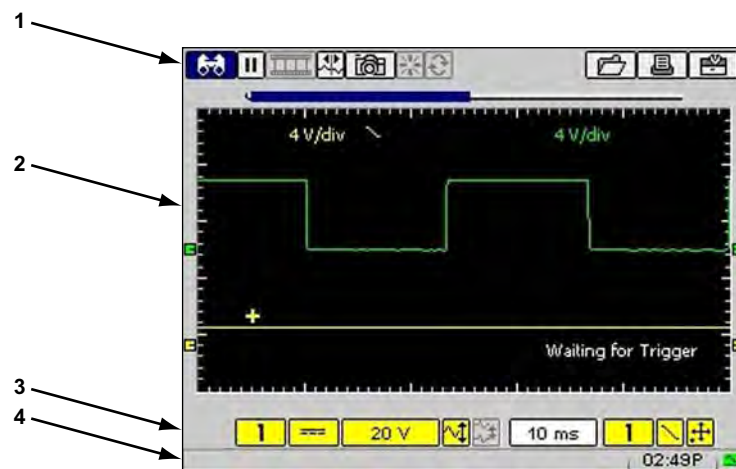

Figure 4-1 Sample Scope screen

1— Upper toolbar

Contains buttons that control various on-screen display and storage functions.

2— Main body

Displays menus and test data.

3— Lower toolbar

Contains buttons that control various test functions.

4— Status bar

Contains the test vehicle identification, the battery/power status and the time.

4.1.1 Upper Toolbar

The upper toolbar (Figure 4-2 and Figure 4-3) controls vary depending on the module and stage of operations (Table 4-1).



Figure 4-2 Sample "live-screen" upper toolbar



Figure 4-3 Sample "paused-screen" upper toolbar

Table 4-1 Upper toolbar controls

Name	Button	Description
View		Lets you change the way data displays
Pause		Stops data collection and lets you review data
Play		Captures data and stores it in the Data Buffer
Cursors		Lets you make measurements of test data
Review		Lets you review paused data
Snapshot		Lets you capture data before and after a problem occurs while testing
Zoom		Lets you change the magnification of paused data
Reset		Lets you clear the Min/Max values of digital gauges
Save		Lets you store data and settings
Print		Lets you print the selected screen information
Setup		Lets you change the way information appears and where it saves, and enter vehicle system information

Data Buffer

The Data Buffer (Figure 4-4) is located just below the upper toolbar buttons and indicates how much test data is stored.

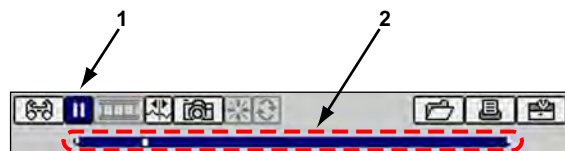

Figure 4-4 Sample Data Buffer

- 1— Pause button
- 2— Data Buffer

When the screen is paused, the position indicator displays the current frame number and the amount of data on the screen relative to the total data captured (Figure 4-5).

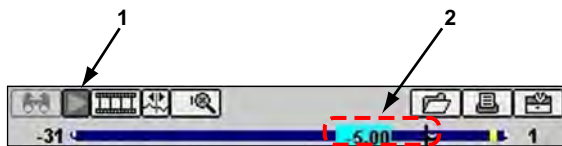

Figure 4-5 Sample paused screen with Position Indicator

- 1— Play button
- 2— Position Indicator

The Data Buffer cannot be highlighted or selected.



To manually scroll through stored frames:

1. When the screen is paused, select **Review**.
2. Press the left ◀ and right ▶ arrows.

4.1.2 Main Body

The main body of the test screens displays the following:

- Channel status information
- Digital or graphical test results
- Saved data
- Cursors
- Confirmation messages

4.1.3 Lower Toolbar

The lower toolbar controls (Figure 4-6, Table 4-2) vary depending on the active mode and stage of operation.









Figure 4-6 Sample lower toolbar

Table 4-2 Lower toolbar controls (part 1 of 2)

Name	Button	Description
Channel number		Lets you select the channel to adjust
Probe		Displays the current test connection for the channel
Scale		Displays the current units of measurement for the channel
Signal Zero Offset		Moves the selected channel's zero (0) position up or down within the test display area
Raster Spacing		Adjusts the vertical spacing between the cylinders in the Ignition Scope Raster pattern

Table 4-2 Lower toolbar controls (part 2 of 2)

Name	Button	Description
Sweep		Sets the amount of time displayed across the screen
Trigger Type		Sets the criteria used to start the display of data—there are three types of Trigger settings: None, Channel, and Cyl
Slope		Lets you change the Trigger edge for the specified channel from rising to falling
Trigger Position		Moves the trigger point for the specified channel—it can be moved up, down, left, or right
Calibration LED		Indicates channel calibration
Sensitivity Adjustment		Lets you adjust the ignition scope sensitivity.

**To navigate toolbars:**

- Press the left ◀ and right ▶ arrows to move between buttons.
- Press the up ▲ and down ▼ arrows or press the **N/X** button to move between the upper and lower toolbars.

When Easy Scroll is active, press the **N/X** button to move to the upper toolbar. Refer to “Easy Scroll” on page 94 for more information.

4.1.4 Status Bar

The status bar (Figure 4-1 on page 24) is located at the bottom of the screen. This non-selectable display area contains the test vehicle identification, battery/power status and time.

4.2 Making Selections

Use the following instructions to navigate the interface and make selections.

For related information, see “To navigate toolbars:” on page 27.

**To make selections:**

1. Highlight a button, menu option or window.
2. Press **Y/✓** to select.

**To navigate the main body of a screen:**

- Press the Thumb Pad arrows.

**To exit a selection**

- Press **N/X**.

4.2.1 Navigating Multi-Window Screens

The main body of the screens for both Component Tests and Component Information are divided into multiple windows (Figure 4-7).



NOTE:

Scroll arrows within a window indicate additional information is available that cannot fit on the screen. See “To view additional information:” on page 29 for additional information.

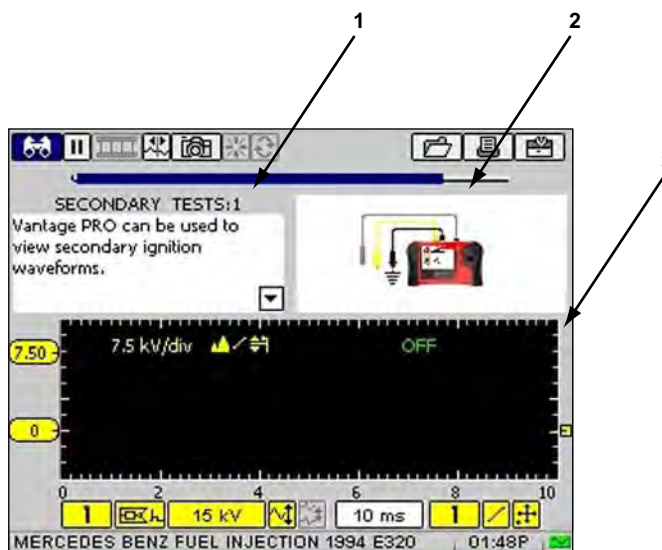

Figure 4-7 Sample Component Tests screen

- 1— Test Procedure window
- 2— Support window
- 3— Test Meter window



To select a window:

1. Use the down ▼ arrow to move from the upper toolbar.
2. Select a main body window.

When selected, the background and title text of the window change colors (Figure 4-8).

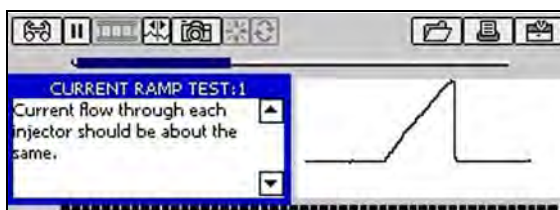

Figure 4-8 Sample selected main body test window



To deselect a window:

- Press **N/X**.

When deselected, the background and title text of the deselected window change colors.



To view additional information:

- Press the up ▲ or down ▼ arrow in the selected window (Figure 4-9) to display more information.

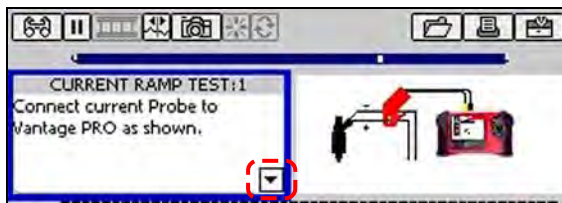

Figure 4-9 Down ▼ arrow indicating more information

When optional details or additional tests are available for the selected component test, a jump bar displays at the bottom of the Test Procedure window (Figure 4-10).



Figure 4-10 Sample jump bar



To display additional information using the jump bar:

1. Press the right ► arrow (Figure 4-10).
2. Follow the on-screen instructions in the jump bar to display all available information.
3. When you are finished, follow the on-screen instructions in the jump bar to return to the original screen (Figure 4-11).

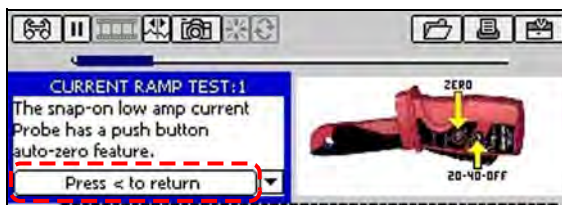

Figure 4-11 Sample jump bar return instruction

4.3 Easy Scroll

When active, the Easy Scroll utility simplifies the menu selection process. Instead of using the Thumb Pad to highlight an item and the **Y/✓** button to select it, Easy Scroll lets you use only the Thumb Pad to highlight and select an item.

Using Easy Scroll changes typical navigation in the following ways:

- The up ▲ and down ▼ arrows navigate menus.
- The right ► arrow works like the **Y/✓** button to confirm the selection of menu items.
- The left ◀ arrow works like the **N/X** button for cancelling, exiting, and closing menus.

The Easy Scroll utility functions differently depending on the module. For example, in modules that have upper and lower toolbars, the up ▲ arrow cannot be used to navigate to the upper toolbar. In this instance, use either **N/X** or the left ◀ and right ▶ arrows (in a figure-8 pattern) to move out of the lower toolbar.

Refer to “Easy Scroll” on page 94 for information on activating Easy Scroll.

4.4 Screen Messages

The Vantage PRO unit displays three types of messages:

- Confirmation Messages
- Warning Messages
- Error Messages



To manage on-screen messages:

- Follow the instructions included with the message.

4.4.1 Confirmation Messages

Confirmation messages inform you when you are about to perform an action that cannot be reversed or when an action has been initiated and your confirmation is needed to continue.

When a user response is not required, the message displays briefly before automatically disappearing.

4.4.2 Warning Messages

Warning messages inform you when completing the selected action may result in an irreversible change or loss of data.

4.4.3 Error Messages

Error messages inform you when a failure has occurred.

Example causes of possible errors include:

- when a cable is disconnected;
- when a printer is powered off.

This section describes features that are accessible from the Component Tests menu.

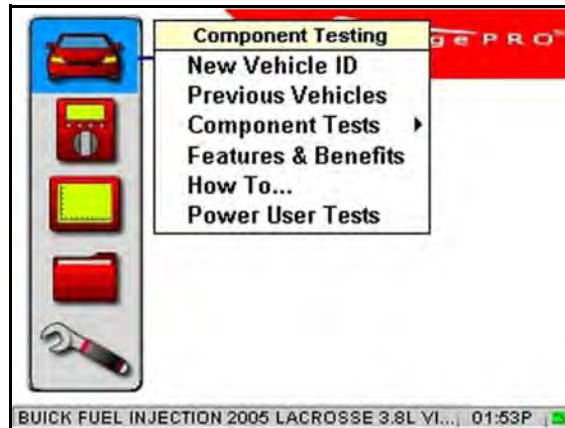

Figure 5-1 Sample Component Tests menu

The Component Tests menu (Figure 5-1) provides the following options:

- New Vehicle ID
- Previous Vehicles
- Component Tests
- Features and Benefits
- How To
- Power User Tests

5.1 Component Tests

The following is an outline of basic component testing operations.

1. **Identify the vehicle**—Identify the test vehicle or select from a list of previously-identified vehicles. See “Identifying the Test Vehicle” on page 32.
2. **Select a component test**—Select a vehicle-specific component for testing. See “Selecting a Component Test” on page 34.
3. **Connect to the vehicle**—Follow the on-screen instructions to connect the Vantage PRO unit to the vehicle. See “Connecting to a Test Vehicle” on page 35.
4. **Perform the test**—Follow the on-screen instructions to set up, test, and evaluate test results. See “Performing Tests” on page 35.

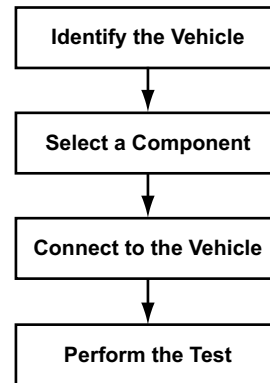

Figure 5-2 Basic Component Tests operations

5.2 Identifying the Test Vehicle

Component tests vary according to vehicle and system. Before you can view a list of available component tests, you must identify a specific vehicle system.

Two options are available for identifying a vehicle:

- New Vehicle ID
- Previous Vehicles

5.2.1 New Vehicle ID

The **New Vehicle ID** option requires that you make selections from a series of menus to identify the vehicle to be tested.



To identify a new test vehicle:

1. From the main menu, select **Component Tests > New Vehicle ID**.
The Region menu displays (Figure 5-3).



Figure 5-3 Sample Region menu

2. Select from the submenus as necessary.
If you need to change a selection, press the left ◀ arrow to go back one step at a time.



NOTE:

As you make selections, vehicle identification data displays in the Status bar (Figure 5-4) at the bottom of the screen.

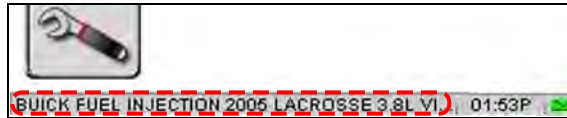

Figure 5-4 Sample Vehicle Identification data

When you have finished identifying the vehicle, a confirmation message displays (Figure 5-5).

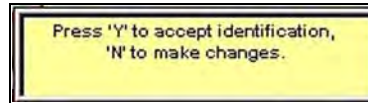

Figure 5-5 Sample Vehicle ID confirmation message

3. To proceed, select a component test.



To exit New Vehicle ID:

- Press **N/X** anytime during the ID process to return to the previous menu.
- Continue pressing **N/X** until you return to the main menu.

5.2.2 Previous Vehicles

When testing a vehicle that has already been identified, the **Previous Vehicles** menu option provides access to the Load Vehicle Identification screen (Figure 5-6). The Vantage PRO unit automatically saves the last ten vehicle identifications and lists them on this screen.



To load a previously-identified vehicle:

1. Select **Component Tests > Previous Vehicles**.

The Load Vehicle Identification screen displays (Figure 5-6).

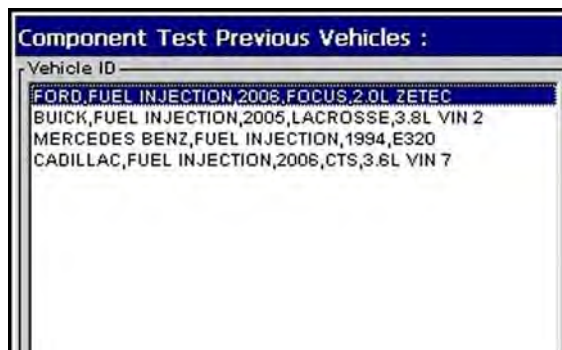

Figure 5-6 Sample Load Vehicle Identification screen

2. Select a vehicle from the list.



To exit the Load Vehicle Identification screen:

- Press **N/X** to return to the main menu and keep the current vehicle identification setting.

5.3 Selecting a Component Test

Once a test vehicle is identified, you can select from the Component Tests menu.

The main body (Figure 5-10) of the test screen can contain the following sections:

- **Test Procedure window**—contains connection and testing procedures.
- **Support window**—contains support information, such as connector illustrations.
- **Test Meter window**—functions as a Graphing Meter, Digital Meter, or Lab Scope, depending on the selected test.



To select a component test:

1. Select **Component Tests > Component Tests**.

The Component Tests menu displays the available components for the identified test vehicle (Figure 5-7).

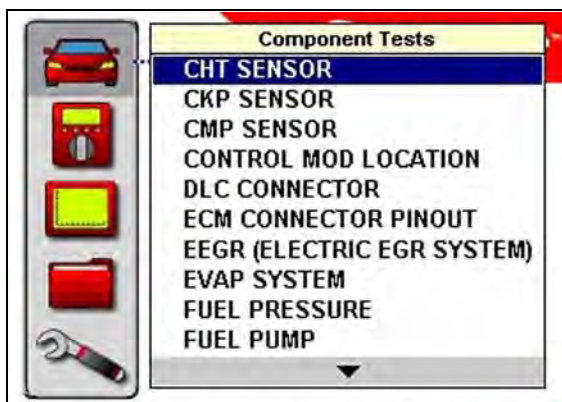

Figure 5-7 Sample Component Tests menu

2. Select a component.

The component menu displays (Figure 5-8).

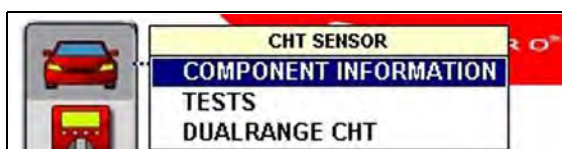

Figure 5-8 Sample component menu

3. Select **TESTS**.

A Tests menu displays (Figure 5-9).



Figure 5-9 Sample TESTS menu

4. Select a test.

The Test screen displays (Figure 5-10).



Figure 5-10 Sample Component Tests screen

5.4 Connecting to a Test Vehicle

Certain component tests require the use of specific leads that connect your Vantage PRO unit to a test vehicle.

The initial test screen displays connection information.



To connect to a test vehicle:

- Follow the on-screen connection instructions located in the Test Procedure and Support windows (Figure 5-11).



Figure 5-11 Sample connection instructions

5.5 Performing Tests

When you have connected the Vantage PRO unit to the test vehicle, you can proceed with component tests.



To perform component tests:

1. Select the Test Procedure window.
2. Use the Thumb Pad to read all setup instructions.

Instructions display in the Text Procedure window, accompanied by illustrations in the Support window (Figure 5-12).

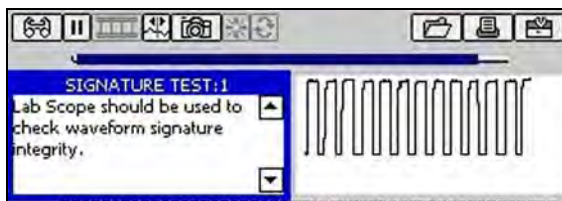

Figure 5-12 Sample setup instructions

3. Press the down ▼ arrow to advance to the next panel of instruction as needed.
4. Follow the on-screen procedures as needed.
5. View and verify the test results as explained on-screen (Figure 5-13).

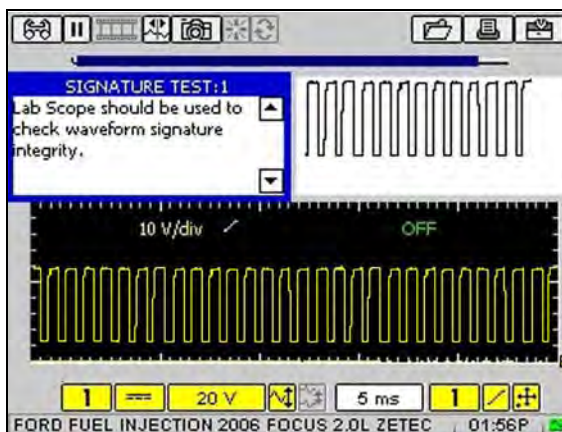

Figure 5-13 Sample test results

5.5.1 Changing Views

The **View** button lets you change the way data displays.



To change screen views:

1. Select **View**.
The dropdown menu displays (Figure 5-14).

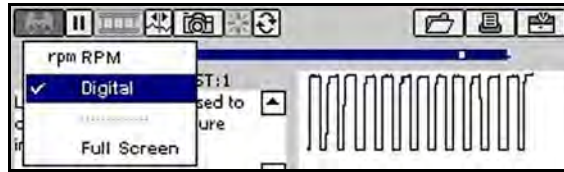

Figure 5-14 Sample View menu

2. Select a viewing option.
The screen changes to reflect your selection (Figure 5-15).

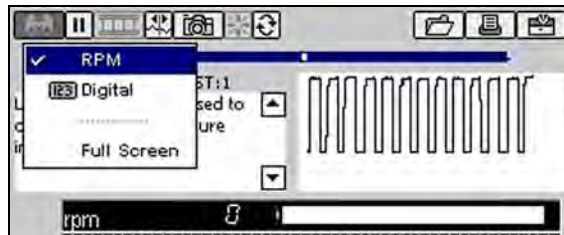

Figure 5-15 Sample RPM display

5.5.2 Pausing Data

The **Pause** button (Figure 5-16) stops data collection and lets you review data. The screen can be paused at any time.

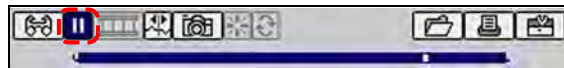

Figure 5-16 Sample Pause button



To pause test screen data:

1. Select **Pause**.
Data is motionless on-screen and some upper toolbar button functions change (Figure 5-17):
 - The **Play** button replaces the **Pause** button.
 - The **Review** button is selectable.
 - The **Zoom** button replaces the **Snapshot** button.
 - The Position Indicator displays in the Data Buffer.

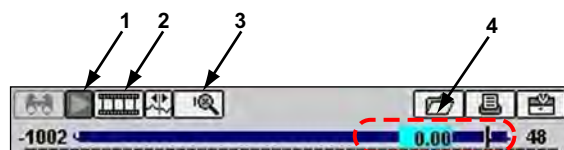

Figure 5-17 Sample "paused" upper toolbar

- 1— Play button
- 2— Review button
- 3— Zoom button
- 4— Position Indicator



To release paused test data:

- Select **Play**.
The data is moving on-screen and toolbar controls return to their original functions.

5.5.3 Reviewing Data

The **Review** button is used with the Thumb Pad to review paused data.

The Position Indicator (Figure 5-17) displays the position of the current frame.

- Zero denotes the frame when Pause was pressed.
- Frames captured before Pause was pressed are negative (-).
- Frames captured after are positive (+).

There are two ways to review paused data:

- Manually
- Automatically



To manually review data:

1. Select **Pause**.
2. Select **Review**.
3. Use the right ► and left ◀ arrows to review data one frame at a time.
4. Use the up ▲ and down ▼ arrows to review data a fraction of a frame at a time when possible.



NOTE:

You cannot review fractions of frames in the Ignition Scope.



To automatically scroll paused data:

1. With the **Review** button selected, press **Y/✓** again to display the menu of scroll options (Figure 5-18).



Figure 5-18 Sample Review scroll menu

2. From the **Review** menu, select an **Auto** option.
 - Auto Scroll Fast automatically scrolls the paused data on-screen at full-speed.
 - Auto Scroll Slow automatically scrolls the paused data on-screen at half-speed.
3. Press **N/X** to close the menu and stop automatic scrolling.

5.5.4 Using Zoom

The **Zoom** button lets you change the magnification of paused data and appears in place of the **Snapshot** button when the display is paused.



To zoom paused test screens:

1. Select **Zoom**.
A dropdown menu displays (Figure 5-19).

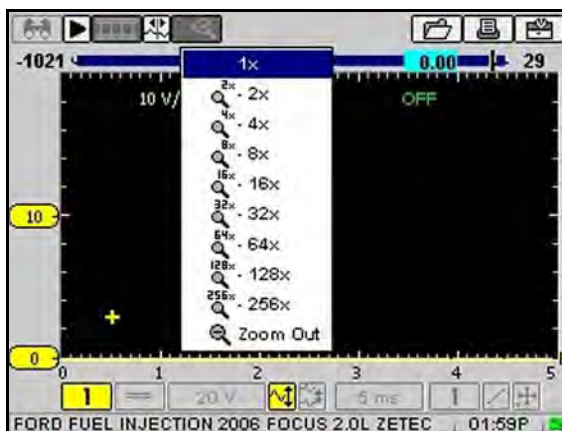

Figure 5-19 Sample Zoom option selection

2. Select an option from the menu.
The screen changes to reflect your selection and the on-screen Zoom Cursor Line displays (Figure 5-20).

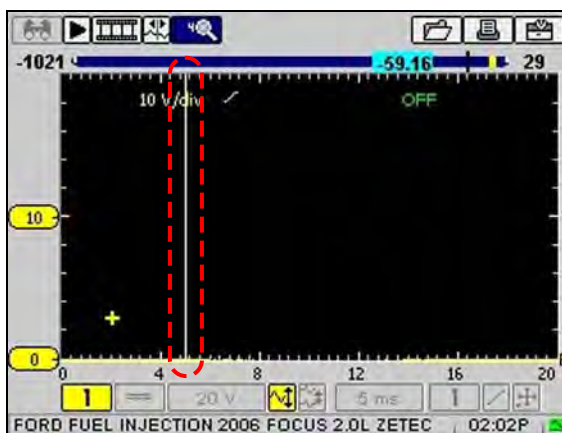

Figure 5-20 Sample Zoom Cursor Line

3. To see a point of interest in detail:
 - a. Select **Review**.
 - b. Use the left ◀ and right ▶ arrows move the Zoom Cursor Line to the left of the point of interest.
 - c. Select **Zoom > 1x**.

5.5.5 Using Cursors

The **Cursors** button (Figure 5-21) lets you make digital amplitude, frequency, and time measurements of test data.



Figure 5-21 Cursors button

**To use cursors:**

1. Select **Cursors**.

Two vertical cursor lines display on-screen (Figure 5-22).



Figure 5-22 Cursors example screen

2. Press the right ► and left ◀ arrows to move the selected cursor line.
3. Press **Y/✓** to change the active cursor.
4. Press **N/X** when you are finished setting cursors.

A confirmation message asks how you want to proceed (Figure 5-23).

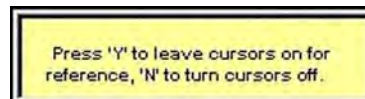

Figure 5-23 Sample Cursors confirmation message

5. Press **Y/✓** or **N/X** as desired.

**NOTE:**

Digital amplitude measurements only display when the screen is in Pause mode.

**To turn cursors off:**

1. Select **Cursors**.
2. Press **Y/✓** twice.

The cursor lines disappear.

5.5.6 Taking Snapshots

The **Snapshot** button lets you capture data before and after a problem occurs while testing.



To take a snapshot:

1. Select **Snapshot**.
A dropdown menu displays (Figure 5-24).



Figure 5-24 Sample Snapshot menu

2. Select **Manual**.
The flash icon blinks (Figure 5-25), indicating that Manual Snapshot mode is ready for use.

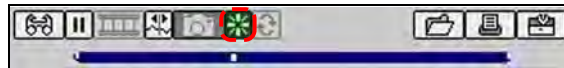

Figure 5-25 Sample Snapshot flash icon

3. Press **Y/✓** to take a snapshot.
The Collecting Snapshot message displays, indicating that Snapshot data is being collected (Figure 5-26).



Figure 5-26 Sample Collecting Snapshot confirmation message

When the Snapshot finishes saving, a final confirmation message displays (Figure 5-27).

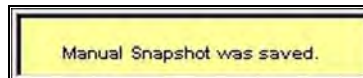

Figure 5-27 Snapshot saved confirmation message

When the confirmation message disappears, you return to the test screen ready to take another snapshot.

4. Stop using the snapshot by pressing **N/X**.



NOTE:

The saved snapshot can be retrieved from Saved Data. Refer to “Loading Saved Files” on page 81 for details.

Changing Snapshot Settings

You can set up a snapshot in the following ways:

- **Adjust the percentage after trigger**—snapshots can be between 10% and 90% data captured after triggering.
- **Save to different locations**—snapshots can be saved to CF1, CF2, or the USB port.

- **Choose the file type**—select between bitmap and jpeg format for saving images.



To change Snapshot settings:

1. From the Vantage PRO main menu, select **Utilities > Tool Setup > Save Data**.
The Save Data dialog box displays (Figure 5-28).

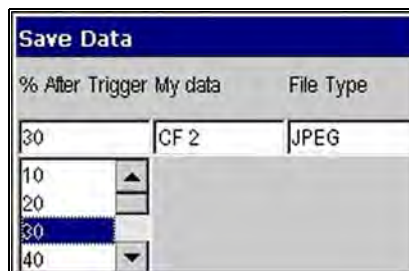

Figure 5-28 Sample Save Data dialog box

2. Select the **% After Trigger** to open the dropdown menu.
3. Select a % After Trigger setting.
4. Select **My Data** to open the dropdown menu.
5. Select a location to save the data to.
6. Select **File Type** to open the dropdown menu.
7. Select a file type.
8. Press **N/X** to close the dialog box.

5.5.7 Resetting Gauges

The **Reset** button (Figure 5-29) returns the recorded digital gauge min/max values to zero.



Figure 5-29 Sample Reset button

Use the Reset button to do the following:

- Track the variation in a component or circuit under a certain condition. If the condition changes, Reset lets you start tracking again to see the change.
- Verify a connection problem you found has been fixed by looking for a dropout or a spike in the min/max values.



To reset the min/max digital values:

- Select **Reset**.

A confirmation message displays (Figure 5-30).

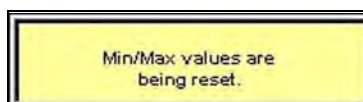

Figure 5-30 Sample Reset confirmation message

When the reset is complete, the confirmation message disappears.

5.5.8 Saving Data

The **Save** button lets you store data and presets in memory. For more information on presets, see “Using Presets” on page 74.



To save data:

1. Select **Save**.
A dropdown menu displays (Figure 5-31).



Figure 5-31 Sample Scope Save menu

2. Select an option from the menu:
 - **Save Movie**—saves all data in the buffer.
 - **Save Frame**—saves only the visible screen data.
 - **Save Preset**—saves only Scope screen configurations used for future testing. See “Using Presets” on page 74 for more details.
 - **Save Image**—saves the visible screen as a graphic image.

The Setup Saved Data Notation dialog box displays for screen saving (Figure 5-32).

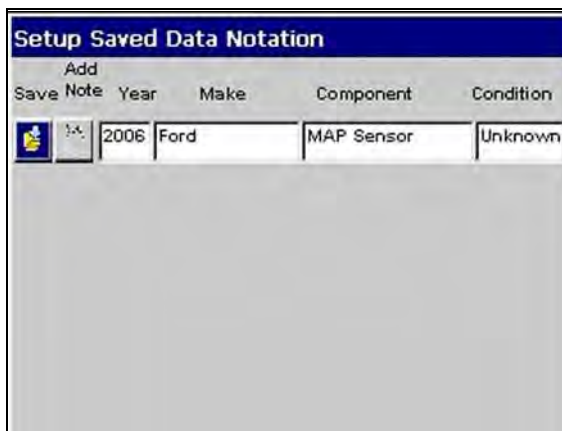

Figure 5-32 Sample Setup Saved Data Notation dialog box

3. Select from the menus to set preferences as necessary.
The Setup Saved Data Notation dialog box works the same as the Edit Saved Data Notation dialog box found in the Saved Data mode. See “Editing Saved Files” on page 82 for details.
4. When you are finished setting preferences, select the **Save** icon.
A confirmation message displays with saved data retrieval instructions (Figure 5-33).



Figure 5-33 Sample Data saved confirmation message

5. Press **Y/✓** to close the confirmation message.

5.5.9 Printing

The **Print** button lets you print the displayed screen.



To print:

1. Select **Print**.
A dropdown menu displays (Figure 5-34).



Figure 5-34 Sample Print menu

2. Select a menu option and press **Y/✓**.
The screen prints according to your printer settings. See “Setting Up to Print” on page 22.

5.5.10 Using Setup

The **Setup** button (Figure 5-35) lets you change the way information displays.

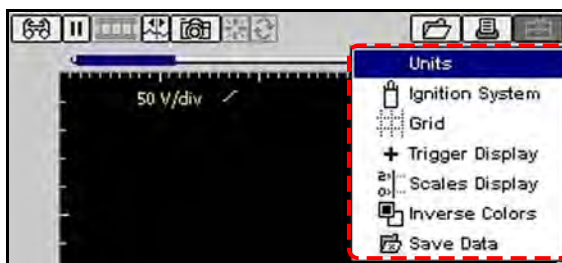

Figure 5-35 Sample Setup button menu



To use Setup:

1. Select the **Setup** button.
A dropdown menu displays.
2. Select one of the possible options, which are explained in the following sections.

5.5.11 Units

Select **Units** to change the units of measurement for vacuum and pressure (Figure 5-36).

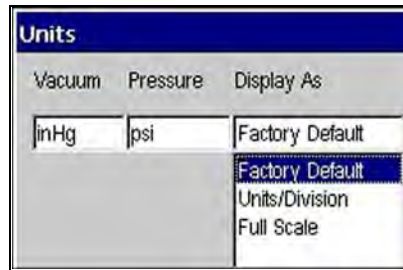

Figure 5-36 Sample Units dialog box

The **Display As** dropdown menu sets how the scale units are displayed on the Scale button and in the Channel Status area (Figure 5-37).

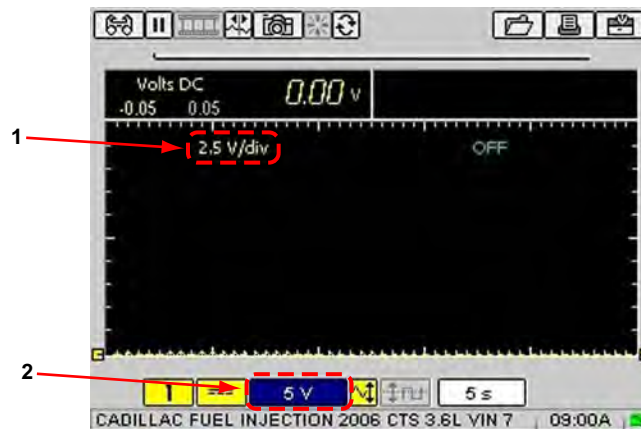

Figure 5-37 Setup, Units, Factory Default sample screen

1— Channel Status area

Displays the scale settings for all channels.

2— Scale button

Displays the scale setting for the currently selected channel.

There are three Display As scale unit options:

- **Factory Default**—the Channel Status area displays the Units/Division for all active channels and the Scale button displays the full scale value (Figure 5-37).
- **Units/Division**—the scale value for a major grid division is displayed in the Channel Status Area and the Scale button (Figure 5-38).
- **Full Scale**—the scale value for the whole grid is displayed in the Channel Status Area and the Scale button (Figure 5-39).

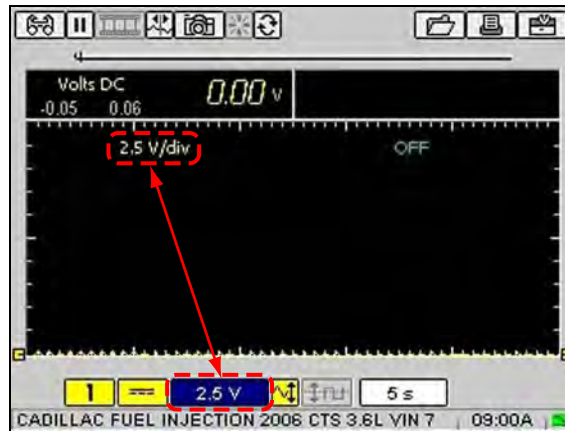

Figure 5-38 Sample Units/Division selection

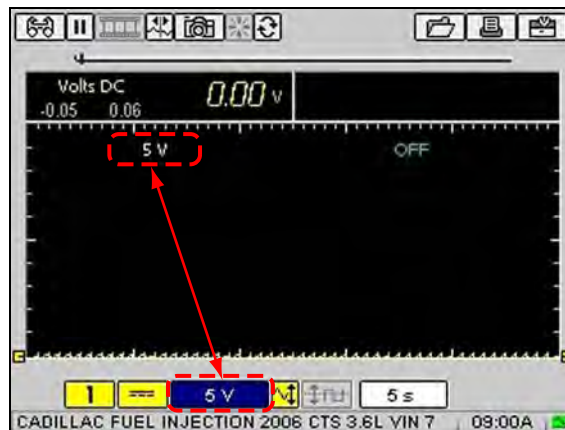

Figure 5-39 Sample Full Scale selected



NOTE:

The Units dialog box can also be accessed from the Utilities menu located on the Tool Setup submenu as described in “Units” on page 87.



To change units:

1. Select **Setup > Units**.
The Units dialog box displays (Figure 5-36 on page 45).
2. Change the unit values as needed.
3. Press **N/X** to close the dialog box.

Ignition System

Before ignition testing can begin, the ignition system type and any relevant parameters should be selected.

Selecting **Ignition System** displays the Ignition System dialog box (Figure 5-40) that lets you select the following for the test vehicle:

- Ignition type

- Number of cylinders
- Cylinder firing order
- #1 Trigger (Inductive RPM Pickup connection)
- Cylinder firing polarity
- RPM factor

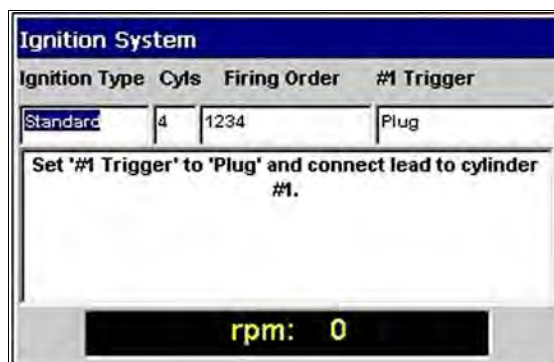

Figure 5-40 Sample Ignition System dialog box

The following ignition types and settings are available:

- **Standard**—The Inductive RPM Pickup connects to the coil or plug wire on a distributor system. Set the number of cylinders and cylinder firing order. (Figure 5-40 on page 47).
- **Waste Spark**—The Inductive RPM Pickup connects to a plug wire on a waste spark distributorless system. Set the number of cylinders, cylinder firing order, and polarity.

IMPORTANT:

Be sure the firing order and cylinder firing polarity values are correctly set up before using the Ignition Scope to test Waste Spark systems.

- **Direct**—The Inductive RPM Pickup connects to a plug wire (if applicable) on a direct ignition system. Set the number of cylinders and cylinder firing order.
- **Other**—The Inductive RPM Pickup connects to a plug or a coil wire. Set the RPM factor appropriate for the test vehicle.

NOTE:



The Ignition System dialog box can also be accessed from the Utilities Tool Setup menu. Refer to “Ignition System” on page 88 for details.



To change Ignition System settings:

1. Select **Setup > Ignition System**.
The Ignition System dialog box displays (Figure 5-40).
2. Select the Ignition System values as needed.
3. Press **N/X** to close the dialog box.

Grid

Select **Grid** to display the background grid pattern on all graphing test screens.

**To turn the grid on:**

- Select **Setup > Grid**.
A grid appears in the test area (Figure 5-41).

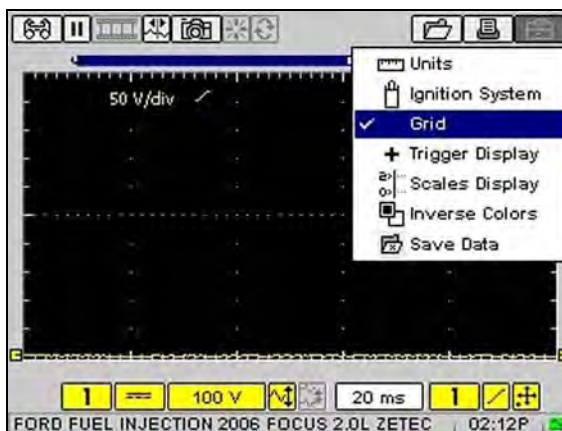

Figure 5-41 Grid sample screen

Trigger Display

Select **Trigger Display** to turn on the Trigger position values (Figure 5-42).



Figure 5-42 Sample Trigger values

When Trigger Display is not selected, trigger position values only display when the trigger position button is selected on the lower toolbar.

**To display trigger values:**

- Select **Setup > Trigger Display**.
The Trigger values display (Figure 5-42).

Scales Display

Select **Scales Display** to display the scale values on the graph.



To turn Scales Display on:

- Select **Setup > Scales Display**.

The scale values appear along the X (horizontal) and Y (vertical) axis of the graph (Figure 5-43).

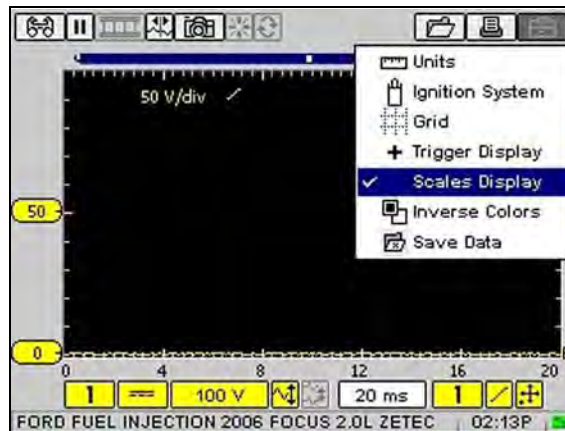

Figure 5-43 Scales Display sample screen

Inverse Colors

Select **Inverse Colors** to change the color scheme.



To change the color scheme:

- Select **Setup > Inverse Colors**.

The color scheme changes (Figure 5-44).

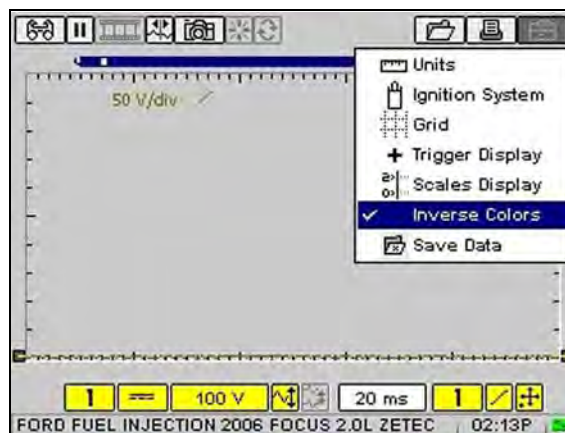

Figure 5-44 Sample Inverse Colors screen

Save Data

This selection opens the Save Data dialog box (Figure 5-28), which lets you choose how and where files are saved.

5.5.12 Calibration LED

When you select a Diodes, Continuity, Ohms or Pressure transducers test, a message displays with calibration instructions (Figure 5-45).

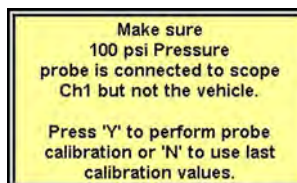

Figure 5-45 Sample calibration procedure message

When the test screen displays, the LED (Figure 5-46) on the toolbar indicates the following channel calibration status:

- **Green**—calibrated
- **Red**—not calibrated (using previous calibration values)

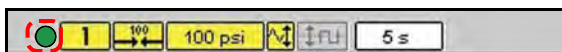

Figure 5-46 Sample calibration LED

5.5.13 Adjusting Channel Settings

The Channel control bar (Figure 5-47) lets you adjust channel settings and viewing characteristics for the selected trace.

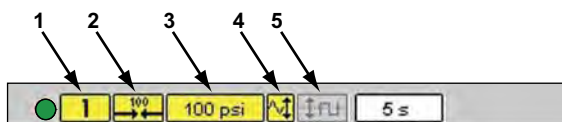

Figure 5-47 Sample Channel control bar

- 1— Channel Number
- 2— Probe
- 3— Scale
- 4— Signal Zero Offset
- 5— Raster Spacing (Ignition Scope Only)

Channel Number

The **Channel Number** button lets you select channel options.

- Channel One (**1**) is automatically displayed and cannot be turned off.
- Channel Two (**2**) can be manually selected for display.



NOTE:

Both channels automatically display in the 2 ch Graphing Meter mode.

The following channel options are available:

- **Displayed**—makes a channel's signal visible.
- **Inverted**—flips the selected waveform upside-down. This is typically used when testing secondary ignition or displaying waveforms from the Low Amps Probe.
- **Coupling AC**—subtracts the average value of a waveform to see small variations, which is ideal for viewing alternator ripple or fuel pump amps. This blocks the DC portions of an input signal to amplify the AC portions without driving them off the center of the screen.
- **Peak Detect**—captures fast events, spikes and glitches for signals going in positive and negative directions.
- **Filter**—minimizes unwanted noise.
- **Auto Find**—picks the best scale to fit the selected signal pattern on the screen. If run on the same channel as the trigger, the trigger level is set halfway between the minimum and maximum values of the waveform.



NOTE:

When testing with the Single Cylinder Ignition scope, the Channel 1 Peak Detect option cannot be turned off.



To display Channel Two:

1. Select **Channel Number**.

The channel setup menu displays (Figure 5-48).

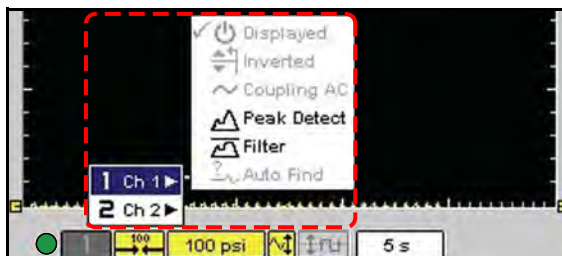

Figure 5-48 Sample Channel 1 setup menu

2. Select **Ch 2 > Displayed**.

The Channel Two trace displays (Figure 5-49).

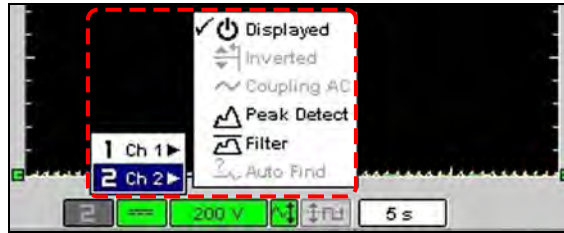

Figure 5-49 Sample with Channel 2 displayed

3. Press **N/X** to close the menu.



To change the channel setup:

1. Select **Channel Number**.
The channel setup menu displays (Figure 5-48).
2. Select the channel you want to change (**Ch 1** or **Ch 2**).
3. Select the **Peak Detect** or **Filter** channel setup option.

Probe

The **Probe** button (Figure 5-50) lets you select a different test.

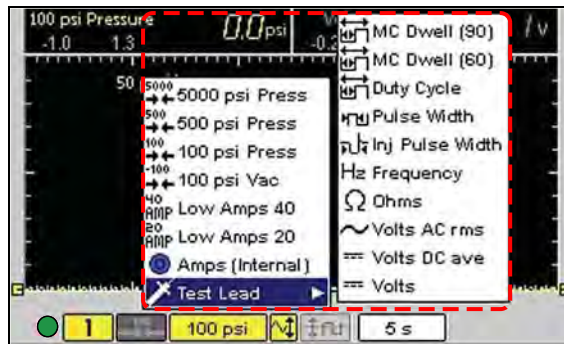

Figure 5-50 Sample Probe button and menu



To select a different test:

1. Select the **Probe** button.
The Probe menu displays (Figure 5-50).
2. Select an option.
The **Probe** button changes to indicate your selection.

Scale

The **Scale** (Figure 5-51) button lets you select a measurement scale for each channel.

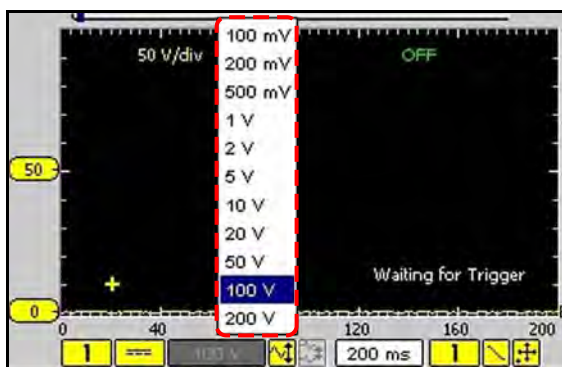

Figure 5-51 Sample Scale button and menu



To select a measurement scale:

1. Select **Scale**.
The Scale menu displays (Figure 5-51).
2. Select an option.
The **Scale** button and the waveforms on-screen change to reflect your selection.

Signal Zero Offset

The **Signal Zero Offset** button moves the selected channel's zero (0) position up or down within the test display area.



To move a channel's zero position:

1. Select **Signal Zero Offset**.
The button changes from blue to grey to indicate that the function is selected (Figure 5-52).



Figure 5-52 Sample Signal Zero Offset selection

2. Press the up ▲ or down ▼ arrows as needed to move the zero point.
3. Press **N/X** to exit the function.

Threshold

The **Threshold** button changes the reference point on the waveform and is only used for calculating measurements like frequency, duty cycle, MC dwell and pulse width.

There are two threshold options:

- **Auto Threshold Select (ATS)**—automatically picks a threshold level in the middle of the range in which the waveform travels. ATS defaults to a falling edge.
- **Manual Threshold Select (MTS)**—lets you manually pick a signal level and direction (rising or falling) to be used as a reference point. This is typically used if ATS picks a level that does not give the desired result.



To change the threshold level:

1. Select **Threshold**.
The Threshold menu displays (Figure 5-53).



Figure 5-53 Threshold menu sample

2. Select an option.



To use the Manual Threshold option:

1. Select **Threshold > Manual Threshold Select**.
The Manual Threshold Select dialog box displays (Figure 5-54).



Figure 5-54 Sample Manual Threshold Select dialog box

The Signal Min and Max display to the left and right of the Threshold value for reference. Measuring the Min and Max may take a few seconds.

2. Change the Threshold value and the Slope, as needed.



NOTE:

Threshold can only be changed to a value that is between the Min and Max of the signal.

3. Press **N/X** to exit the dialog box.

5.5.14 Setting the Sweep Time

The **Sweep** button sets the amount of time it takes for data to display across the screen from left to right.



To change the sweep time:

1. Select **Sweep**.
The dropdown menu displays (Figure 5-55).

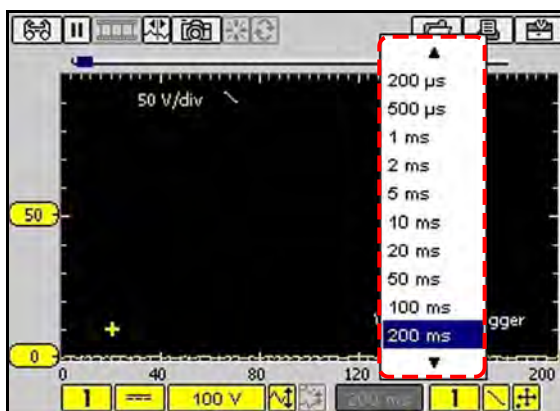

Figure 5-55 Sample Sweep menu

2. Select an option.

**NOTE:**

Sweeps shorter than 1 second will collect some frames after the Pause button is selected. The faster the sweep, the more frames will be collected.

5.5.15 Setting the Trigger

Use the Trigger control bar (Figure 5-56) to set the criteria to start the display of data.

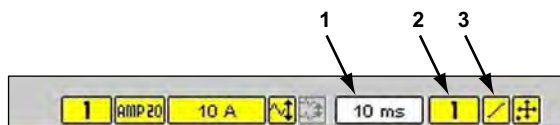

Figure 5-56 Sample Trigger control bar

- 1— Sweep
- 2— Channel
- 3— Slope

Trigger Type

Selecting **Trigger Type** lets you set the criteria used to start the display of data. Available Trigger Type menu options include:

- **None**—displays data as fast as it is received.
- **Ch 1/2**—triggers the display based on the signal from the selected channel. Available submenu options include:
 - **Auto**—updates the screen when the signal crosses the trigger threshold in the selected direction (rising or falling).
 - Even if the signal does not cross the trigger threshold, the screen automatically updates after a short period so you can see the waveform, which lets you set a threshold to optimize viewing.

- **Normal**—updates the screen when the signal crosses the trigger threshold in the selected direction (rising or falling).
- If the signal does not cross the trigger threshold, the screen will not update which lets you capture intermittent events because the screen only updates when the signal meets your trigger selection.
- **Cyl**—triggers the scope from the RPM lead signal. The lead detects the firing on the plug wire that the lead is connected to and the scope uses this signal to trigger the display. You can only adjust the time offset for this Trigger-type.
 - **Auto**—updates the screen when the scope receives a signal from the RPM lead.
 - Even if the signal does not receive a signal from the lead, the screen automatically updates after a short period so you can still see the waveform.
 - **Normal**—updates the screen when scope receives a signal from the RPM lead.
 - If the scope does not receive a signal from the lead, the screen will not update.



To select a trigger type:

1. Select the **Trigger Type** button.
The dropdown menu displays (Figure 5-57).

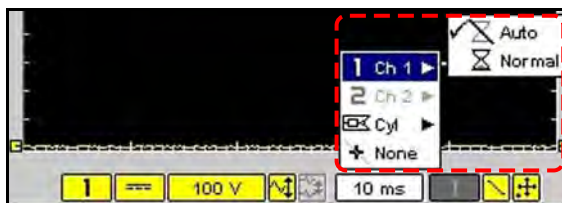

Figure 5-57 Sample Trigger Type menu

2. Select an option.
With the exception of **None**, a submenu displays.
3. Select **Auto** or **Normal** from the submenu.
 - If a Channel trigger (Ch1–2) is selected, a plus sign (+) colored according to the channel it represents displays in the graph area (Figure 5-58).
 - If the Cyl trigger is selected, a white plus sign (+) displays along the bottom of the graph area which represents the point in time a cylinder is detected on the RPM lead (Figure 5-59).

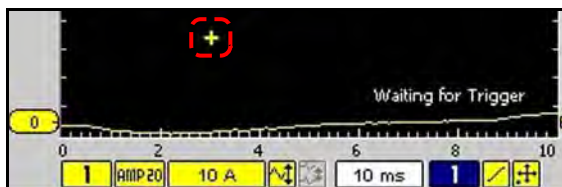

Figure 5-58 Sample Trigger Position marker



Figure 5-59 Sample Cyl Trigger Position marker

- When you are finished setting the trigger modes, press **N/X** to close the menu.

Trigger Slope

The **Trigger Slope** button (Figure 5-60) selects the direction the waveform must be going (rising or falling) when crossing the trigger point.



Figure 5-60 Sample Trigger Slope button



NOTE:

This button is only available when a **Channel** is the active trigger type.

5.5.16 Trigger Position

The **Trigger Position** (Figure 5-61) button is used for moving the trigger point for a specified channel either along the X (horizontal) or Y (vertical) axis of the display.

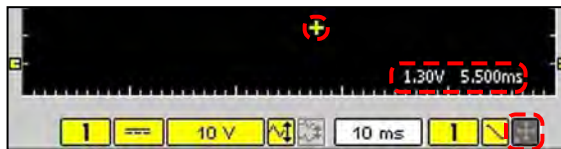

Figure 5-61 Sample Trigger Position button



To move the trigger point:

- Select **Trigger Position**.
The trigger point marker becomes active.
- Use the Thumb Pad to move the on-screen marker and select a new trigger point.
- When you are finished, press **N/X**.

5.6 Viewing Component Information

This section explains how to view component information. The following is an outline of basic testing operations.

1. **Identify the vehicle**—Identify the test vehicle to the Component Tests module or select from a list of previously identified vehicles.
2. **View component information**—Display up to four categories of vehicle-specific component information. See “Viewing Component Information” on page 57 for details.

5.6.1 Identifying the Vehicle

The vehicle identification process is the same as for vehicle testing. See “Identifying the Test Vehicle” on page 32 for information.

5.6.2 Viewing Component Information

Once the test vehicle is identified, you can select the Component Tests function from the Component Tests menu.

The main body of the Component Information screen (Figure 5-62) can contain one or more of the following sections:

- **Operation**—gives you a general description of normal component operation.
- **Connector**—displays the component connector and gives you pinouts and wire color information.
- **Location**—helps you locate the component and tells you where to test it.
- **Technotes**—gives you component test-related tips (for example, common failures or faults) as well as update or recall information.

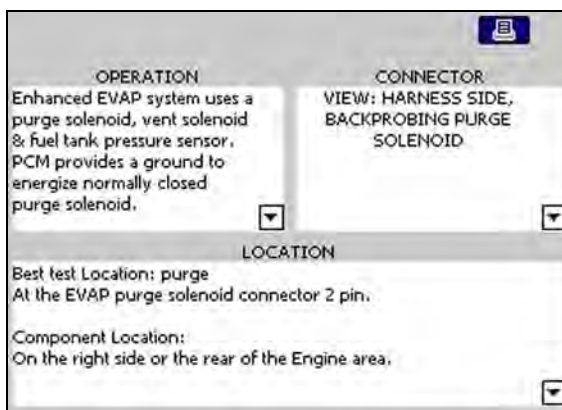

Figure 5-62 Sample Component Information screen



To select a component:

1. From the Component Tests menu highlight **Component Tests**.
The Component Tests menu displays the available components for the identified test vehicle (Figure 5-63).

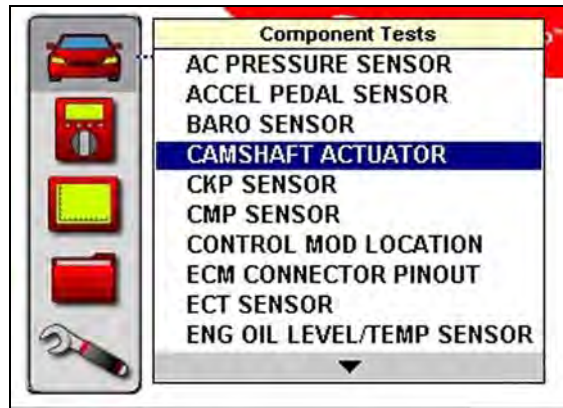

Figure 5-63 Sample Component Tests menu

2. Select a component from the menu.
A component menu displays (Figure 5-64).

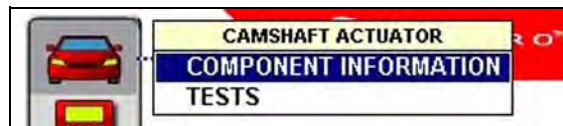

Figure 5-64 Sample component options

3. Select **Component Information**.
The Component Information screen displays (Figure 5-65).

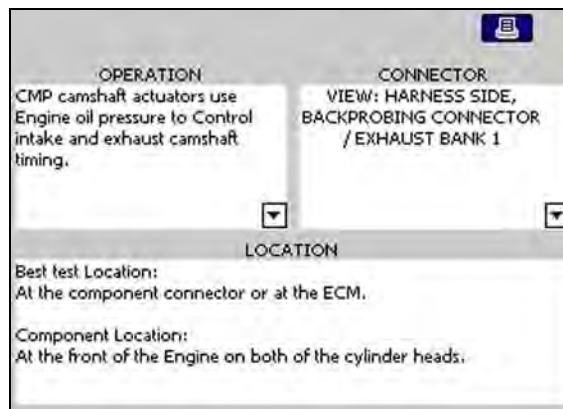

Figure 5-65 Sample Component Information screen

5.7 Features and Benefits

Select **Features and Benefits** to view descriptions of the meter, including features and benefits, specifications, and accessories. Also included is a five minute description of how to use the optional demonstration board to generate sample signals. The demonstration board helps you learn how to better use the Vantage PRO unit without a test vehicle.

5.8 How To

Select **How To** to choose from a list of available on-screen instructions for performing various tasks, such as adjusting the display contrast, calculating engine RPM, and finding glitches in sensors. Drawings are included on the screen along with tips.

Following is a list of common topics, other options may be available on a regional basis.

- **No-start Basics**—provides the ability to diagnose no-starts.
- **10-Minute Electronic Class**—provides brief instruction in basic electronics and circuit connections.
- **15-Minute Ignition Class**—provides an introduction to basic ignition testing.
- **20-Minute Current Ramp Class**—provides an introduction to current ramp classes.
- **O2 Sensor and Feedback System Analysis**—displays the component test meter in the “live” graphing mode with O2S test tips to help you understand the fundamental concepts of O2S diagnostics.
- **Illustrated Terms and Definitions**—provides definitions of terms, drawings and tips associated with component testing.
- **Test Tips**—gives on-screen instructions for performing specific component tests along with drawings and tips.

5.9 Power User Tests

Select **Power User Tests** to use pre-configured control systems tests. The tests are available with or without on-screen help.

This section explains the Multimeter menu and operations.

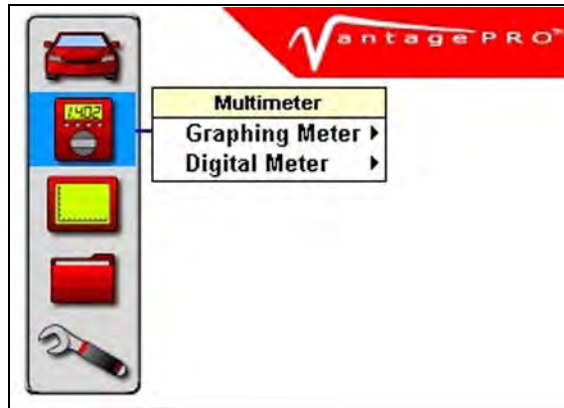

Figure 6-1 Sample Multimeter menu

The Multimeter menu (Figure 6-1) offers the following options:

- Graphing Meter
- Digital Meter

The following is an outline of basic Multimeter software operation.

1. **Select Multimeter software**—Select the type of Multimeter software and a test configuration for the selected tool. See “Selecting Multimeter Software” on page 62.
2. **Connect test leads**—Connect appropriate leads and clips to the Vantage PRO unit. See “Connecting Leads and Clips” on page 21.
3. **Connect the Vantage PRO unit to the vehicle**—Procedures will vary.
4. **Perform the test**—Set up, test, and evaluate test results. See “Performing Multimeter Tests” on page 65.

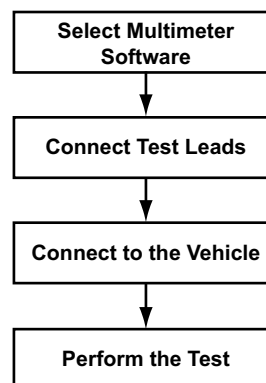

Figure 6-2 Basic Multimeter operations

6.1 Selecting Multimeter Software

There are two types of Multimeter tools available:

- Graphing Meter (See “Graphing Meter” on page 62)
- Digital Meter (See “Digital Meter” on page 63)



To select a Multimeter option:

1. From the main menu, select **Multimeter > Graphing Meter** or **Digital Meter**.
2. Select a test option.

6.1.1 Graphing Meter

Selections from the Graphing Meter menu (Figure 6-3) configure your Vantage PRO unit to function as a color graphing (Figure 6-4 on page 63) or digital meter. The table below describes the test options available.

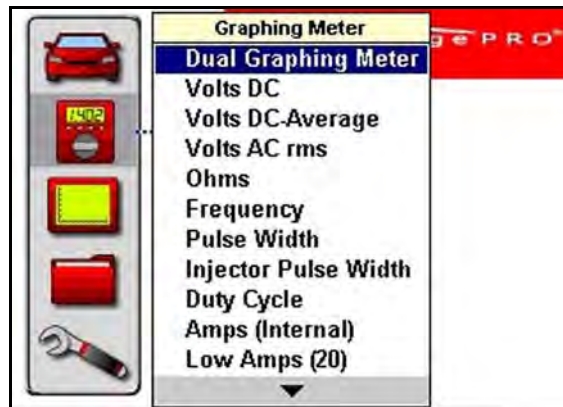

Figure 6-3 Sample Graphing Meter menu

Table 6-1 Graphing Meter test options (part 1 of 2)

Option	Function
Dual Graphing Meter	Displays two channels automatically
Volts DC	Measures direct current voltage
Volts DC-Average	Measures direct current and uses a filter to remove excess noise/hash on the signal
Volts AC rms	Measures the effective voltage rather than the Peak or Average voltage
Ohms	Measures electrical resistance
Frequency	Measures the number of times a signal repeats itself per second
Pulse Width	Measures the on-time of various components
Injector Pulse Width	Measures the on-time of the signal that activates the fuel injector

Table 6-1 Graphing Meter test options (part 2 of 2)

Option	Function
Duty Cycle	Measures the ratio of the pulse width to the complete cycle width, the on-time of components that cycle on and off like EGR, or canister purge from 0–100%
Amps (Internal)	Measures current for component and parasitic draws under 10A when connected in series with the circuit being tested
Low Amps (20)	Measures current from components like ignition coils, injectors, fuel pumps and parasitic draw using the Snap-on Low Amp Probe
Low Amps (40)	Measures current from components like fans and electric motors using the Snap-on Low Amp Probe
MC Dwell (60)	Measures carburetor Mixture Control Solenoids (0–60°)
MC Dwell (90)	Measures fuel system Mixture Control Solenoids (0–90°)
100 psi Vacuum	Measures intake manifold vacuum 0–20 inHg using the Snap-on 0–100 PSI Transducer
100 psi Pressure	Measures fuel systems, engine oil, and transmissions using the Snap-on 0–100 PSI Transducer
500 psi Pressure	Measures transmissions, compression, and AC high side pressure using the Snap-on 0–500 PSI Transducer
5000 psi Pressure	Measures ABS, power steering, and heavy-duty hydraulic systems using the Snap-on 0–5000 PSI Transducer

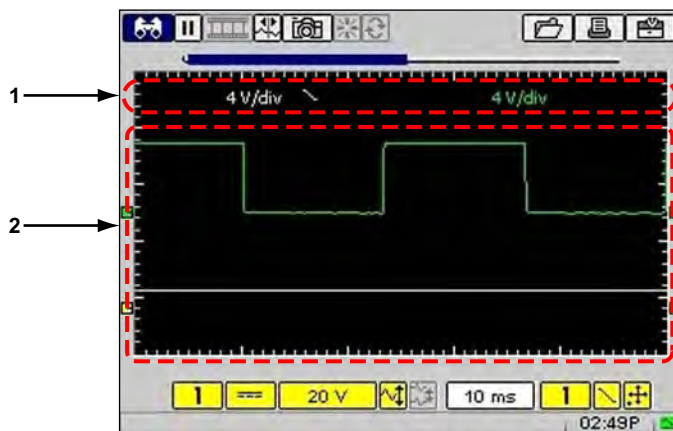

Figure 6-4 Sample Graphing Meter screen

- 1— Channel status information
- 2— Main body

6.1.2 Digital Meter

Selections from the Digital Meter (Figure 6-5) menu configure your Vantage PRO unit to function as a Digital Volt Ohm Meter (DVOM) (Figure 6-6). The table below describes the test options available.

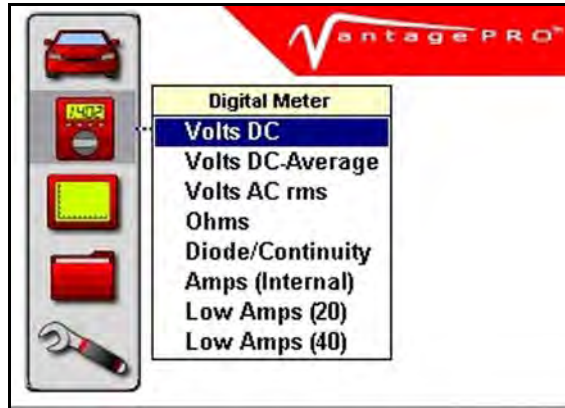

Figure 6-5 Sample Digital Meter menu

Table 6-2 Description of Digital Meter test options

Option	Use
Volts DC	Measures direct current voltage
Volts DC-Average	Measures direct current and uses a filter to remove excess noise/hash on the signal
Volts AC rms	Measures the effective voltage rather than the Peak or Average voltage
Ohms	Measures electrical resistance
Diode/Continuity	Measures voltage drop across a diode or continuity
Amps (Internal)	Measures current for component and parasitic draws under 10A when connected in series with the circuit being tested
Low Amps (20)	Measures current from components like ignition coils, injectors, fuel pumps and parasitic draw using the Snap-on Low Amp Probe
Low Amps (40)	Measures current from components like fans and electric motors using the Snap-on Low Amp Probe



Figure 6-6 Sample Digital Meter test screen

6.2 Performing Multimeter Tests

When performing tests with the Multimeter, the toolbars and controls work the same as those in Component Tests. Button and menu option availability vary depending on your test selection.

For related information, see the following Component Tests Operations sections:

- See “Changing Views” on page 36
- See “Pausing Data” on page 37
- See “Reviewing Data” on page 38
- See “Using Zoom” on page 38
- See “Using Cursors” on page 39
- See “Taking Snapshots” on page 40
- See “Resetting Gauges” on page 42
- See “Saving Data” on page 43
- See “Printing” on page 44
- See “Using Setup” on page 44
- See “Calibration LED” on page 50
- See “Adjusting Channel Settings” on page 50
- See “Setting the Sweep Time” on page 54
- See “Setting the Trigger” on page 55

This section explains the Scope menu and operations.

**NOTE:**

Most of the Scope toolbars and controls work the same as the Multimeter. Only the differences are covered in this section.

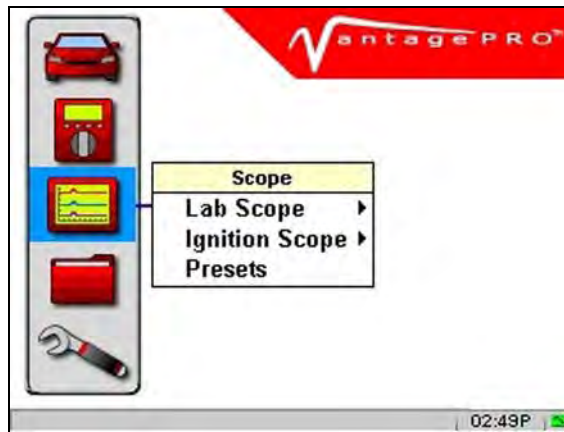

Figure 7-1 Scope selection from main menu

The Scope menu offers the following options (Figure 7-1):

- Lab Scope
- Ignition Scope
- Presets

The following is an outline of basic Scope software operation.

1. **Select Scope Software**—Select the type of Scope software and a test configuration for the selected tool. See “Selecting Scope Software” on page 67.
2. **Connect test leads**—Connect appropriate leads and clips to the Vantage PRO unit. See “Connecting Leads and Clips” on page 21.
3. **Connect the Vantage PRO unit to the vehicle**—Procedures will vary.
4. **Perform the test**—Set up, test, and evaluate test results. See “Performing Scope Tests” on page 73.

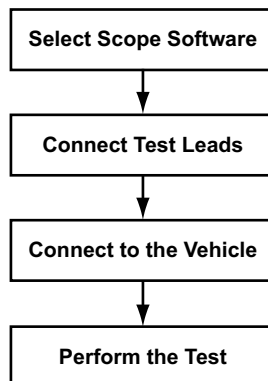

Figure 7-2 Basic Scope operations

7.1 Selecting Scope Software

There are two types of scope tools available:

- Lab Scope (See “Lab Scope” on page 67)
- Ignition Scope (See “Ignition Scope” on page 69)

The following procedures explain how to select a scope tool.



To select scope software:

1. From the main menu, select **Scope > Lab Scope** or **Ignition Scope**.
2. Select a test configuration.

7.1.1 Lab Scope

Selections from the Lab Scope menu (Figure 7-3) configure your Vantage PRO unit to function as a two-channel display. The table below describes the test configuration options available.

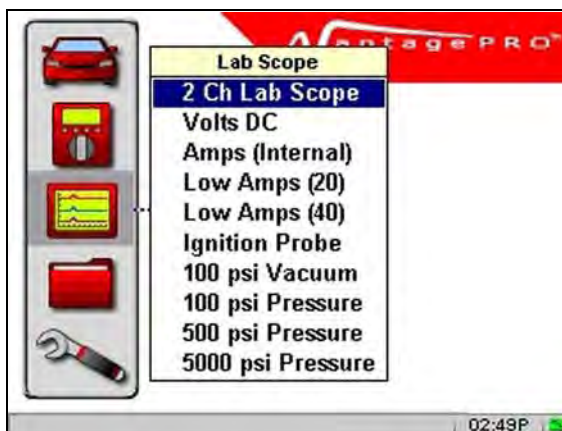

Figure 7-3 Sample Lab Scope menu



NOTE:

The 2 Ch Lab Scope option remembers all settings that are changed for the next use. All other lab scope options will default to the original function.

Table 7-1 Lab Scope test configuration options

Option	Function
2 Ch Lab Scope	Displays two channels automatically. All settings changed in this option will be saved automatically for future use.
Volts DC	Measures direct current voltage
Amps (Internal)	Measures current for component and parasitic draws under 10A when connected in series with the circuit being tested
Low Amps (20)	Measures current from components like ignition coils, injectors, fuel pumps and parasitic draw using the Snap-on Low Amp Probe
Low Amps (40)	Measures current from components like fans and electric motors using the Snap-on Low Amp Probe
Ignition Probe	Measures secondary ignition system voltage using a secondary coil adapter lead and pickups
100 psi Vacuum	Measures engine vacuum 0–20 inHg using the Snap-on 0–100 PSI Transducer
100 psi Pressure	Measures fuel systems, engine oil, and transmissions using the Snap-on 0–100 PSI Transducer
500 psi Pressure	Measures transmissions, compression, and AC high side pressure using the Snap-on 0–500 PSI Transducer
5000 psi Pressure	Measures ABS, power steering, and heavy-duty hydraulic systems using the Snap-on 0–5000 PSI Transducer

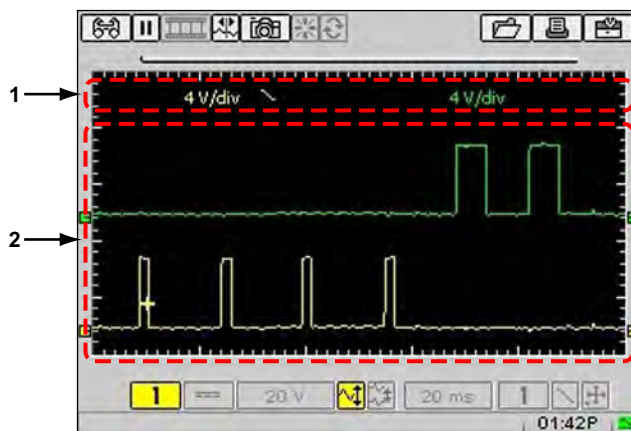

Figure 7-4 Sample Lab Scope screen

- 1— Channel status information
- 2— Main body

7.1.2 Ignition Scope

The Ignition Scope lets you view a secondary waveform using preset ignition pattern display options (Figure 7-5).



Figure 7-5 Sample Ignition Scope submenu

Connecting to all cylinders of an engine at the same time simplifies cylinder comparison in the following ways:

- All cylinders can be viewed at once.
- Each cylinder is displayed once per screen in firing order and is displayed in the same location on-screen.
- The same pattern is displayed regardless of engine rpm.

The Ignition Scope requires the use of two leads.

- **Secondary Coil adapter**—to display the secondary waveform
- **Inductive RPM Pickup adapter**—to identify cylinder number one for proper cylinder order display. Refer to “Connecting Leads and Clips” on page 21 for more details.

Rpm can be calculated from either the grey Inductive RPM pickup adapter or the Secondary Coil adapter. If only the RPM or Secondary Coil adapter is used, rpm will be calculated from whichever lead is connected. If both leads are connected, rpm will be calculated from the grey Inductive rpm pickup.



NOTE:

The optional SIA 2000 Adapter kit is required to connect to multiple cylinders at once on Wasted Spark distributorless ignition systems. Contact your sales representative for details.

Note the following regarding Ignition Scope synchronization:

- Synchronization to cylinder number one takes a couple of seconds after you start the engine.
 - Cylinder firings may be observed to change position during the synchronization process.
 - If the Ignition Scope settings are changed, cylinder synchronization reoccurs.
-



NOTE:

When testing Waste Spark systems, power firings will display on Channel One and waste on Channel Two.

Ignition Patterns

Four ignition pattern options (Figure 7-5 on page 69) are available to view and compare the secondary waveform for all engine cylinders (Figure 7-6).

- The Parade pattern displays the secondary waveform for each cylinder in the firing order from left to right across the screen.
- The Cylinder pattern displays the secondary waveform for the selected cylinder.
- The Raster pattern displays the secondary waveform for each cylinder in the firing order, starting with cylinder number one at the bottom.
- The Superimposed pattern displays the secondary waveform for each cylinder in the firing order stacked on top of each other.



Figure 7-6 Sample ignition pattern screen

Single Cylinder Ignition

The **Single Cylinder Ignition** option (Figure 7-7) configures the scan tool to connect to an individual cylinder using a fixed time sweep when a lead is not available to connect to all cylinders.



Figure 7-7 Sample Ignition Scope submenu

Ignition Scope Probe

In the lower toolbar, the Channel One (1) **Probe** button setting is restricted to Ignition Probe. The Channel Two (2) **Probe** button setting is not restricted and functions the same as in the Lab Scope. See "Probe" on page 52 for more details.

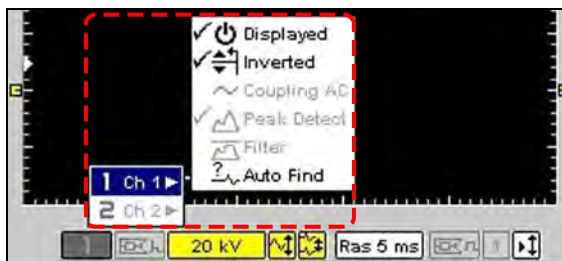

Figure 7-8 Sample Channel one's fixed Peak Detect option

Sensitivity Adjustment

The **Sensitivity Adjustment** button (Figure 7-9) lets you set the detection sensitivity to cylinder firings. The lower the setting, the more sensitive the ignition scope will be to detecting cylinder firing. Being able to adjust the sensitivity and improve cylinder detection increases the range of vehicles that can be tested and the range of secondary pickups that can be used.

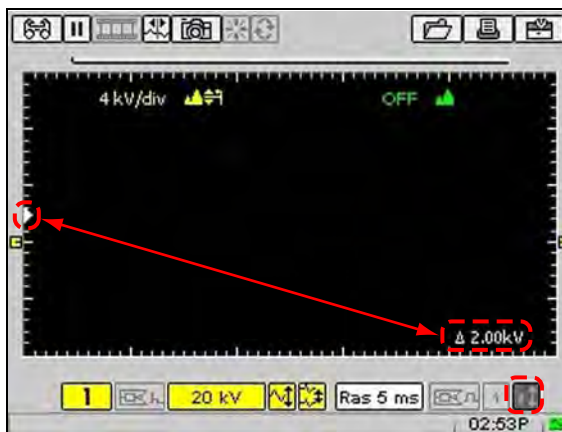

Figure 7-9 Sample ignition trigger adjustment



To adjust cylinder firing detection sensitivity:

1. Select the **Sensitivity Adjustment** button.
The button appears depressed and remains highlighted to indicate that the function is on.
2. Press the up ▲ or down ▼ arrows as needed to move the level indicator on the left of the graph (x-axis).



NOTE:

Unless you are having problems detecting cylinders, a sensitivity setting of 2.0 kV is optimal for many ignition systems.

3. When you are finished setting the ignition scope sensitivity, press **N/X** to deselect the button.



NOTE:

With Wasted Spark ignition systems, the sensitivity level setting only displays on Channel 1, but the setting applies to both channels.

See "Using Sensitivity Adjustment" on page 110 for usage details.

Missed Cylinder Detection

When a cylinder firing is not detected because it is either firing too low to be detected at the current setting or is not firing at all, a blank space displays on-screen (Figure 7-10).



Figure 7-10 Sample missing cylinder detection



To verify a missing cylinder firing:

- Lower the sensitivity setting to verify that the cylinder is firing, but firing too low to be detected at the current sensitivity setting.

If a cylinder is not firing at all, the blank space on the graph will remain.

See “Using Sensitivity Adjustment” on page 110 for more details.

Digital kV View

When using the ignition scope, the **Digital kV** view selection (Figure 7-11) displays the digital kV readings corresponding to the selected channel of the ignition scope and provides another way to monitor the secondary ignition system. When testing Wasted Spark ignition systems, Power firings display on channel one and Wasted Spark firings display on channel two.



NOTE:

The digital values will only be as good as the source waveform. If there is a problem with the lead connection or set up and a stable waveform is not displayed, the digital value may not be calculated correctly. If problems are experienced with the digital values, check lead connections and Ignition Setup. If the measurement cannot be calculated, dashes will display in place of digital values.



Figure 7-11 Sample Digital kV menu selection

Firing kV, Spark kV, and Spark Duration (burn) measurements are calculated from the secondary waveform.

- **Firing kV (FKV)**—voltage required to overcome the rotor and spark plug gaps and establish a spark across the spark plug electrodes.

- **Spark kV (SKV)**—voltage required to maintain a spark across the spark plug electrodes.
- **Spark Duration (Burn)**—time the spark is maintained across the spark plug electrodes.

Min/Max and current values for Firing kV, Spark kV, and Spark Duration are displayed for each cylinder in the firing order. Intermittent problems that happen too fast to be seen on the live waveform will be captured in the Min/Max reading, making it possible to spot problems that can be difficult to see in the live waveform (Figure 7-12).



Figure 7-12 Sample digital kV view

Multiple Spark Ignition Systems

On vehicles with multiple spark ignition systems, when more than one spark per cylinder is present, Firing kV (FKV) is calculated at the start of the first spark and Spark kV (SKV) and Burn are calculated from the last spark.



To calculate the Digital kV and Burn measurements:

- Select an ignition pattern with a 10 ms sweep, such as Parade 10 ms or Cyl 10 ms when testing a multiple spark system.

IMPORTANT:

Digital kV cannot be correctly calculated if, in the Ignition Scope view, the end of the last spark for each cylinder is near the end of the screen or off of the screen.

7.2 Performing Scope Tests

When performing tests with the Scope, the toolbars and controls work the same as those in Component Tests. Button and menu option availability vary depending on your test selection.

For related information, see the following Component Tests Operations sections:

- See “Changing Views” on page 36
- See “Pausing Data” on page 37
- See “Reviewing Data” on page 38
- See “Using Zoom” on page 38

- See “Using Cursors” on page 39
- See “Taking Snapshots” on page 40
- See “Resetting Gauges” on page 42
- See “Saving Data” on page 43
- See “Printing” on page 44
- See “Using Setup” on page 44
- See “Calibration LED” on page 50
- See “Adjusting Channel Settings” on page 50
- See “Setting the Sweep Time” on page 54
- See “Setting the Trigger” on page 55

7.3 Using Presets

A preset is the configuration of your screen setup. The **Presets** option gives you access to all of your custom presets and factory-installed presets for commonly-tested components.

Custom presets can be saved from any of the Scope tool **Save** menus (Figure 7-14). See “Saving Data” on page 43 for more details.

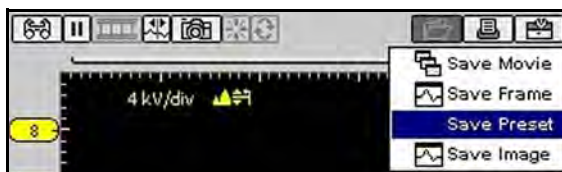

Figure 7-13 Sample Save Preset option

The Presets Management screen (Figure 7-14) displays a list of all the available presets.

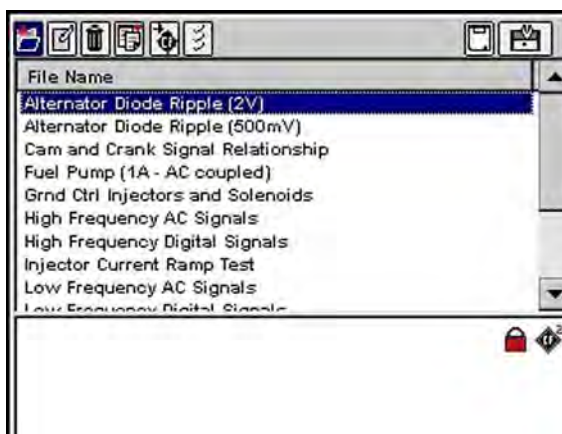

Figure 7-14 Sample Preset Management screen



NOTE:

Factory-installed presets are identified by a lock icon alongside their name and cannot be edited, deleted, copied or moved.

The Preset Management screen toolbars and controls (Figure 7-14) work the same way as in the Data Management screen in Saved Data with the exception of editing saved presets. See “Data Management” on page 80 for details.

- ▶ **To open the Preset Management screen:**
 - From the main menu, select **Scope > Presets**.
The Preset Management screen displays (Figure 7-14).
- ▶ **To exit the Preset Management screen:**
 - Press **N/X** until you return to the main menu.

7.3.1 Loading Saved Presets

The **Load** button opens an active test screen with the selected preset.

- ▶ **To load a preset:**
 1. From the main menu, select **Scope > Presets** (Figure 7-15).

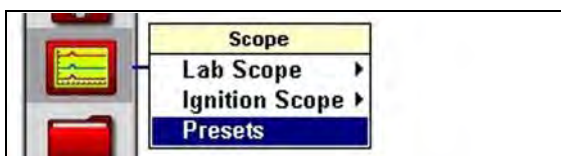

Figure 7-15 Scope menu

The Preset Management screen displays (Figure 7-16).

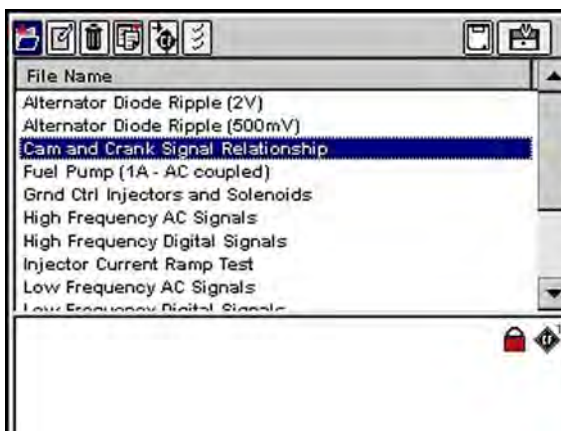

Figure 7-16 Sample preset load selection

2. Highlight a preset from the list.
3. Select the **Load** button.
A scope screen displays with your selected preset configuration.

7.3.2 Editing Presets

The **Edit** button lets you edit presets in the following ways:

- Add notes
- Change filename

**NOTE:**

A USB keyboard (not supplied) is required to edit presets.

**To edit a preset:**

1. From the main menu, select **Scope > Presets**.
The Preset Management screen displays (Figure 7-14 on page 74).
2. Plug in your USB keyboard.
3. Highlight a preset from the list.
4. Select the Edit button.
The Edit Preset Name And Note dialog box displays (Figure 7-17).

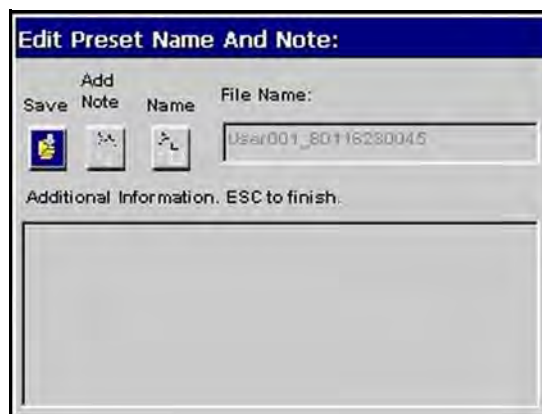

Figure 7-17 Sample Edit Preset Name And Note dialog box

**NOTE:**

The **Notes** and **Name** icons are not active if a keyboard is not plugged in.

5. Select **Notes**.
The Additional Information section activates (Figure 7-18).

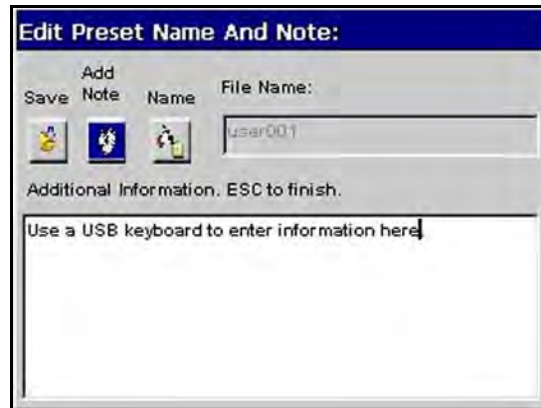

Figure 7-18 Sample Note selection

6. Using your keyboard, type a text note (7 lines maximum), then press **Esc** to exit the Additional Information section.
7. Select **Name**.
The File Name field is now active (Figure 7-19).



Figure 7-19 Sample Name selection

8. Using your keyboard, type a file name, then press **Esc** to exit the **File Name** field.



NOTE:

If you do not provide a file name, a name is automatically created for you ("User00x", for example).

9. Select **Save**.
After processing your edits, you return to the Preset Management screen (Figure 7-14 on page 74).

7.3.3 Deleting Presets

The **Delete** button deletes preset files from system memory.

**To delete presets:**

1. From the main menu, select **Scope > Preset**.
The Preset Management screen displays (Figure 7-16 on page 75).
2. Highlight a preset from the list.
3. Select the **Delete** button.
A confirmation message displays (Figure 7-20).



Figure 7-20 Sample Delete file confirmation message

4. Permanently remove the preset from memory by pressing **Y/✓**.
After processing your delete request, you are returned to the Preset Management screen.

7.3.4 Copying and Moving Presets

The **Copy** and **Move** buttons let you change the storage location of your custom presets. These functions require the use of a CF card in the CF2 card slot. Copy and Move presets go to the inactive CF card.

For example:

If you designate the CF1 as your **Save To** storage memory preference, when you use the **Copy** and **Move** buttons, your selected preset goes to CF2 (Inactive CF card).

**To copy or move data:**

1. Insert a CF card in the CF2 card slot (not supplied).
2. From the main menu, select **Scope > Preset**.
The Preset Management screen displays (Figure 7-16 on page 75).
3. From the upper toolbar, select **Setup**.
The Save Data dialog box displays.
4. Select your source storage memory preference from the **Save To** options, and then press **N/X** to close the dialog box.
This will be the storage memory you will be viewing and copying or moving presets from.
5. When selecting a file from the list on-screen, use the up ▲ and down ▼ arrows.
6. When selecting Copy or Move from the upper toolbar, use the right ► and left ◀ arrows.
A confirmation message displays.
7. Press **Y/✓** to close the dialog box.
You return to the Preset Management screen.

**To verify the preset copied or moved:**

1. Leave the CF2 card installed.
2. From the upper toolbar, select **Setup**.
The Save Data dialog box displays.

3. Select the destination storage memory preference from the **Save To** options, and then press **N/X** to close the dialog box.

When the Preset Management screen displays, you should see the preset(s) that you copied or moved from your source storage memory.

7.3.5 Selecting Multiple Presets

The **Select All** button highlights all the presets so you can delete, copy, or move all of the files simultaneously.

This section explains the Saved Data menu and Data Management operations. The **Saved Data** button (Figure 8-1) accesses the Data Management screen.

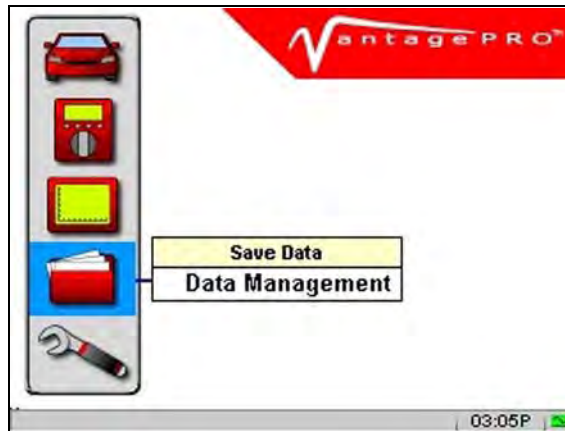

Figure 8-1 Sample Saved Data button menu

The Data Management screen (Figure 8-2) lets you manage storage memory and saved files.



NOTE:

Factory-installed files, identified by a lock icon, cannot be edited, deleted, copied, or moved.

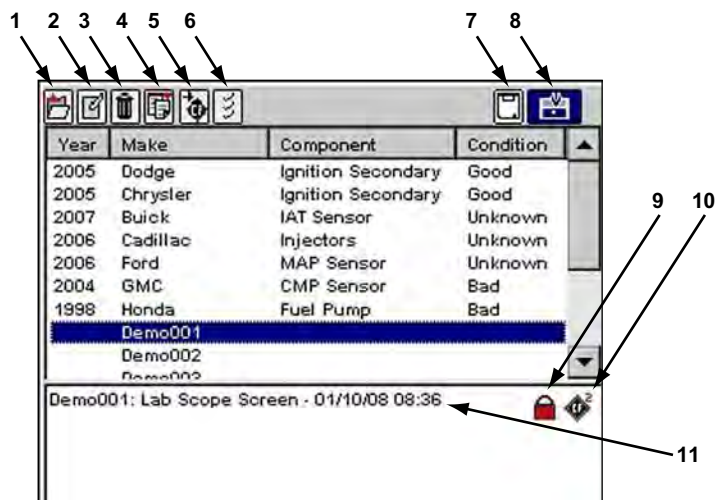

Figure 8-2 Sample Data Management screen

1— Load

Opens the selected file.

2— Edit

Lets you add identifiers and notes to a saved file.

3— Delete

Erases the saved file(s) from storage memory.

4— Copy

Lets you copy the selected file(s) from one CF slot to the other.

5— Move

Lets you move the selected file(s) from one CF slot to the other.

6— Select All

Selects all files.

7— Information

Lets you see how many saved files you have and how much memory is available.

8— Setup

Provides a shortcut to the Save Data utility dialog box that lets you set the location where files are saved. See “Save Data” on page 89 for details.

9— Lock Status Indicator

Displays a lock icon when indicating that the file is factory-installed.

10—Storage Location Indicator

Indicates to which CF card the file is saved.

11—Additional Information

Displays module source, type of data (screen, movie or snapshot), date, time, any custom notes, lock status and storage location information.

8.1 Identifying Saved Files

Saved files can display the following identification information:

- Year is the vehicle model year.
- Make is the vehicle manufacturer.
- Sensor is the component tested.
- Condition is for good, bad, or unknown status options.

For related information, refer to the following sections:

- “Saving Data” on page 43
- “Editing Saved Files” on page 82

8.2 Loading Saved Files

The **Load** button lets you view saved test data and do the following:

- Modify the data view using the **Zoom**, **Setup**, **Channel Number**, **Signal Zero Offset**, and **Cursors** buttons.
- Review data using the **Review** button if the saved data contains more than one screen.
- Print the screen.

**To load data:**

1. From the main menu, select **Saved Data > Data Management**.
The Data Management screen displays (Figure 8-2 on page 80).
2. When selecting a file from the list on-screen, use the up ▲ and down ▼ arrows.
3. When selecting **Load** from the upper toolbar, use the right ► and left ◀ arrows.

**To exit the loaded screen:**

1. Press **N/X** to return to the Data Management screen.
2. Press **N/X** again to return to the main menu.

8.3 Editing Saved Files

The **Edit** button lets you add notes to saved test data. You can also provide Year, Make, Component, and Condition details.

**To edit a saved file:**

1. Plug in a USB keyboard (not supplied).
2. From the main menu, select **Saved Data > Data Management**.
The Data Management screen displays (Figure 8-2 on page 80).
3. When selecting a file from the list on-screen, use the up ▲ and down ▼ arrows.
4. When selecting **Edit** from the upper toolbar, use the right ► and left ◀ arrows.
The Edit Saved Data Notation dialog box displays (Figure 8-3).

Add				
Save Note	Year	Make	Component	Condition
	2005	Chrysler	Ignition Secondary	Good

Figure 8-3 Sample Edit Saved Data Notation dialog box

**NOTE:**

The Add Note button is only active when a USB keyboard is plugged in.

5. Select the Add Note icon.
The Note section displays (Figure 8-4).

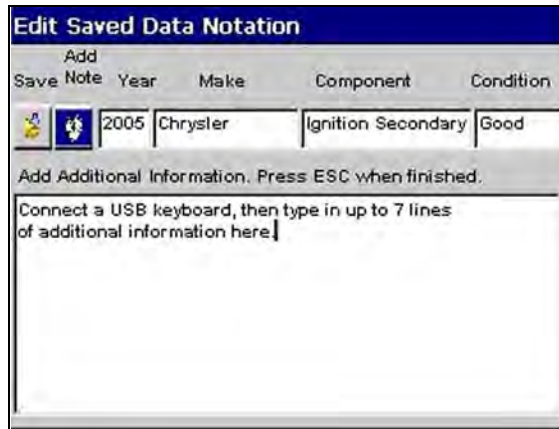

Figure 8-4 Sample Add Note section

6. Using your keyboard, type a note (7 lines maximum), then press **Esc** to exit Additional Information.
7. Select the **Year**, **Make**, **Component**, or **Tested** option. A drop-down list displays (Figure 8-5).



Figure 8-5 Sample Make list in Edit Saved Data Notation

8. Select options from the drop-down lists as appropriate.
9. Select Save when you are finished to return to the Data Management screen.



To exit Edit Data screen:

- Press **N/X** to return to the main menu.

8.4 Deleting Saved Files

The **Delete** button lets you delete saved test data.



To delete files:

1. From the main menu, select **Saved Data > Data Management**.
The Data Management screen displays (Figure 8-2 on page 80).

2. When selecting a file from the list on-screen, use the up ▲ and down ▼ arrows.
3. When selecting **Delete** from the upper toolbar, use the right ► and left ◀ arrows.
A confirmation message displays (Figure 8-6).

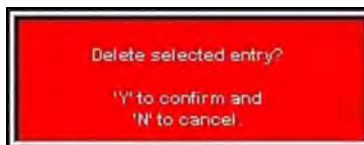

Figure 8-6 Sample Delete file confirmation message

4. Press **N/X** to cancel or press **Y/✓** to permanently erase the data from memory.

8.5 Copying and Moving Saved Data

The **Copy** and **Move** functions let you change the CF card location of your saved data. These functions require the use of an additional CF card in the CF 2 slot.



To copy or move data:

1. Insert a CF card in the CF 2 slot (not supplied).
2. From the main menu, select **Saved Data > Data Management**.
The Data Management screen displays (Figure 8-2 on page 80).
3. From the upper toolbar, select **Setup**.
The Save Data dialog box displays.
4. Select your source CF card slot as the **Save To** option and press **N** to close the dialog box.
5. When selecting a file from the list on-screen, use the up ▲ and down ▼ arrows.
6. When selecting **Copy** or **Move** from the upper toolbar, use the right ► and left ◀ arrows.
A confirmation message displays.
7. Press **Y/✓** to acknowledge the message and close the dialog box.
You return to the Data Management screen.



To verify data copied or moved:

1. Leave the destination CF card installed.

IMPORTANT:

When your Vantage PRO unit is powered on, never remove the master program card from the CF 1 slot.

2. From the upper toolbar, select **Setup**.
The Save Data dialog box displays.
3. Select your destination CF card slot as the **Save To** option and press **N** to exit.
When the Data Management screen displays, you should see the file(s) that you copied or moved from your source CF card.

8.6 Selecting All Files

The **Select All** button highlights all saved data so you can delete, copy, or move all of the files simultaneously.

8.7 Backing up Saved Files

You can back up saved data on your master program CF card to an additional CF card for storage.



To back up saved data:

1. Insert a CF card in the CF 2 slot (not supplied).
2. From the main menu, select **Saved Data > Data Management**.
The Data Management screen displays (Figure 8-2 on page 80).
3. From the upper toolbar, select **Setup**.
The Save Data dialog box displays.
4. Set **CF 1** as the **Save To** option and press **N** to close the dialog box.
The test data saved to CF 1 (master program CF card) displays.
5. Press the **Select All** button to highlight all the saved files at once, or highlight an individual file.
6. Select **Copy** or **Move** to complete the transfer to the CF 2 card.



To verify the backup transfer of saved data:

1. With the CF card in the CF 2 slot, from the upper toolbar, select **Setup**.
The Save Data dialog box displays.
2. Set **CF 2** as the **Save To** option and press **N** to close the dialog box.
The transferred files should display on CF 2.



To exit the Data Management screen:

- Press **N/X** to the main menu.

This section explains the Utilities menu and operations.

The **Utilities** button accesses system information and various system controls (Figure 9-1).



Figure 9-1 Sample Utilities menu

The following utilities options may be available:

- Tool Setup
- System Tools
- Tool Help
- Easy Scroll
- Connect to PC
- Run
- Shop Info
- System Info



NOTE:

Some of these utilities are also accessible from the module you are using in the upper toolbar Setup menu.

9.1 Tool Setup

The **Tool Setup** menu (Figure 9-2) lets you adjust settings for optimum performance.

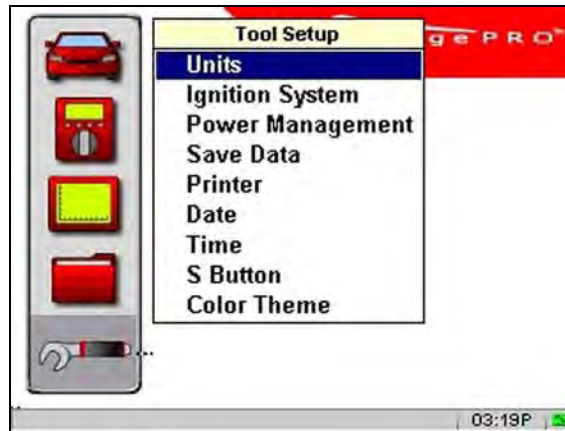

Figure 9-2 *Tool Setup sample menu*

The Tool Setup submenu may include:

- Units
- Ignition System
- Power Management
- Save Data
- Printer
- Date
- Time
- S Button
- Color Theme

9.1.1 Units

Select **Units** (Figure 9-3) to change the displayed units of measurement.

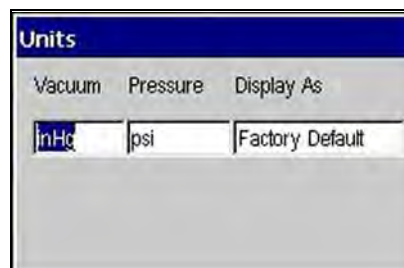

Figure 9-3 *Sample Units dialog box*

Display As sets how the scale units are displayed (Figure 9-4).



Figure 9-4 Display As menu sample



To change the units of measurement:

1. From the main menu, select **Utilities > Tool Setup > Units**.
The Units dialog box displays (Figure 9-4).
2. Select options from the drop-down lists as necessary.
The drop-down lists close when **Y/✓** is pressed.
3. Press **N/X** to close the Units dialog box.

9.1.2 Ignition System

Select **Ignition System** to choose the appropriate parameters for the vehicle you are testing, such as ignition type, number of cylinders, firing order, polarity, # 1 trigger, or rpm factor (Figure 9-5).

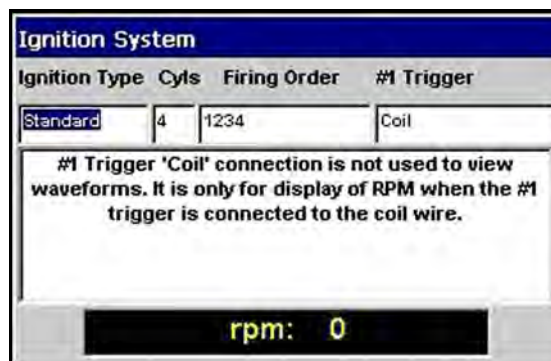

Figure 9-5 Sample Ignition System dialog box

9.1.3 Power Management

Select **Power Management** (Figure 9-6) to control the time before the following occurs:

- The backlight turns off
- The unit goes into standby mode
- The unit turns off

The following time setting rules apply:

- The backlight only turns off if its time setting is shorter than the Standby time setting.
- The unit must be in Standby mode before it can turn off according to the time setting.



Figure 9-6 Sample Power Management dialog box

For related information, see “Powering Off the Unit” on page 22.



To set power management options:

1. Select **Utilities > Tool Setup > Power Management**.
2. Select settings from the dropdown menus.
The drop-down lists close when **Y/✓** is pressed.
3. Press **N/X** to confirm your selection and close the Power Management dialog box.

9.1.4 Save Data

Select **Save Data** to adjust the size of each snapshot and the amount of data recorded after a snapshot trigger-point. Save Data also lets you set the saving and loading location for saved files.



To adjust snapshot preferences:

1. From the main menu, select **Utilities > Tool Setup > Save Data**.
The Save Data dialog box displays (Figure 9-7).

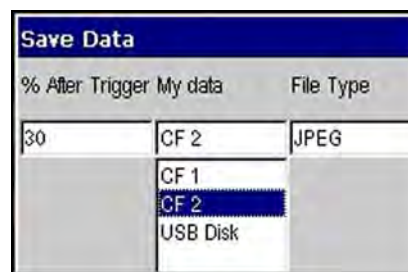

Figure 9-7 Sample Save Data dialog box

2. Select from the drop-down lists as necessary.
The drop-down list closes automatically.
3. Press **N/X** to close the Save Data dialog box.



NOTE:

The Save Data dialog box can also be accessed from the Setup menu on the Saved Data management screen. Refer to “Data Management” on page 80 for details.

9.1.5 Printer

Select **Printer** to check the printer compatibility status.

Your Vantage PRO unit supports USB printing to PCL 3 (Printer Command Language Level 3) printers. Contact the Hewlett-Packard Development Company to see if your printer supports the PCL 3 standard.

See “Setting Up to Print” on page 22 for more details.



To adjust print settings:

1. From the main menu, select **Utilities > Tool Setup > Printer**.
The Printer dialog box displays (Figure 9-8).



Figure 9-8 Sample Printer dialog box

2. Select from the drop-down lists as necessary.
The drop-down lists close when **Y/✓** is pressed.
3. Press **N/X** to close the Printer dialog box.

9.1.6 Date

Select **Date** to set the date that displays with saved data.



To set the date:

1. From the main menu, select **Utilities > Tool Setup > Date**.
The Date dialog box displays (Figure 9-9).



Figure 9-9 Sample Date dialog box

2. Select from the drop-down lists as necessary.
The drop-down list closes when **Y/✓** is pressed.

3. Press **N/X** to close the Date dialog box.

9.1.7 Time

Select **Time** to set the time that displays at the bottom of the screen.



To set the time:

1. From the main menu, select **Utilities > Tool Setup > Time**.
The Time dialog box displays (Figure 9-10).

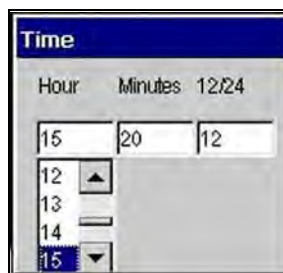

Figure 9-10 Sample Time dialog box

2. Select from the drop-down lists as necessary.
The drop-down list closes when **Y/✓** is pressed.
3. Press **N/X** to close the Time dialog box.

9.1.8 S Button

Select **S Button** to change the functionality of the **S** button. Possible assignments include:

- **Freeze/Run**—works as the **Pause/Play** button when viewing data in graph view.
- **Print Page**—works like the **Page** or **Full Screen** options from the **Print** button on the toolbar.



NOTE:

The **S** button can only perform print functions when the **Print** button is visible in the upper toolbar.

- **Save Image**—is the default and makes a bitmap (BMP) or JPEG (JPG) screen capture image of any screen during any mode of operation.



NOTE:

Using an optional CF card reader/writer connected to your computer, saved bitmap files can be retrieved from your designated storage CF card from the **User\Data** directory.

- **S-Button Popup**—opens this menu when the button is pushed.



To assign a function to the S button:

1. Select **Utilities > Tool Setup > S Button**.
2. The S Button dialog box displays (Figure 9-11).



Figure 9-11 Sample S Button dialog box

3. Select a function from the drop-down list.
The drop-down lists close when **Y/✓** is pressed.
4. Press **N/X** to close the dialog box.

9.1.9 Color Theme

Selecting Color Theme lets you change the background on the display. Using the black background helps conserve battery power.



To change the screen background:

1. Select **Utilities > Tool Setup > Color Theme**.
The **Color Theme** dialog box displays.
2. Press **Y/✓** to open the dropdown list (Figure 9-12).



Figure 9-12 Sample Color Theme dialog box

3. Select a function from the dropdown list.
4. Press **N/X** to close the dialog box.

9.2 System Tools

The **System Tools** menu (Figure 9-13) lets you add programs, update the system software and restore your software.

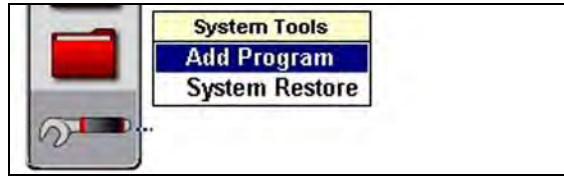

Figure 9-13 *System Tools sample menu*

The System Tools Setup submenu includes:

- Add Program
- System Restore

9.2.1 Add Program

When specified, select **Add Program** to add additional programs to your Vantage PRO software. Follow the installation instructions that come with the software.

9.2.2 System Restore

The **System Restore** function reverts the master storage CF card in slot 1 back into an installation CF card. This will cause the system software to be reinstalled.



To restore the system software:

1. Select **Utilities > System Tools > System Restore**.
2. A warning dialog will launch.
To proceed with restoring your system, Press **Y/✓**.
To return to the menu, Press **N/X**.
3. A confirmation message will appear and the master storage CF card has now been reverted to an installation CF card.
4. In order to complete the system restore process, turn off the unit.
5. Power on the unit. The newly reverted installation CF card will begin the installation process. When this process is complete, the system has been restored.

9.3 Tool Help

Tool Help provides information from this manual on your Vantage PRO unit.



To use Tool Help:

1. From the main menu, select **Utilities > Tool Help**.
The Tool Help Table of Contents screen displays (Figure 9-14).



Figure 9-14 Sample Tool Help Table of Contents screen

2. Select a topic from the Table of Contents screen.
3. Select a book and press **Y/✓** to expand the contents.
4. Press the right **▶** arrow to view a selected topic or book text screen.
5. Use the up **▲** and down **▼** arrows to view additional text.
6. Press the left **◀** arrow to return to the Table of Contents screen.
7. Select a book and press **Y/✓** to collapse the contents.



To exit Tool Help:

- Press **N/X** twice.

9.4 Easy Scroll

The **Easy Scroll** utility functions as a selection shortcut that lets you use only the Thumb Pad arrows to highlight and select an item.

Refer to “Easy Scroll” on page 29 for more details.



To turn Easy Scroll on and off:

- Select **Utilities > Easy Scroll** (Figure 9-11).



Figure 9-15 Easy Scroll turned on

A check mark to the left of the Easy Scroll option displays.

**NOTE:**

Easy Scroll stays on until you manually turn it off.

9.5 Connect to PC

The **Connect to PC** selection is used with the optional ShopStream Connect™ software, which lets you view data files on a computer and share files.

9.6 Run

When specified, select **Run** to load Snap-on authorized applications.

9.7 Shop Info

Select the **Shop Info** option to enter or view ownership information for the unit.

**To enter unit identification:**

1. Select **Utilities > Shop Info**.

The Shop Information dialog box displays (Figure 9-16).

Figure 9-16 Sample Shop Information dialog box.

2. Plug in a USB keyboard (not supplied).
3. Type the shop identification information in the available data fields.
4. Press **Esc** to close the dialog box, and unplug the keyboard.
5. Select **Utilities > Shop Info** to verify that the identification information displays properly, and press **N/X** to close the dialog box.

A message offering to include your information as a header on your printed pages displays (Figure 9-17).

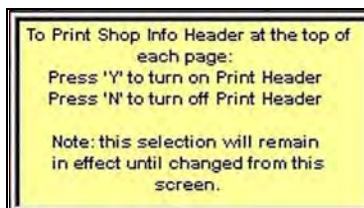

Figure 9-17 Sample Shop Info header printing message

6. Press **Y/✓** or **N/X** to choose your printing preference.

9.8 System Info

Select **System Info** to display your unit's configuration information.



To view unit configuration information:

1. Scroll to select **Utilities > System Info**.

The System Information screen displays (Figure 9-18).



Figure 9-18 Example System Information screen

2. Press the down ▼ arrow to view the following screens of information.
3. Press the up ▲ arrow to return to the previously viewed screen or press **N/X** twice to return to the main menu.

This section explains the following maintenance issues:

- Cleaning and damage inspection
- Battery pack
- CompactFlash® cards
- Storage tips
- Disposal requirements (environmental hazards)

10.1 Cleaning and Damage Inspection

When using the Vantage PRO unit, make sure to do the following:

- Before and after each use, check the housing, wiring, and connectors for dirt and damage.
- At the end of each working day, clean the housing, wiring, and connectors with a soft cloth and gentle all-purpose cleaner.

IMPORTANT:

Avoid using abrasive or corrosive cleaning products, especially when cleaning the screen.

10.2 Battery Pack

To prolong the life of your battery pack when your Vantage PRO unit is not in use, power off your Vantage PRO unit and remove the battery pack.

10.2.1 Replacing the Battery Pack

When your battery pack no longer holds a charge, call your Snap-on dealer to order a new one. Refer to “Using the Battery Pack” on page 17 for more details.

After replacing the old battery, call Rechargeable Battery Recycling Corporation (RBRC) at 1(800) 822-8837 (USA), or refer to their web site at <http://www.rbrc.org> for the nearest recycling location and instructions for proper battery disposal.

10.3 10-Amp Fuse

The Vantage PRO unit uses one 10-amp mini fuse to protect the amp circuit. The fuse is located in the back of the unit (Figure 10-1).

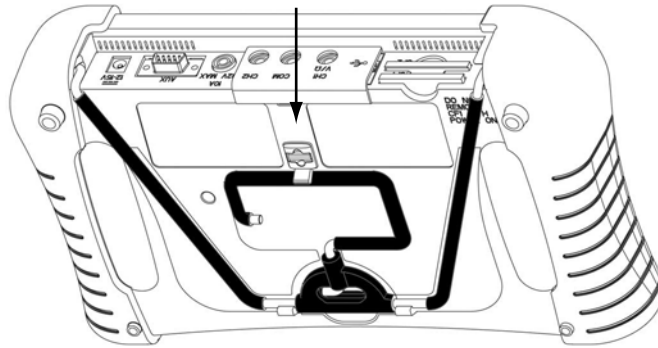

Figure 10-1 Sample Fuse location

If undamaged, the fuse should never need replacing.

IMPORTANT:

Follow the precautions below to avoid damage to the tool.

- Do not reverse the vehicle power connection to a battery while using the test leads.
- Do not replace the 10-amp fuse with a higher-amp fuse.



To replace the fuse:

1. Turn the Vantage PRO unit off.
2. Using a fuse puller or needle nose pliers, carefully grasp the fuse and remove it from the back of the unit.
3. Insert the new 10-amp fuse into the fuse slot in the back of unit.

10.4 CompactFlash® (CF) Cards

Software updates are released on CF card media that inserts into your Vantage PRO unit. Refer to the instructions accompanying the CF card for installation procedures. Once installed, the CF card is linked to your tool and will not operate on any other Vantage PRO unit.

10.5 Storage Tips

When storing your Vantage PRO unit, remember the following:

- Always turn the Vantage PRO unit off.
- Keep in mind the storage temperature range.
- Remove the battery when storage time is extensive.

10.6 Disposal Requirements

Always dispose of materials according to local regulations.

The following are solutions for problems that can occur while using your Vantage PRO unit.

A.1 Battery Pack Not Charging

If the battery pack does not charge:

- The battery pack may not be installed in the battery charger unit properly.
Make sure the battery charger unit is receiving power; and, without using force, adjust the battery pack installation in the battery charger unit until the red status light displays.
- The battery pack may be too hot.
Allow the battery pack to cool to at least 104°F (40°C). If left in the battery charger unit, once the proper room temperature is achieved, charging will begin.
- The battery pack may be too cold.
Allow the battery pack to warm to at least 32°F (0°C). If left in the battery charger unit, once the proper room temperature is achieved, charging will begin.
- The battery pack may be dead.
The battery pack must be replaced. See “Replacing the Battery Pack” on page 97. Use another power source to continue working. See “Supplying Power” on page 17.

A.2 Unit Will Not Power On

The following conditions will prevent your Vantage PRO unit from powering on:

- No master storage CF card in CF Slot 1.
- No or discharged battery pack and no auxiliary power connected. See “Supplying Power” on page 17.

A.3 Emergency Restart

If your Vantage PRO unit Pauses or will not power off, you can perform an emergency restart.



To perform an emergency restart:

1. Remove the left handgrip.
2. Locate the emergency restart button in the lower right corner on the back of the unit (Figure A-1).

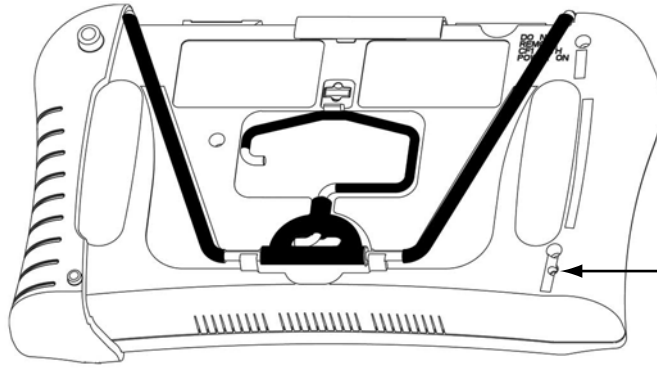

Figure A-1 *Emergency restart button location*

3. Gently insert a toothpick or some other non-metallic item into the emergency reset button hole and depress the button.
The unit restarts.

Peak Detect is used to capture fast events, spikes and glitches for signals going in positive and negative directions. See “Adjusting Channel Settings” on page 50.

B.1 When To Use Peak Detect

The following section explains when you might want to use Peak Detect and how it works.

When Peak Detect is off—the scope collects just enough data to plot a waveform across the screen. This is the standard mode of operation for many scopes.

Example:

If the Sweep setting is 10 seconds and the screen was 100 points wide, the sample rate would be 10 times a second. If the Sweep setting is decreased to 1 second, the sample rate would increase to 100 times a second.

When Peak Detect is on—the scope samples at the maximum rate possible and captures more sample points than needed to plot the screen. This lets you catch a fast event or glitch.

B.1.1 Example—Testing Secondary Ignition

At a Sweep setting of 1 ms (Figure B-1), firing voltage will be captured even if Peak Detect is off (the sample rate is relatively fast at this time setting).

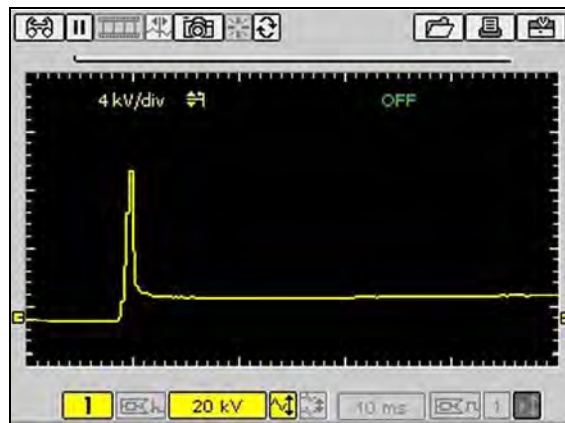

Figure B-1 Sample 1 ms Sweep—Peak Detect off

As the Sweep setting is increased, the firing voltage may be observed to decrease in height and vary more than usual, and the peak firing voltage will not be captured consistently (Figure B-2).



Figure B-2 Sample 10 ms Sweep—Peak Detect off

At longer sweeps, the sample rate is slower and the peak firing voltage or the entire firing can be missed if it happens between samples (Figure B-3).



Figure B-3 Sample 10 ms Sweep—Peak Detect off

When Peak Detect is on, the firings will be displayed regardless of the Sweep because the scope is sampling at the maximum rate. The longer the Sweep, the more useful Peak Detect can be.

Figure B-4 illustrates a Firing Peak captured at a 10 ms Sweep rate. Compare this illustration with Figure B-3 on page 102.



Figure B-4 Sample 10 ms Sweep—Peak Detect on

B.1.2 Example—Testing a TPS for Glitches

With a sweep of 5 or 10 seconds, typically used for testing a throttle position sensor (TPS), the sample rate is relatively slow. When a sweep is longer, the sample rate is slower, which increases the chance that a glitch can be missed because it occurred in between samples.

Figure B-5 illustrates a TPS glitch not captured.

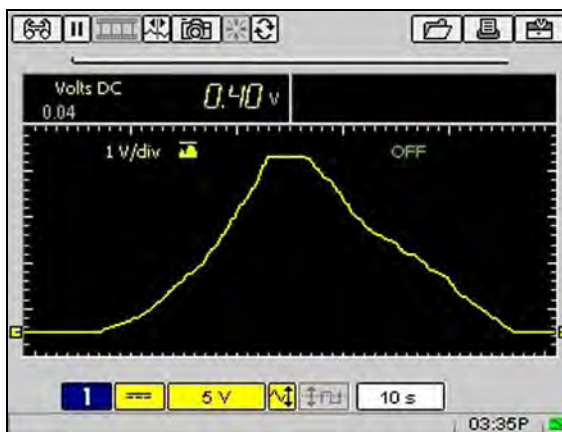

Figure B-5 Sample Slow Sweep—TPS Glitch not captured

To increase the chance of capturing a glitch without Peak Detect, a shorter sweep is needed.

Figure B-6 illustrates a TPS Glitch captured using a faster Sweep.

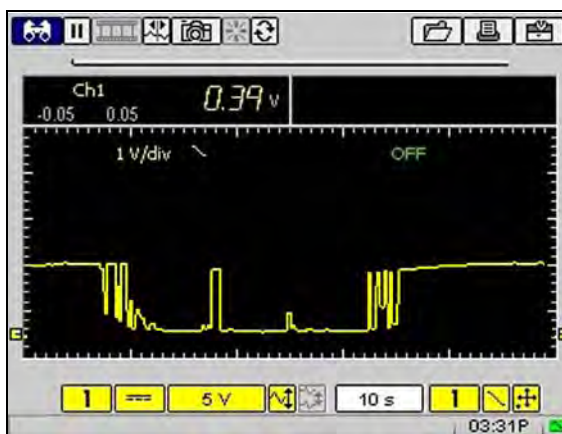

Figure B-6 Sample Faster Sweep—TPS Glitch captured

Even if the glitch was captured, with a sweep this short the glitch could easily be missed if you looked away for a moment or even blinked.

When Peak Detect is on, the scope is sampling at the maximum rate a signal glitch can be captured using a longer sweep where it will be easy to see.

Figure B-7 illustrates a TPS Glitch captured using a 10 second sweep. Compare this illustration with Figure B-5 on page 103.

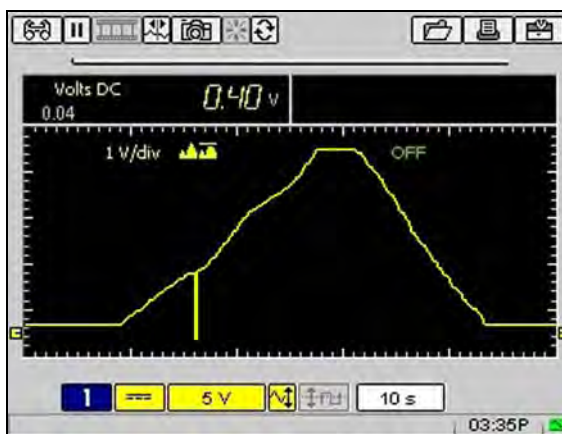

Figure B-7 Sample 10 Second Sweep—TPS Glitch captured

B.2 When Not to Use Peak Detect

Peak Detect puts the scope in a high speed sampling mode which can pick up and display unwanted noise from components such as injectors and solenoids.

B.2.1 Example—Testing an Oxygen Sensor

An Oxygen (O₂) sensor signal is relatively slow and requires, a clean, noise-free pattern for an accurate diagnosis.

Peak Detect should be off when testing an O₂ sensor, because the waveform is much cleaner and easier to evaluate since less noise displays (Figure B-8).



Figure B-8 Sample O₂ waveform with Peak Detect off

When Peak Detect is on, more noise is picked up, which makes diagnosis difficult (Figure B-9).

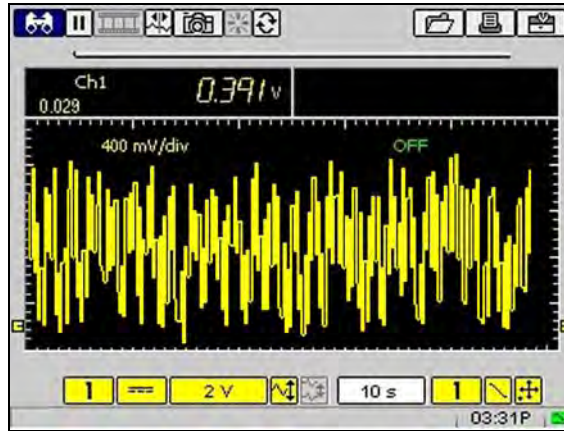

Figure B-9 Sample O2 waveform with Peak Detect on

B.3 Peak Detect and the Graphing Meter

The Graphing Meter uses a combination of Filter and Peak Detect modes. Filter removes the unwanted ignition and other high frequency signals from the display, which gives a better view of the signal of interest.

The combination of Filter and Peak Detect gives a good balance between detecting fast glitches and preventing unwanted noise from displaying. The Noise Filter can be selected from the Channel Control bar as applicable.

For related information, see the following sections:

- “Adjusting Channel Settings” on page 50
- “Scope Filter Use” on page 109

If glitches are being detected and no vehicle problems are observed, noise may be the cause. As a precaution, do the following:

- Use shielded leads
- Route the leads away from secondary ignition components.
- Verify the test connections.
- If noise is still suspected to be a problem, turn on the Filter. See “Channel Number” on page 51 for procedures.

**NOTE:**

The Filter may also eliminate extremely fast glitches.

C.1 When to Use Filter

The following sections explain when to use the filter with the Graphing Meter and the Scope.

C.1.1 Graphing Meter Filter Use

In the Graphing Meter, the filter minimizes noise by ignoring or smoothing out fast spikes.

Calculated Measurements

When conducting a calculated measurement test (Frequency Pulse Width, MC Dwell or Duty Cycle) the filter is used to ignore very fast spikes (20 μ S and faster) from sources like the ignition system.

Figure C-1 illustrates noise from the ignition system when conducting the Graphing Meter Frequency test with Peak Detect on and Filter off.

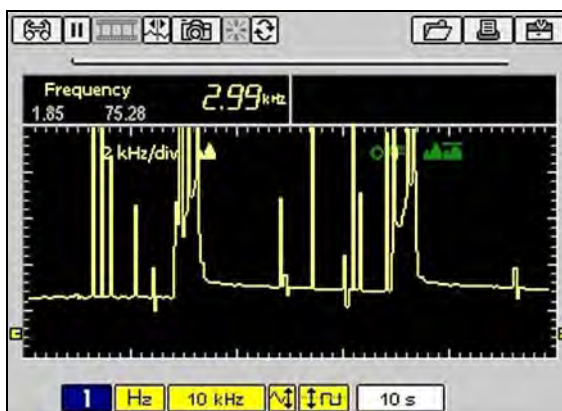

Figure C-1 Sample of Frequency with Filter off

Figure C-2 illustrates the noise filtered out when conducting the same test with the filter on.

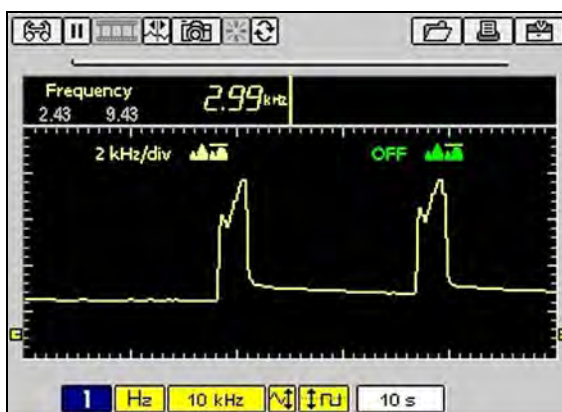

Figure C-2 Sample of Frequency with Filter on

Direct Measurements

When you conduct a direct measurement test in the Graphing Meter (Volts, Amps, or Pressure), the filter minimizes the display of very fast spikes by averaging the data. When used together, Filter and Peak Detect balance capturing glitches and minimizing noise.

Figure C-3 illustrates Peak Detect on and Filter off during a TPS Sweep with the key on and engine off (KOEO).



Figure C-3 Sample Noise Filter off—TPS Sweep (KOEO)

Figure C-4 illustrates Peak Detect on and Filter on during a TPS Sweep with the key on and engine off (KOEO).



Figure C-4 Sample of Noise Filter on—TPS Sweep (KOEO)

Figure C-5 illustrates Peak Detect on and Filter off during a TPS test. The throttle was snapped with the engine running (KOER). Compare this with Figure C-6, taken under the same conditions but with the Filter on.

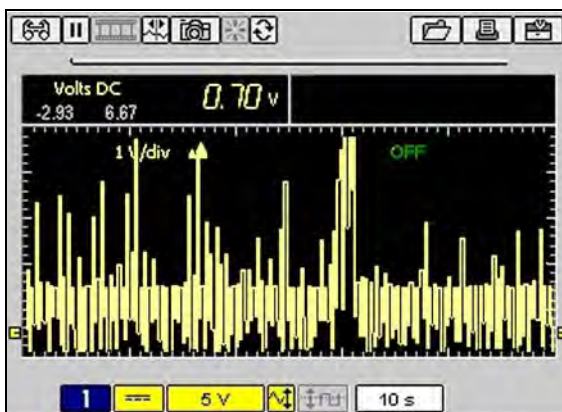

Figure C-5 Sample Noise Filter off—TPS Sweep (KOER)

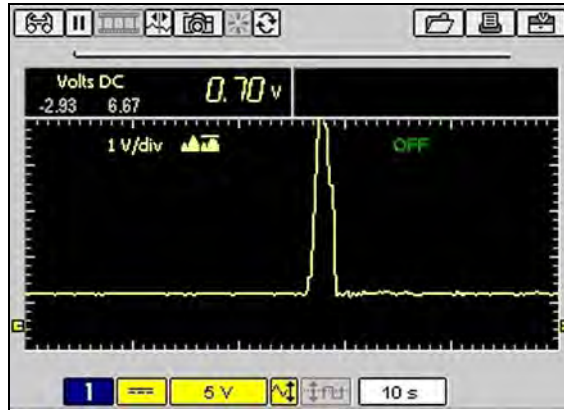

Figure C-6 Sample Noise Filter on—TPS Sweep (KOER)

C.1.2 Scope Filter Use

In the Scope, Filter smooths out spikes and fast variations in the waveform, which provides a good balance between noise suppression and signal integrity and is most useful on scales of 5 volts and below. The lower the volts scale, the more likely noise could be a problem.

Testing an O₂ sensor using a 1 or 2 volt scale or testing with an amps probe would be examples of when Filter might be used. Due to the conversion factors used by the probes, a very small volts scale is used to measure the output of the probe.

For a probe with a conversion factor of 100 mV/A connected to a 2 amp load, the scope would use a 200 mV scale to measure the output of the probe. The scope then converts the measured output to 2 amps for display on the screen.

In Figure C-7, 2 low amps probes were connected to the same injector to compare the waveform with Filter on and off.



Figure C-7 Sample Noise Filter—two low amp scope probes

Channel 1 uses the Filter and Channel 2 does not use the Filter.

Notice the difference in readings.

Sensitivity Adjustment is used in the Ignition Scope to set the detection sensitivity of cylinder firings. See “Sensitivity Adjustment” on page 71 and “Missed Cylinder Detection” on page 72 for additional information.

D.1 When To Use Sensitivity Adjustment

The sensitivity adjustment affects the ability of the ignition scope to detect ignition firings.

Generally it is best to set the sensitivity level just above the spark (Figure D-1).



Figure D-1 Sample of correct sensitivity adjustment

D.1.1 Improper Sensitivity Adjustments

Setting the cylinder firing sensitivity is essential for the proper display of the secondary pattern.

- If the sensitivity is set too high, cylinder firings may not be detected and firing peaks may not get detected on multiple spark ignition systems.
- If the sensitivity is set too low, events other than the cylinder firings may be falsely detected as cylinder firings.

The following examples illustrate what happens when the Sensitivity Adjustments are set too high and too low.

Sensitivity Set Too High

Cylinder firings may not be detected consistently if the sensitivity setting is too high. A blank will be displayed in place of a cylinder that is not detected (Figure D-2).

Lowering the setting will allow the scope to detect the firings consistently.

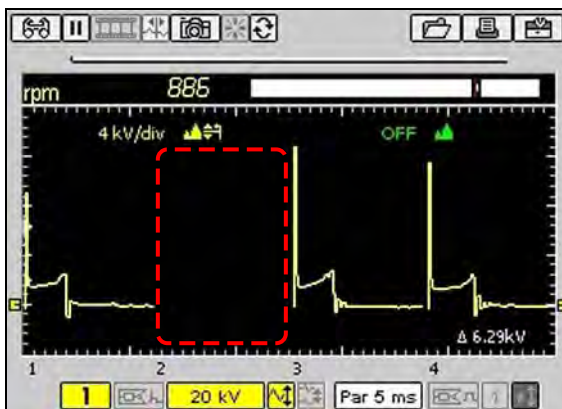

Figure D-2 Sample of sensitivity adjustment set too high



NOTE:

If a cylinder is not firing at all, it cannot be displayed and will remain a blank space on-screen

Multiple Spark Systems

When testing a multiple spark ignition system, if the scope sensitivity is set too high, firing peaks can be intermittently missed and the Digital kV value does not calculate correctly (Figure D-3).

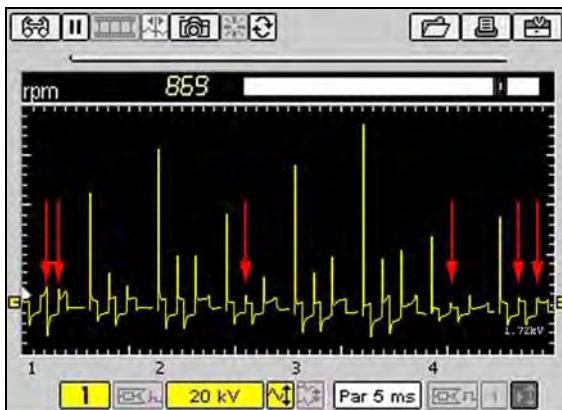

Figure D-3 Sample of missing peaks

Lowering the scope sensitivity captures all of the firing peaks consistently and calculates the Digital kV measurement correctly (Figure D-4).

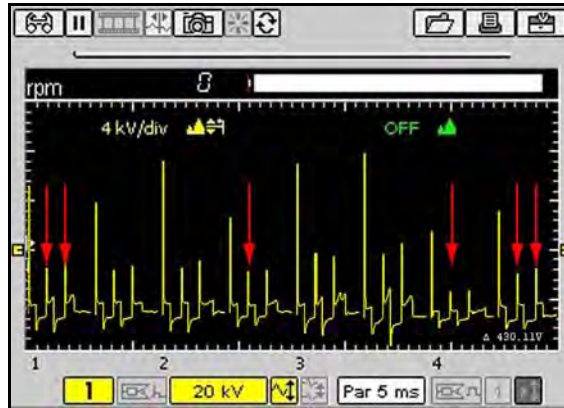

Figure D-4 Sample of properly set sensitivity for Multiple Spark systems

Sensitivity Set Too Low

When other events are detected as cylinder firings, the detection sensitivity may be set too low. The setting should be increased until the ignition scope consistently detects each cylinder firing.

Figure D-5 illustrates the detection sensitivity level set at 500V which is too low because the start of Dwell is being displayed as the firing of cylinders 3 and 2.

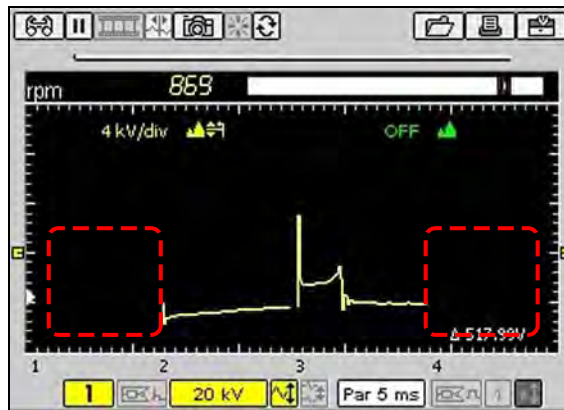

Figure D-5 Sample of sensitivity adjustment set too low

Figure D-6 illustrates the start of Dwell being detected as a cylinder firing on the secondary waveform because the sensitivity adjustment is set too low.

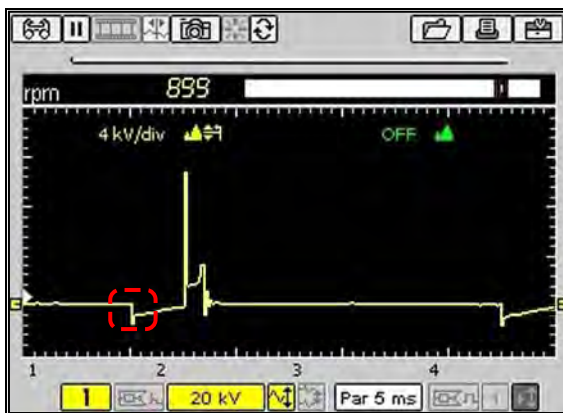

Figure D-6 Sample of sensitivity adjustment set too low

D.2 Some Common Ignition Problems

This section explains how to set the sensitivity level properly when you encounter some common ignition system problems.

D.2.1 Example—Vehicle With A Shorted Spark-Plug

Figure D-7 illustrates inaccurate cylinder firing detection on a vehicle with a carbon-fouled spark plug. The spark plug on cylinder 3 was severely carbon fouled. In the illustration, the detection sensitivity level is set too high and the cylinder is not being detected consistently.

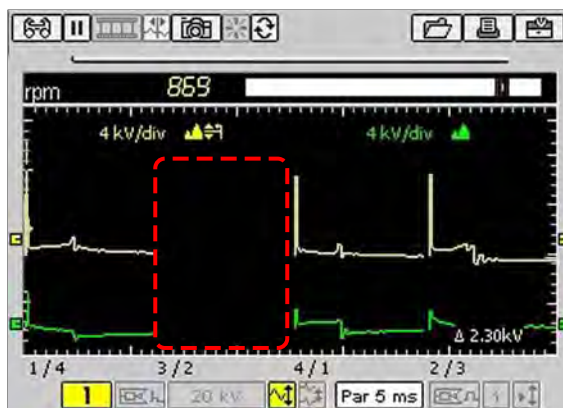

Figure D-7 Sample sensitivity set too high

Decreasing the detection sensitivity to 1.5 kV, as illustrated in Figure D-8, resulted in the consistent detection of the shorted cylinder.



Figure D-8 Sample shorted spark-plug detected

D.2.2 Example—Vehicle With A Coil Not Firing

Figure D-9 illustrates accurate cylinder firing detection on a vehicle with the 6/3 coil not firing. Lowering the detection sensitivity does not help because there are no firings from the 6/3 coil.



Figure D-9 Sample 6/3 coil not firing and not detected

The actual cylinder spacing can be seen by changing to the 200 ms fixed time sweep and viewing the raw waveform on channels 1 and 2. The cylinder spacing (long/short/long/short) verifies a coil is not firing (Figure D-10).



Figure D-10 Sample raw waveform of coil not firing

Index

Numerics

10-Minute Electronic Class, 60
15-Minute Ignition Class, 60

A

AC power adapter
 technical specifications, 7
AC voltage, 10
AC/DC power adapter, 13
adding notes. See editing data
adjustment, 71
alligator clips, 16
amps, 7, 8
 connecting, 5

B

back up saved files, 85
backlight, 88
batteries, 7
battery pack
 about, 14
 charger, 14
 charging, 17
 disposing of, 97
 extending the life of, 18
 installing, 18
 low battery warning, 19
 not charging, 99
 power status, 27
 replacing, 97
 time to charge, 18
 using, 17–18
 working when battery is low, 19
brightness/contrast, 5, 20

C

cables, 15–16
 channel 1, 15
 channel 2, 16
 connecting, 21
capabilities
 scope, 8
 test instrument, 8
channel control bar, 50
channel number, 51
color theme setting, 92
CompactFlash® cards
 slot technical specs, 7

component test
 operations, 31–59
component tests, 31–59
 connecting to a vehicle, 35
 features and benefits, 59
 how to, 60
 identify test vehicle, 32
 new vehicle ID, 32
 performing tests, 35–57
 power user tests, 60
 previous vehicles, 33
 selecting a test, 34
 view component information, 57–59
control buttons, 11–12
 brightness/contrast, 12
 N button, 11
 power, 12
 S button, 12
 Thumb Pad, 12
 Y button, 11
cursors, 39

D

DB9F connector, 5
DC power jack, 5
DC voltage, 10
deleting data, 77, 83
diode, 5, 8
display, 7
display as, 45, 87
display trigger, 55–57
disposal requirements, 98
duty cycle, 9
DVOM
 and digital meter, 63

E

easy scroll, 29, 94
edit, 80
editing data, 82
emergency restart, 99

F

Features and Benefits, 59
filter, 105, 106–109
fuse, 7
 replacing, 97

G

grid, 47

H

help. See tool help
How To, 60

I

identifying saved files, 81
identifying the test vehicle, 32
ignition patterns, 69
 cylinder, 70
 parade, 70
 raster, 70
 superimposed, 70
ignition scope, 69–73
 ignition patterns, 69
ignition system, 46
Illustrated Terms and Definitions, 60
inverse colors, 49

J

jump bar, 29

L

lab scope, 67
load, 80
loading data, 75, 81

M

maintenance, 97–98
 10-amp fuse, 97
 battery pack, 97
 cleaning and damage inspection, 97
 CompactFlash® (CF) cards, 98
 disposal requirements, 98
 storage tips, 98
making selections, 27
manual conventions
 notes, 1, 2
master program CF card, 7
MC dwell, 9
multimeter
 digital meter, 63
 graphing meter, 62
 operations, 61–65
 performing tests, 65
 selecting software, 62

N

new vehicle ID, 32
noise filter, 51, 105, 106–109
No-Start Basics, 60

not powering on, 99

O

O2 Sensor & Feedback System Analysis, 60
operating specifications, 7–11
operating temperature, 7

P

pausing data, 37
PC, connect to, 95
peak detect, 51, 101–105
performing tests, 35
power button, 5
power sources, 13–15
Power User Tests. See tests
presets
 copying and moving, 78
 deleting, 77
 editing, 76
 exiting, 75
 loading, 75
 management screen, 75
 selecting all, 79
 using, 74–79
previous vehicles ID, 33
printer setup, 17
printing
 connecting a printer, 90
 printing a screen, 44
probe, 52, 71

R

resetting min/max data, 44

S

S button, 5
safety
 information, iv
saving data, 43
scale, 52
scales display, 49
scope, 73–79
 capabilities, 8
 ignition scope, 69
 lab scope, 67
 operations, 66–77
 performing tests, 73
 presets, 74
 selecting software, 67
 single cylinder ignition, 70
selecting component tests, 34

- setup options, 44
 - grid, 47
 - ignition system, 46
 - inverse colors, 49
 - scales display, 49
 - trigger display, 48
 - units, 45
- setup. See tool setup
- ShopStream Connect, 22
- signal zero offset, 53
- single cylinder ignition, 70
- snapshot, 37, 38, 40–42
- stand, the, 6
- Standby mode, 22
 - setting, 88
- storage temperature, 7
- storage tips, 98
- sweep, 54
- system info, 96

T

- technical specifications, 7
- test instrument capabilities, 8–11
- test leads
 - connecting, 21
- tests
 - Power User, 60
 - tips, 60
- tests leads
 - jacks, 12
- threshold, 53
 - Auto Threshold Select (ATS), 53
 - Manual Threshold Select (MTS), 53
- thumb pad, 4
- tool help, 93
- tool setup, 86, 92
- transflective screen, 4
- trigger display, 48
- trigger. See display trigger

U

- units, 45
- USB keyboard, 76
- USB ports, 5, 13
- Utilities menu
 - Connect to PC, 95

V

- vehicle power adapters, 14
- view options, 36
- viewing component information, 57

Z

- zoom, 38