

PI000™

User Manual



Contents



Quick Links

Using Page Controls   

Table of Contents (TOC)

General Information

Basic Operation & Navigation

Quick Reference Information

Maintenance

ShopStream Connect™

Wi-Fi Connection



Scanner



Previous Vehicles & Data



Tools



Table of Contents

- Safety Information v**
- Using This Manual vii**
- Section 1: Quick Reference 1**
- Section 2: General Information..... 2**
 - Basic Features 2
 - Powering the Diagnostic Tool 3
 - Vehicle Power 3
 - Internal Battery Pack 3
 - AC Power Supply 4
 - Technical Specifications 4
- Section 3: Basic Operation and Navigation 5**
 - Turning On/Off and Emergency Shutdown 5
 - Turning On 5
 - Turning Off 5
 - Emergency Shutdown 5
 - Control Buttons 6
 - Basic Navigation 6
 - Home Screen Layout..... 6
 - Home Screen Icons 7
 - Title Bar 7
 - Common Toolbar Control Icons 8
 - Scroll Bar 8
 - Screen Messages 9
 - Snap-on Messages 9
 - General System Messages 9
 - Vehicle Communication Messages 9
- Section 4: Scanner..... 10**
 - Basic Operation 10
 - Scanner Overview 10
 - Scanner Demonstration Mode..... 11
 - Scanner - Starting / Stopping 11
 - Features and Icons 12
 - Scanner Features 12
 - Scanner Control Icons 12

- Basic Scanner Operation (Quick Start)..... 13
- Data Cable Connection 13
- Vehicle Identification / System Selection 14
- System Main Menu Options 16
- Codes - View / Scan / Save..... 17
 - Viewing Codes 17
 - Clear Codes 17
 - Code Scan 17
- Viewing and Saving Data 20
 - About the Data Buffer 20
 - About Cursors 21
 - Pausing and Reviewing Active Data 21
 - Saving Data Files 23
 - Using Zoom..... 24
 - Changing Data Views - PID List / Graphs 25
 - Selecting PIDs to Display (custom display) 26
 - Locking PIDs (to always display at top) 26
 - Using Triggers..... 27
- Functional Tests 30
- Section 5: Previous Vehicles and Data 32**
 - Previous Vehicles and Data Menu 32
 - Vehicle History 32
 - View Saved Data 33
 - Viewing Codes and Code Scan Results 33
 - Delete Saved Data 35
- Section 6: Tools..... 36**
 - Tools Menu 36
 - Connect-to-PC (File Transfer)..... 37
 - Configure Shortcut Button..... 37
 - System Information 37
 - Settings 38
- Section 7: Wi-Fi Connection / Troubleshooting 44**
 - Checking if Wi-Fi is On/Off 44
 - Checking if Wi-Fi is Connected 44
 - Wi-Fi Icons (Setup)..... 45
 - Turning Wi-Fi On and Connecting to a Network 45



Add Network Advanced (Connecting to a hidden network) 46

Wi-Fi Testing..... 46

Wi-Fi Troubleshooting and Status Messages 47

Section 8: ShopStream Connect™ 50

Using SSC (Connecting to your PC)..... 50

SSC Main Screen 51

Scanner DataViewer 52

Image Viewer 52

Printing the Code Scan Report 53

Customizing the Code Scan Report..... 54

Software Upgrades and Updates..... 55

 End User License Agreement 56

Section 9: Maintenance 57

Cleaning and Inspecting the Diagnostic Tool..... 57

 Cleaning the Touch Screen..... 57

Battery Pack Service..... 57

 Safety 57

 Ordering a New Battery Pack..... 58

 Removing / Installing the Battery Pack..... 58

 Disposing of the Battery Pack 59

Legal Information..... 60



Safety Information

READ ALL INSTRUCTIONS

For your own safety, the safety of others, and to prevent damage to the product and vehicles upon which it is used, it is important that all instructions and safety messages in this manual and the accompanying *Important Safety Instructions* manual be read and understood by all persons operating, or coming into contact with the product, before operating. We suggest you store a copy of each manual near the product in sight of the operator.

For your safety, read all instructions. Use your diagnostic tools only as described in the tool user's manual. Use only manufacturer recommended parts and accessories with your diagnostic tools.

This product is intended for use by properly trained and skilled professional technicians. The safety messages presented throughout this manual and the accompanying *Important Safety Instructions* manual are reminders to the operator to exercise extreme care when using this product.

There are many variations in procedures, techniques, tools, and parts for servicing vehicles, as well as in the skill of the individual doing the work. Because of the vast number of test applications and variations in the products that can be tested with this instrument, we cannot possibly anticipate or provide advice or safety messages to cover every situation. It is the responsibility of the technician to be knowledgeable of the system being tested. It is essential to use proper service methods and test procedures. It is important to perform tests in an appropriate and acceptable manner that does not endanger your safety, the safety of others in the work area, the equipment being used, or the vehicle being tested.

It is assumed that the operator has a thorough understanding of vehicle systems before using this product. Understanding of these system principles and operating theories is necessary for competent, safe and accurate use of this instrument.

Before using the equipment, always refer to and follow the safety messages and applicable test procedures provided by the manufacturer of the vehicle or equipment being tested. Use the product only as described in its user manual. Use only manufacturer recommended parts and accessories with your product.

Read, understand and follow all safety messages and instructions in this manual, the accompanying *Important Safety Instructions* manual, and on the test equipment.

Environmental Conditions:

- This product is intended for indoor use only
- This product is rated for Pollution Degree 2 (normal conditions)

Safety Signal Words

All safety messages contain a safety signal word that indicates the level of the hazard. An icon, when present, gives a graphical description of the hazard. Safety Signal words are:



Indicates an imminently hazardous situation which, if not avoided, will result in death or serious injury to the operator or to bystanders.



Indicates a potentially hazardous situation which, if not avoided, could result in death or serious injury to the operator or to bystanders.



Indicates a potentially hazardous situation which, if not avoided, may result in moderate or minor injury to the operator or to bystanders.



Safety Message Conventions

Safety messages are provided to help prevent personal injury and equipment damage. Safety messages communicate the hazard, hazard avoidance and possible consequences using three different type styles:

- Normal type states the hazard.
- **Bold** type states how to avoid the hazard.
- *Italic type states the possible consequences of not avoiding the hazard.*

An icon, when present, gives a graphical description of the potential hazard.

Safety Message Example



 **WARNING**

Risk of electric shock.

- **Prior to recycling the battery pack, protect exposed terminals with heavy insulating tape to prevent shorting.**
- **Disconnect all test leads and turn diagnostic tools off before removing the battery pack.**
- **Do not attempt to disassemble the battery or remove any component projecting from or protecting the battery terminals.**
- **Do not expose the diagnostic tool or battery pack to rain, snow, or wet conditions.**
- **Do not short circuit the battery terminals.**

Electric shock can cause injury.

Important Safety Instructions

For a complete list of safety messages, refer to the accompanying *Important Safety Instructions manual*.

SAVE THESE INSTRUCTIONS

Using This Manual



Hyperlinks

Selectable hyperlinks are provided throughout this manual to quickly take you to related topics, procedures, and websites. Hyperlinks are identified by **Blue** colored text.

Text Hyperlink Example: <http://diagnostics.snapon.com>

Page Navigation Controls

The following navigation controls are provided on the top of each page of the user manual. They can be used in addition to the viewer controls in the toolbar.

Icon	Description
Quick Links Menu	Opens the Quick Links menu within the Table of Contents (TOC) section. From Quick Links you can link to most topics in this manual.
Jump Back	Click to move back one page.
Jump Forward	Click to move forward one page.

Content

IMPORTANT

This manual is intended to be used for P1000 motorcycle scanner operations. For automotive operations, see the Ethos Edge user manual at: <http://diagnostics.snapon.com/usermanuals>

This manual contains basic operating instructions and is structured in a manner to help you become familiar with your diagnostic tool features and perform basic operations.

The illustrations in this manual are intended as reference only and may not depict actual screen results, information, functions or standard equipment. Contact your sales representative for availability of other functions and optional equipment.

Conventions

The following conventions are used.

Terminology

The term “Vehicle” is used throughout this manual, and is used to describe or refer to a motorcycle in general terms.

The terms “Scanner” and “Scanner function” are used to describe the Scanner Function(s) of the diagnostic tool.

Examples:

- Select **Scanner** from the Home screen.
- From the Scanner main menu select **Continue**.
- The Scanner function provides many diagnostic tests.

The term “select” describes tapping/touching an icon on the touch screen, or highlighting an icon or menu choice and then selecting the confirmation menu choice such as **Continue, Accept, OK, Yes, or other similar** choice.



Abbreviated example for the following procedure: “Select **Brightness**”

1. Navigate to and highlight the **Brightness** selection.
2. Select **OK, or similar,** button.

Symbols

Different types of arrows are used. The “greater than” arrow (>) indicates an abbreviated set of selection (navigation) instructions.

Abbreviated example for the following procedure: “Select **Tools > Connect-to-PC**”

1. Select **Tools** from the home screen.
2. Highlight **Connect-to-PC** on the Tools menu.
3. Select **Connect-to-PC**.

The solid arrows (◀, ▶, ▼, ▲) are navigational instructions for the four directions of the directional buttons.

Example: Press the down ▼ arrow.

Bold Text

Bold emphasis is used in procedures to highlight selectable items such as control buttons, icons and menu options.

Example: Press the **OK** button

Notes and Important Messages

The following messages are used.

Notes

A NOTE provides helpful information such as additional explanations, tips, and comments.

Example:

NOTE

For additional information refer to...

Important

IMPORTANT indicates a situation which, if not avoided, may result in damage to the test equipment or vehicle.

Example:

IMPORTANT

Do not disconnect the data cable while the diagnostic tool is communicating with the ECM.

IMPORTANT

Read all applicable [Safety Information](#) before using this diagnostic tool!

Procedures

An arrow icon in the left-margin area indicates a procedure.

Example:



To change screen views:

1. Select the **Graph** icon.
The dropdown menu displays.
2. Select an option from the menu.
The screen layout changes to the format selected.



Finding the Diagnostic Tool Serial Number and Software Version

The diagnostic tool serial number is located on the back of the diagnostic tool housing. The serial number can also be viewed onscreen from the System Information screen (**Tools > System Information**) see [System Information on page 37](#),

The diagnostic tool software version can be viewed onscreen from the System Information screen (**Tools > System Information**) see [System Information on page 37](#).

Support Contact Information

Phone / E-mail - Technical Assistance

1-800-424-7226 / diagnostics_support@snapon.com

or use our online contact form

- <https://www1.snapon.com/diagnostics/us/Contact>

Website Links:

Snap-on Diagnostics and Information

- <http://diagnostics.snapon.com>

Manuals / Technical Documentation - The information in this manual is periodically revised to ensure the latest information is included. Download the latest version of this manual and other related technical documentation at:

- <http://diagnostics.snapon.com/usermanuals>

For technical assistance in all other markets, contact your selling agent.

ShopStream Connect

Download ShopStream Connect our free PC-based companion software used to print, transfer, save, manage, review, annotate, e-mail the saved or recorded files on your Snap-on diagnostic tool. See [ShopStream Connect™ on page 50](#)

Website URL - <http://diagnostics.snapon.com/ssc>

Printing Data and Screenshots

Use ShopStream Connect to print code scan reports, data files and screenshots from the diagnostic tool. See [ShopStream Connect™ on page 50](#).

Accessories

Available Smart Vehicle Interface (SVI) adapters:

- HARLEY-DAVIDSON (HAR-2)
- BMW (BM-2)
- INDIAN and VICTORY (POL-1)
- DUCATI (DUC-1)
- SUZUKI (SUZ-1)
- HONDA (HON-2)
- KAWASAKI (KAW-1) and (KAW-2)
- YAMAHA (YAM-1)

i NOTE

Items in the list above are subject to change, contact your sales representative to purchase Smart Vehicle Adapters (SVIs) for other Motorcycle manufacturers.

Find diagnostic tool accessories using our Interactive Accessories Catalog: visit <http://diagnostics.snapon.com> and enter “accessories catalog” in the Search field.



The P1000™ is a multi-functional diagnostic tool designed for motorcycle and automotive use.

IMPORTANT

This manual is intended to be used for P1000 motorcycle scanner operations. For automotive operations, see the Ethos Edge user manual at: <http://diagnostics.snapon.com/usermanuals>

This section describes basic feature locations, how the diagnostic tool is powered and basic specifications.

Main Topic Links

- [Basic Features](#) page 2
- [Powering the Diagnostic Tool](#) page 3
 - [Vehicle Power](#) page 3
 - [Internal Battery Pack](#) page 3
 - [AC Power Supply](#) page 4
- [Technical Specifications](#) page 4

2.1 Basic Features



- 1— Touch Screen
- 2— Control Panel

Figure 2-1 Front view



- 1— Built-in Stand
- 2— Battery Cover
- 3— Batter Cover Screw

Figure 2-2 Back view

Connectors and jacks for data communication cables and the AC power supply are located on the top of the diagnostic tool.

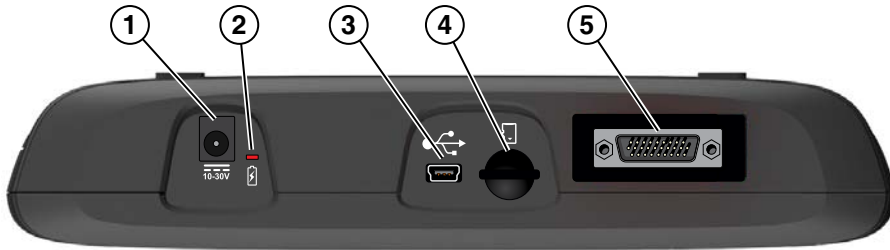

Figure 2-3 Top view

- 1— **Power Supply Jack** - AC power supply connection
- 2— **Battery Status Indicator LED**
- 3— **Mini USB Jack** - USB cable connection used to transfer saved data files to a personal computer
- 4— **Micro secure digital (uSD) Card** - contains operating system programming.
***IMPORTANT** The uSD card must be installed for the diagnostic tool to operate. Do not remove the uSD card while the diagnostic tool is powered on.*
- 5— **Data Cable Connector** - Data cable connection used to connect the diagnostic tool to a motorcycle diagnostic connector.

2.2 Powering the Diagnostic Tool

Your diagnostic tool can receive power from any of the following sources:

- [Vehicle Power](#)
- [Internal Battery Pack](#)
- [AC Power Supply](#)

2.2.1 Vehicle Power

The diagnostic tool is designed to be powered from the vehicle. Most motorcycles have vehicle battery power (B+) available on the motorcycle diagnostic connector. The diagnostic tool is powered through the Data Cable when connected to the motorcycle diagnostic connector.

A green LED indicator on the motorcycle diagnostic connector end of the data cable, illuminates when power is being supplied to the cable. If the LED fails to illuminate, check that the data cable is properly connected and then check the

motorcycle diagnostic connector power circuit. See [Data Cable Connection](#) on page 13 for additional data cable information.

Use the supplied power accessory cable when testing models that do not have battery power (B+) available on the motorcycle diagnostic connector.

IMPORTANT

Never connect the power accessory cable when the diagnostic tool is communicating with a vehicle.

2.2.2 Internal Battery Pack

The diagnostic tool can be powered from the internal rechargeable battery pack. A fully charged battery pack provides sufficient power for about 3 hours of continuous operation. For battery pack removal and installation instructions see, [Removing / Installing the Battery Pack](#) on page 58.

Battery Pack Charging

Battery charging occurs whenever the data cable is connected to a motorcycle diagnostic connector. Battery charging also occurs when the AC power supply is connected to a live AC power source, and connected to the diagnostic tool. Use the supplied AC power supply to charge the battery pack.



Insert the end of the AC power supply cable into the diagnostic tool power supply jack, then connect the AC power supply to an approved AC power source.

IMPORTANT

Only use the supplied AC power supply. Never connect the power supply to the diagnostic tool when the tool is communicating with a vehicle.



The Battery Status Indicator LED (located next to the power supply jack) indicates battery status.

Battery Status LED	Description
	Green - battery is fully charged, or the diagnostic tool is being powered by the AC power supply.
	Red - battery is charging
	Amber - indicates a battery issue. This is usually caused by excessive battery temperature (above 104°F/40°C), which disables charging. Allow the diagnostic tool to cool down before continuing operation.

2.2.3 AC Power Supply

The diagnostic tool can be powered from a standard AC outlet using the AC power supply. The AC power supply converts alternating current (AC) to direct current (DC) to power the diagnostic tool. The connector on the end of the output cable of the AC power supply connects to the AC power supply jack on top of the diagnostic tool. Use only the AC power supply provided.

IMPORTANT

Never connect the AC power supply to the diagnostic tool when the diagnostic tool is communicating with a vehicle.

2.3 Technical Specifications

Item	Description / Specification
Touch Screen	Resistive Touch Panel
Display	5.6 inch diagonal, LCD TFT
	640 x 480 resolution
	24 bit color
Battery Pack	Rechargeable lithium-ion battery pack
	Approximately 3 hour run time
	Approximately 5 hour charge time
Operating System	SMX
Processor	Motorola
Input Operating Voltage	10 to 30VDC
AC Power Supply Rating	Input 110-240VAC, Output 15VDC - 2A
Width	8.90 in. (226 mm)
Height	5.67 in. (144 mm)
Depth	1.75 in. (44.5 mm)
Weight (including battery pack)	2.1 lb (952 g)
Operating Temperature Range (ambient)	At 0 to 90% relative humidity (non-condensing) 32 to 113°F (0 to 45°C)
Storage Temperature (ambient)	At 0 to 70% relative humidity (non-condensing) -4 to 140°F (-20 to 60°C)
Environmental Conditions	This product is intended for indoor use only
	This product is rated for Pollution Degree 2 (normal conditions)



This section describes basic diagnostic tool operation, navigation, screen layout, icon functions, and screen messages. Before you operate the diagnostic tool, make sure the battery pack is fully charged or the diagnostic tool is powered by the AC power supply.

IMPORTANT

This manual is intended to be used for P1000 motorcycle scanner operations. For automotive operations, see the Ethos Edge user manual at: <http://diagnostics.snapon.com/usermanuals>

Main Topic Links

- [Turning On/Off and Emergency Shutdown](#) page 5
- [Control Buttons](#) page 6
- [Basic Navigation](#) page 6
- [Home Screen Icons](#) page 7
- [Common Toolbar Control Icons](#) page 8
- [Screen Messages](#) page 9

3.1 Turning On/Off and Emergency Shutdown

The following sections describe how to turn the diagnostic tool on and off and how to perform an emergency shutdown.

3.1.1 Turning On

To manually turn on the diagnostic tool, press and release the **Power** button (*Figure 3-1*).

The diagnostic tool will automatically turn on when:

- a live AC power supply is connected to the diagnostic tool
- the Data Cable is connected to a motorcycle (that has 12VDC at the motorcycle diagnostic connector)

3.1.2 Turning Off

IMPORTANT

*All vehicle communication must be stopped **BEFORE** turning off the diagnostic tool. A warning message displays if you attempt to turn the diagnostic tool off while communicating with the vehicle. Forcing a shut down while communicating may lead to control module problems on some models. Never disconnect the Data Cable when the diagnostic tool is communicating with the vehicle.*



To turn off the diagnostic tool:

1. Press the **N/Cancel** button or select the **Back** or **Home** icon to navigate to the Home screen.
If applicable, a “stopping communication” message appears briefly before the Home screen displays.
2. If applicable, disconnect the Data Cable from the motorcycle.
3. Press and release the **Power** button.
A confirmation screen displays.
4. Press the **Y/Accept** button or select **OK** from the menu to turn the diagnostic tool off. To continue operating, press the **N/Cancel** button or select **Cancel** from the menu.

3.1.3 Emergency Shutdown

IMPORTANT

Using the emergency shutdown procedure while communicating may lead to control module problems on some models.

During normal operation turn the diagnostic tool off using the *Turning Off* procedure above. The emergency shutdown procedure should only be used if the diagnostic tool does not respond to navigation or control buttons or exhibits erratic operation. To force an emergency shutdown, press and hold the **Power** button for five seconds until the diagnostic tool turns off.

3.2 Control Buttons

There are four “push type” control buttons and one “thumb pad rocker type” multi-directional button located on the right side of the diagnostic tool. All other diagnostic tool operations are controlled through the touch screen.



Figure 3-1 Front view

Item	Button	Description
1		<p>N/Cancel - Push type button</p> <ul style="list-style-type: none"> To exit a menu or program. To close an open list and return to the previous menu or screen. To answer “No” when a yes/no choice is given.
2		<p>Y/Accept - Push type button</p> <ul style="list-style-type: none"> To confirm a selection from a menu or program. To select an item that was highlighted using the direction arrows. To advance to the next screen in a series. To answer “Yes” when a yes or no choice is given.

Item	Button	Description
3		<p>Directional - Thumb pad rocker type buttons</p> <p>Buttons move the cursor or highlight in their respective direction:</p> <ul style="list-style-type: none"> Up (▲) Down (▼) Left (◀) Right (▶)
4		<p>S (Shortcut) - Push type button</p> <p>Programmable function button that can provide a shortcut for performing a variety of routine tasks. Refer to Configure Shortcut Button on page 37 for additional information.</p>
5		<p>Power (On/Off) - Push type button</p> <p>Turns the diagnostic tool on and off. Also, press and hold for 5 seconds for emergency shutdown.</p>

3.3 Basic Navigation

3.3.1 Home Screen Layout

The Home screen includes a title bar and main body. The Home screen contains the primary diagnostic tool function icons.

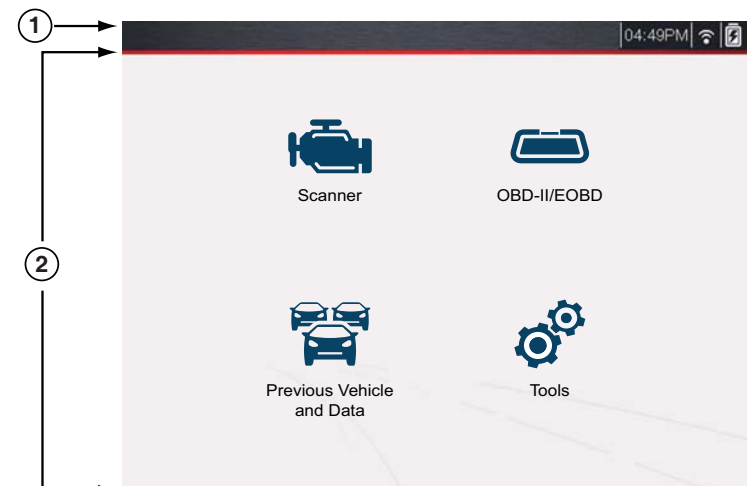

- 1— Title Bar
- 2— Main Body

Figure 3-2 Home screen



3.3.2 Home Screen Icons

Each available diagnostic tool function is represented by a icon on the Home screen. Select an icon from the Home screen to start a function. You can also use the control buttons to select an icon. Use the directional button to highlight the desired function and then press the **Y/Accept** to select it.

Function Name	Function Icon	Description
Scanner		Used to communicate with the control systems of a motorcycle. This function allows you to retrieve diagnostic trouble codes (DTCs), view PID data and perform diagnostic tests. See Scanner on page 10 for details.
OBD-II/EOBD		Allows you to access generic automotive OBD-II/EOBD data and tests without identifying the vehicle being tested. See the Ethos Edge user manual at: http://diagnostics.snapon.com/usermanuals for instructions.
Previous Vehicles & Data		Allows you to quickly reconfigure the diagnostic tool to a recently tested vehicle and to access saved data files. See Previous Vehicles and Data on page 32 for details.
Tools		Allows you to adjust diagnostic tool settings to your personal preferences and perform other special functions. See Tools on page 36 for details.

3.3.3 Title Bar

The title bar ([Figure 3-2](#)) at the top of the screen provides basic information about current diagnostic tool operating conditions. Title bar options vary depending upon motorcycle make and model, what function is active, what test is being performed, or what menu is selected. The title bar contains information only, there are no selectable items.

Elements of the Title bar let you know at a glance:

- Which diagnostic tool function is active
- The current time
- Wi-Fi signal strength
- The source and status of the power being supplied to the diagnostic tool

A real time clock displays to the left of the power supply icon. The clock is powered by a dedicated internal battery, so the correct time is maintained even when the main battery pack is discharged. Use the Tools function to set the clock and format how time is displayed. See [Clock Settings on page 41](#) for additional information.

The Title bar displays other information that varies depending upon what functions are being performed. Other information may include:

- The identification (ID) of the motorcycle
- The name of the active menu or function
- The name of the test being performed

Icon	Function	Icon	Function
	Full Battery Charge Level - Indicates power is being supplied by the internal battery pack. Horizontal bars diminish as the battery discharges.		External Power Connected - Indicates power is being supplied through the data cable connection to a vehicle or by the AC Power Supply and charging the battery pack.
	Low Battery Charge Level - Indicates the internal battery pack is low and needs to be recharged immediately. A warning message will also display on the screen when the battery gets low.		Wi-Fi Signal Strength - Indicates signal strength of the wireless network connection. 3 bars - full strength signal 1 bar - weak signal



3.3.4 Common Toolbar Control Icons

Common control icon functions are described in the following table. Specific function control icons are described in their applicable sections. Displayed control icons vary depending on the active function or test.

Select a control icon to perform a function. You can also use the control buttons to select an icon. Use the directional button to highlight the desired function and then press the **Y/Accept** button to select it.

Icon	Function	Icon	Function
	Back - Returns to the previously viewed screen. Icon is located on the left-hand edge of the toolbar.		Pause - Indicates PID data from the motorcycle is being displayed. Selecting pauses data collection.
	Home - Returns to the Home screen. Icon is located next to the Back icon on the left side of the toolbar.		Record - Indicates the data being displayed is paused and not being updated. Selecting resumes data collection.
	Save - Writes data from buffer memory to a file. The saved "movie" file can be accessed for future reference by selecting Previous Vehicles and Data > View Saved Data .		Tools - Opens the tools menu.

The icons below are used to navigate through paused or saved data ("movie") files during review.

	Step Forward - allows forward movement in singular steps. <i>(Note: To quickly step forward during Scanner data review, press and hold the icon down.)</i>		Step Back - allows backward movement in singular steps. <i>(Note: To quickly step backward during Scanner data review, press and hold the icon down.)</i>
	Skip Forward - allows forward movement in multiple steps.		Skip Back - allows backward movement in multiple steps.

3.3.5 Scroll Bar

A vertical scroll bar appears along the right-hand edge of the screen when additional data expands above or below what is currently on the screen (*Figure 3-3*).

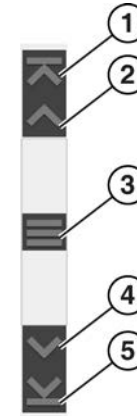

Figure 3-3 Scroll bar

- 1— **Beginning** - Moves to beginning of data displayed.
- 2— **Step up** - Moves up one increment of the data displayed.
- 3— **Slider (position indicator)** - Select and drag the **Slider** to scroll through data. The slider indicates the relative position of the current screen to the total available data.
- 4— **Step down** - Moves down one increment of the data displayed.
- 5— **End** - Moves to end of data displayed.

The Up and Down directional buttons can also be used to move through the data one line at a time. Press and hold a directional button to rapidly scroll through data.



3.4 Screen Messages

3.4.1 Snap-on Messages

Periodically messages will be displayed to inform you of software updates and upgrades, as well as other important information.

These messages require confirmation to resume tool operation. Select **Confirm** or **OK** to resume operation.

To receive messages from Snap-on, turn WiFi on, see [Wi-Fi Connection / Troubleshooting](#) on page 44.

3.4.2 General System Messages

There are four types of general system messages that may be displayed:

Message Type	Description
Loading and Connecting	Loading and connecting messages display when the diagnostic tool is performing an internal operation, such as loading a database, establishing communications with the vehicle, or initiating a test. The message automatically clears once the internal operation is complete.
Confirmation	Confirmation messages inform you when you are about to perform an action that cannot be reversed or when an action has been initiated that requires a confirmation to continue. When a response is not required, the message displays briefly, then disappears.
Warning	Warning messages inform you when completing the selected action may result in an irreversible change or in the loss of data. A confirmation is required to continue.
Error	Error messages inform you when a system or procedural error has occurred, for example if the data cable becomes disconnected during operation.

3.4.3 Vehicle Communication Messages

When “no communication” messages are displayed, it indicates the diagnostic tool and the motorcycle electronic control module(s) are not communicating.

The following conditions cause “no communication” messages to display:

- The diagnostic tool is unable to establish a communication link with the motorcycle.
- The motorcycle is not equipped with the system that was selected.
- There is a loose connection.
- There is a blown fuse.
- There is a wiring fault on the motorcycle.
- There is a circuit fault in the data cable or adapter.
- Incorrect motorcycle identification (make/model) was entered.



This section describes the basic operation of the Scanner function.



The **Scanner** icon is located on the Home screen.

The Scanner function allows your diagnostic tool to communicate with the control modules of the motorcycle being serviced. This allows you to perform tests, view diagnostic trouble codes (DTCs), and live data parameters from various vehicle systems such as the engine, antilock brakes (ABS), body control module and more.

IMPORTANT

This manual is intended to be used for P1000 motorcycle scanner operations. For automotive operations, see the Ethos Edge user manual at: <http://diagnostics.snapon.com/usermanuals>

Main Topic Links

- [Scanner Overview](#) page 10
- [Scanner Demonstration Mode](#) page 11
- [Features and Icons](#) page 12
- [Scanner - Starting / Stopping](#) page 11
- [Scanner Control Icons](#) page 12
- [Basic Scanner Operation \(Quick Start\)](#) page 13
- [Data Cable Connection](#) page 13
- [Vehicle Identification / System Selection](#) page 14
- [System Main Menu Options](#) page 16
- [Codes - View / Scan / Save](#) page 17
- [Code Scan](#) page 17
- [Viewing and Saving Data](#) page 20
- [Using Triggers](#) page 27
- [Trigger Description and Features](#) page 27
- [Functional Tests](#) page 30

4.1 Basic Operation

4.1.1 Scanner Overview

Scanner is a menu driven application that communicates with control modules to access diagnostic trouble codes (DTCs), parameter data (PIDs), functional tests, and more. To navigate the application, use your fingertip or the control buttons to make onscreen menu selections to access the desired data, test or function.

Screen messages appear when additional input is needed before proceeding. There are three types of on-screen messages; confirmations, warnings, and errors.

- **Confirmation Messages** - Confirmation messages inform you when you are about to perform an action that cannot be reversed or when an action has been initiated and your confirmation is needed to continue. When a user-response is not required to continue, the message displays briefly before automatically disappearing.
- **Warning Messages** - Warning messages inform you when completing the selected action may result in an irreversible change or loss of data.
- **Error Messages** - Error messages inform you when a system or procedural error has occurred.



4.1.2 Scanner Demonstration Mode

The Scanner demonstration mode allows you to interact with and explore Scanner functions without connecting to a motorcycle.



To use the Scanner Demonstration Mode:

1. Select **Scanner** from the Home screen.
2. Select **Demonstration** from the vehicle Make menu.

IMPORTANT

Do not connect the diagnostic tool to a motorcycle while in Demonstration Mode.

3. The simulated vehicle identification process starts. Follow the prompts to enter the motorcycle identification information and then select **OK** to confirm. The demo motorcycle is a 2017-H, CVO Limited (FLHTKSE)-TE 114 cu in. (Twin Cooled Milwaukee Eight)-F.
4. A warning message displays “Demo mode: Do not connect to vehicle.”. Select **Continue**.
5. Select a **System** (e.g. Engine, ABS, Body Control Module). The Systems menu shows all of the systems supported by the motorcycle for testing.
6. Select a **Function/Test**. Depending on which system is selected, different choices are available. Examples: Codes Menu - view trouble codes, Codes Scan - scan all systems for trouble codes, Data Display - view engine parameters (PIDs), Functional Tests - perform bi-directional tests on components.

4.1.3 Scanner - Starting / Stopping



To start the Scanner function:

1. From the Home screen, select the **Scanner** icon.
The vehicle identification process starts. The motorcycle must be correctly identified for the diagnostic tool to communicate, and display data correctly.
2. Follow the onscreen instructions to identify the motorcycle and connect the data cable. See [Vehicle Identification / System Selection](#) on page 14.

NOTE

Damage to electronic control modules may occur if communication is disrupted. Make sure the data cable is properly connected at all times during testing. Exit all tests before disconnecting the data cable or powering down the diagnostic tool.

The Scanner function remains open as long as there is an active communication link with the motorcycle. You must interrupt this communication link in order to exit from tests and power down the diagnostic tool. A warning message displays if you attempt to shut down while the diagnostic tool is communicating with the motorcycle.



To exit the Scanner function:

1. From any active Scanner screen, select the **Back** icon on the toolbar.
The “stopping communications” message briefly displays followed by the Data menu.
2. From the Data Menu, select **Back** on the toolbar.
The “stopping communications” message displays again, then the Main menu. Once the Main menu is displayed, communication has been terminated and it is safe to return to the Home screen and power down the diagnostic tool.

4.2 Features and Icons

4.2.1 Scanner Features

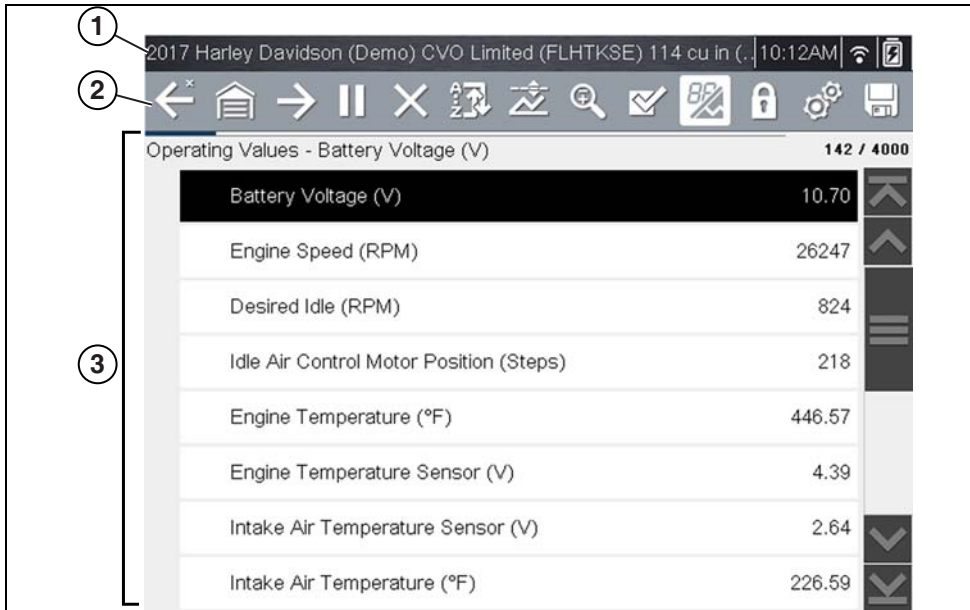

1— Title bar—shows active test, vehicle and diagnostic tool status. The Title bar appears for all functions and displays information only, there are no selectable items. See [Title Bar](#) on page 7.









2— Toolbar—contains control icons

3— Main body—displays menus, code results, PIDs, etc.

Figure 4-1 Scanner screen features

4.2.2 Scanner Control Icons

The scanner toolbar contains control icons. Control icons may vary depending on the active function or test. An inverted (highlighted) icon indicates it is selected. Other control icons (not shown) are described in [Common Toolbar Control Icons](#) on page 8.

Icon	Function	Icon	Function
	Pause - Indicates PID data from the motorcycle is being displayed. Selecting pauses data collection.		Custom Data List - Opens a menu for selecting which PIDs display in the list.
	Clear - Erases all the PID data in the buffer and begins a new recording. Selecting opens a confirmation message.		Change View - Changes display options between PID list or graph displays.
	Trigger - Opens a menu that allows you to set, arm, and clear threshold values that automatically trigger PID data to be saved from buffer memory to a file.		Lock/Unlock - Locks or unlocks the highlighted parameter. Locked PIDs move to the top of the list and do not scroll as you move through the data.
	Zoom - Incrementally increases and decreases the scale of the data being displayed.		Sort - Determines the order in which PIDs are listed on the screen.

4.2.3 Basic Scanner Operation (Quick Start)

This section lists the basic scanner operation steps, and is only intended as a quick-start reference. Refer to the supporting topics in this section for detailed operation information.

▶ Getting Started (Basic Steps)

NOTE

Menus, options and procedures will vary across motorcycle manufacturers and models.

1. Select **Scanner** from the Home screen.
2. Follow the prompts to identify the motorcycle (e.g. make, year, model), then select **OK** to confirm.
3. Follow the onscreen instructions to connect the **DA-5** data cable and **Smart Vehicle Interface (SVI)** to the motorcycle diagnostic connector. See [Data Cable Connection](#) on page 13.
4. Turn the ignition on and move the “run” switch to on, or start the engine.

NOTE

Ensure the LEDs on the SVI and DA-5 cables are on when establishing communication between the motorcycle and diagnostic tool.

5. Follow the prompts to select a **System** (e.g. Engine, ABS, Radio).
6. Select a **Function/Test** (e.g. Codes Menu, Code Scan, Data Display, Functional Tests). See [System Main Menu Options](#) on page 16.

NOTE

When the diagnostic tool is communicating with a motorcycle an icon is displayed in the title bar.

Icon	Function
	Indicates active Scanner communication (displayed in title bar)

4.2.4 Data Cable Connection

NOTE

On-screen data cable connection instructions are provided.

As an example, [Figure 4-2](#) shows a typical data cable connection using the supplied DA-5 data cable and the Harley-Davidson HAR-2 Smart Vehicle Interface (SVI), other manufacturers are similar.

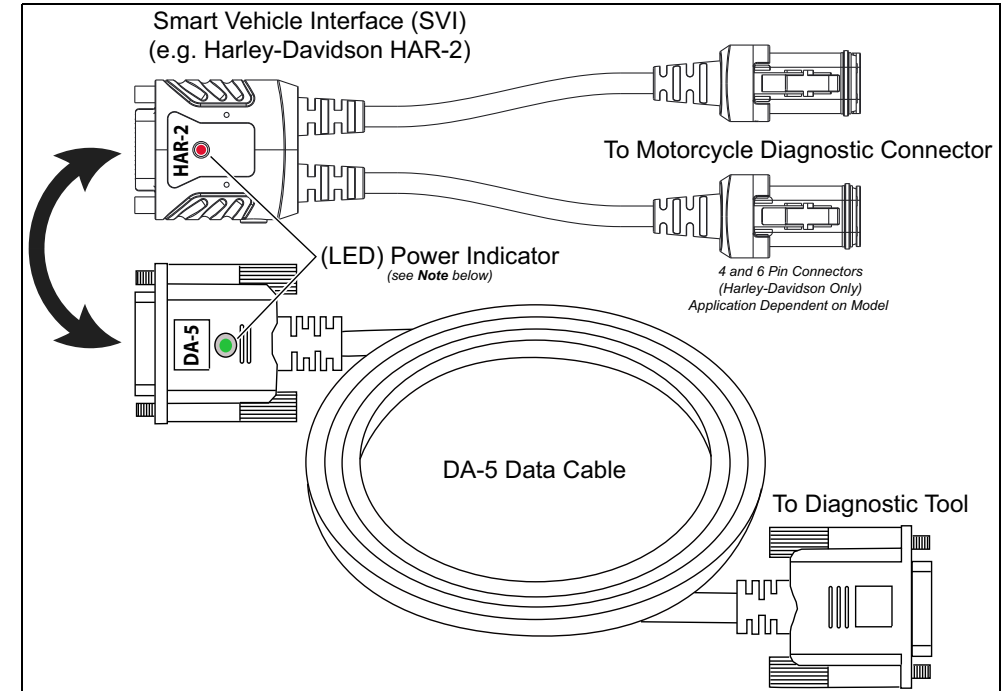

Figure 4-2

NOTE

Contact your sales representative to purchase additional Smart Vehicle Adapters (SVIs) for other Motorcycle manufacturers.

1. Follow the onscreen instructions to connect the **Smart Vehicle Interface (SVI)** to the motorcycle diagnostic connector.

**NOTE**

The SVI requires 12VDC power to communicate. Power is normally supplied through the motorcycle diagnostic connector, however the supplied 12VDC power accessory cable (not shown) can be used when power is needed. When the LED is on, the SVI is being powered.

2. Connect the **DA-5** data cable to the SVI and diagnostic tool.

NOTE

Ensure the LEDs on the SVI and DA-5 cables are on when establishing communication between the motorcycle and diagnostic tool.

4.2.5 Vehicle Identification / System Selection

The motorcycle must be correctly identified for the diagnostic tool to communicate, and display data correctly. Menus and navigation will vary by make and model.

Depending on the motorcycle, the identification process may require manual entry of the motorcycle information, or it may be automated. The following Scanner functions are available to identify the motorcycle:

Auto ID - Automatically completes the identification process after the motorcycle make and year are manually entered.

Manual ID - Allows for manual entry of all required motorcycle identification criteria.



Use the following procedure to identify a motorcycle.

NOTE

The following procedure applies to most motorcycles, and may vary depending on the motorcycle. Not all motorcycles support the Auto ID feature.

1. Select **Scanner** from the Home screen.
2. Follow the prompts to identify the motorcycle (e.g. make, year, model).

A menu option may be displayed to choose either **Automatic ID** or **Manual ID**.

- Selecting **Automatic ID** (if supported) will briefly display a communications screen informing you that the diagnostic tool is attempting to establish communication and determine vehicle identification.

Once the vehicle has been identified, the vehicle confirmation screen displays. If the vehicle information is correct, select **OK** to continue, then proceed to step 3.

If the vehicle does not support Auto ID, the diagnostic tool will attempt to identify the vehicle and then display a message indicating that vehicle identification cannot be made. If this occurs, proceed to "**Selecting Manual ID**" next.

- Selecting **Manual ID** allows you to manually enter all the vehicle information to identify the vehicle.

Follow the screen prompts to enter all the information required to identify the vehicle. Once the vehicle has been identified, the vehicle confirmation screen displays (*Figure 4-3*). If the vehicle information is correct, select **OK** to continue, then proceed to step 3.

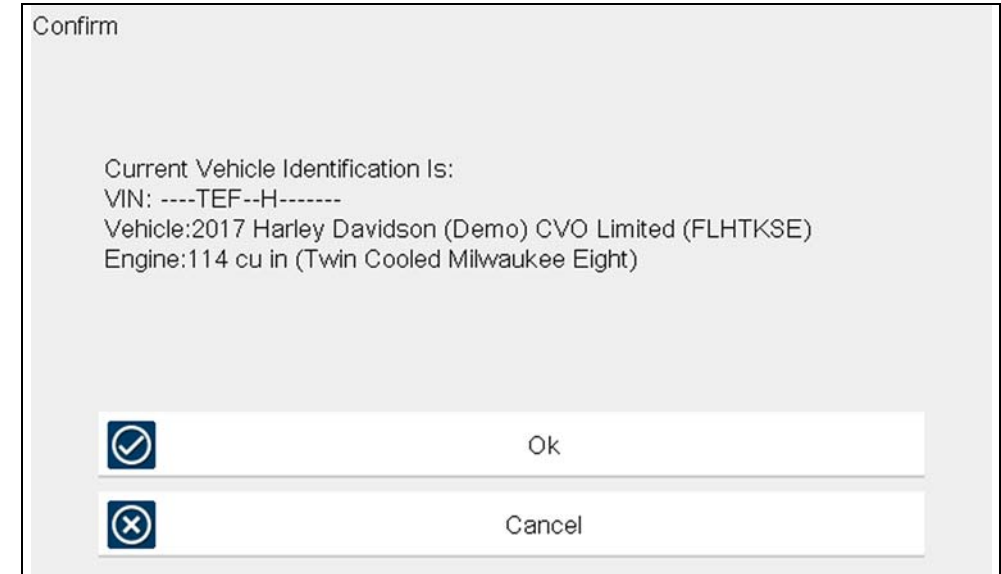

Figure 4-3 confirmation screen

After the motorcycle is identified, prompts will indicate to turn the motorcycle ignition on and connect the data cable.

Depending on the motorcycle, a menu option to select a system list display type may be provided ([Figure 4-4](#)).

Some motorcycles may support a “Fitted Systems” display type. In this situation a menu option is provided to display the fitted systems or all systems. Selecting Fitted Systems will only display systems that the diagnostic tool is communicating with. Selecting All Systems will display every system possibly supported.

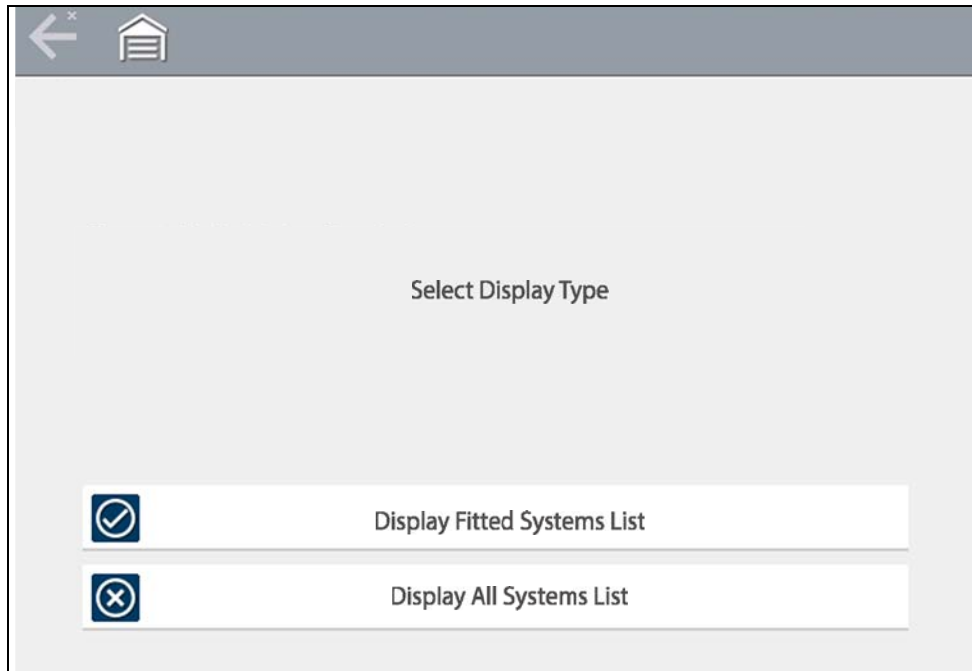

Figure 4-4

3. A menu of available systems and/or options is displayed. Select a system or option ([Figure 4-5](#)) to continue.

By default, System options are displayed by category (e.g. Audio/Video, Body Controls, Instruments, etc.). In this mode commonly used selections are at the top of the list.

Depending on your preference, select the icon ([arrow in Figure 4-5](#)) to toggle the display between a categorized ([Figure 4-5](#)) and non-categorized ([Figure 4-6](#)) list.

When a system (e.g. Engine, Antilock Brakes, etc) is selected, the diagnostic tool will attempt to establish communication with that motorcycle system, then (once connected) will display that system’s main menu, see [System Main Menu Options](#) on page 16.

For Code Scan information, see [Code Scan](#) on page 17.

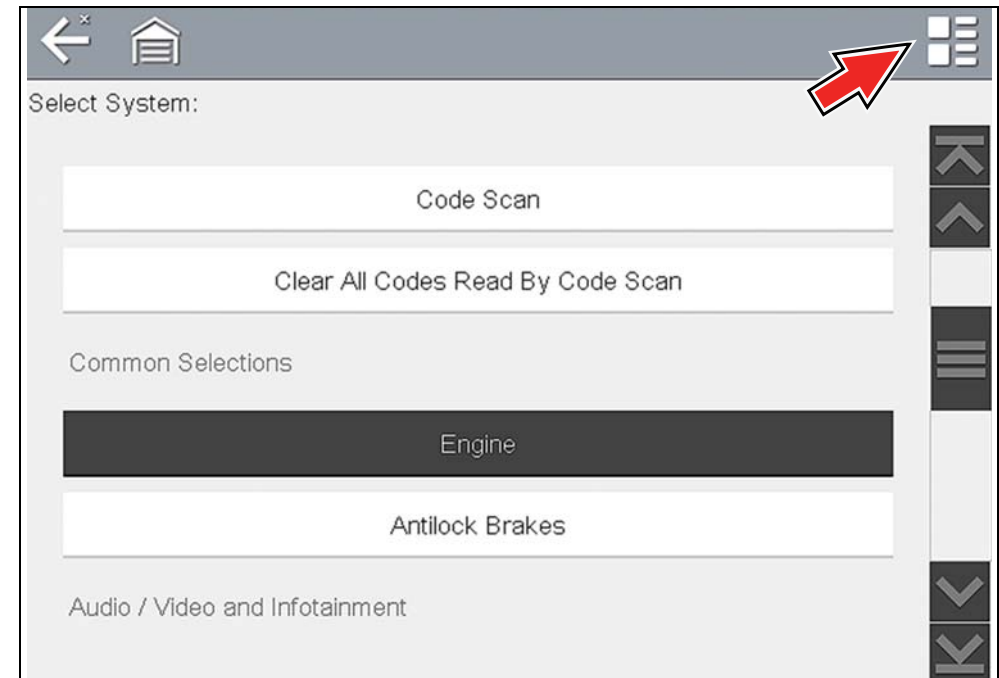

Figure 4-5 Typical systems menu (categorized list view)

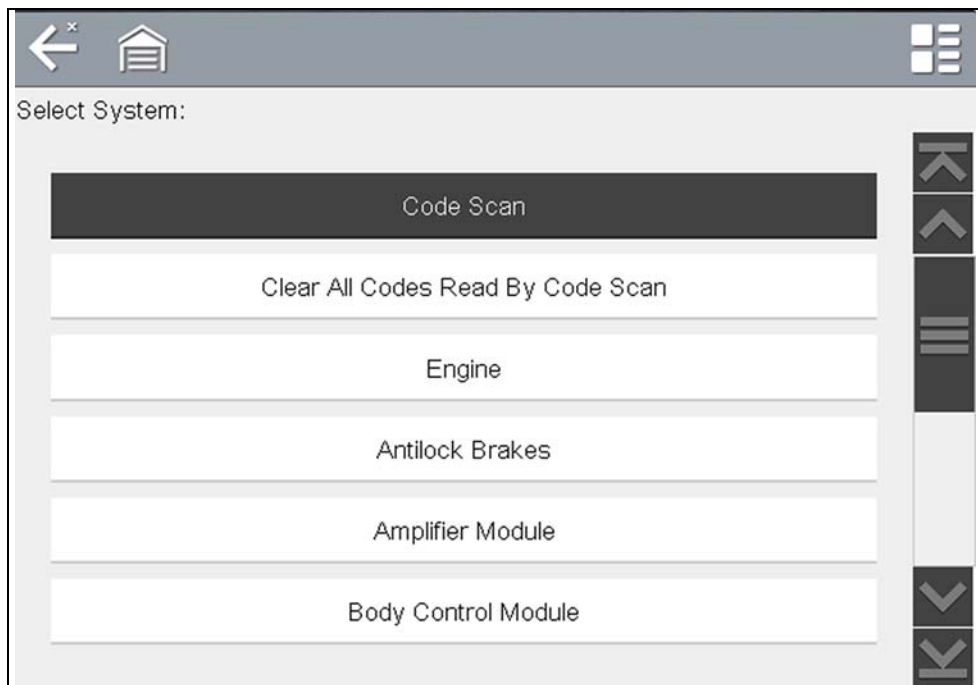

Figure 4-6 Typical systems menu (non-categorized list view)

4.3 System Main Menu Options

Once a System is selected (e.g. Engine, Antilock Brakes, etc) is selected, the diagnostic tool will attempt to establish communication with the motorcycle, then (once connected) will display ([Figure 4-7](#)) the system main menu (available tests).

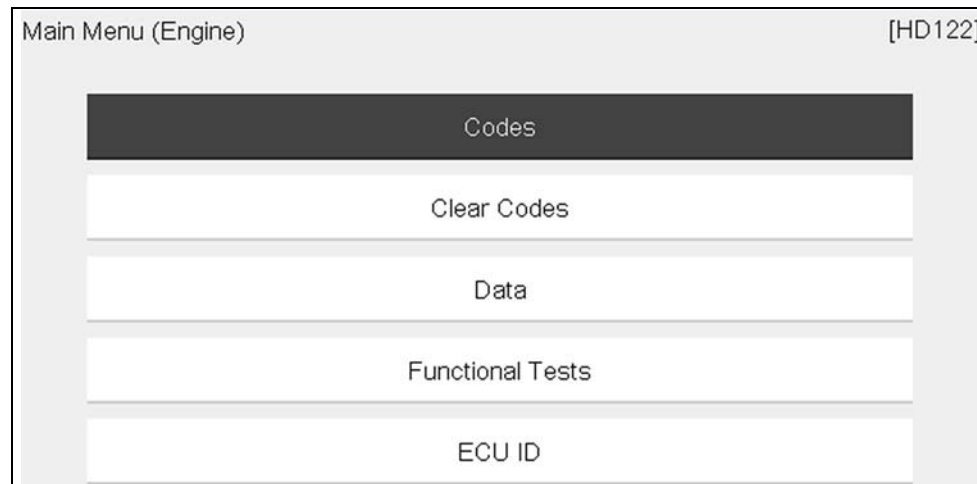

Figure 4-7 Typical (Engine) main menu

- Menus and navigation will vary by motorcycle make and model.

The System Main Menu may include these typical selections:

- **Codes**—displays diagnostic trouble code (DTC) records from the control modules. Selecting may open a submenu of viewing options. See [Viewing Codes on page 17](#).
- **Clear Codes**—erases DTC records and other data from the ECM. This selection is found on a Codes submenu for some models. See [Clear Codes on page 17](#).
- **Data**—displays PID data from the control modules. Selecting may open a submenu of viewing options. See [Viewing and Saving Data on page 20](#).
- **Functional Tests**—provides specific subsystem tests. The tests vary depending on the manufacturer and model. See [Functional Tests on page 30](#).
- **ECU ID**—provides specific ECU information for the selected module.

4.4 Codes - View / Scan / Save

4.4.1 Viewing Codes

After selecting a System, “Codes” may appear as a menu selection (*Figure 4-7*) from the Main System Menu. Depending on the motorcycle manufacturer, a different name may be used (e.g. Codes Menu, Codes Only, Codes (No Data), Service Codes, etc).

Selecting this function opens a list of diagnostic trouble codes (DTCs) stored in the selected control module. The code list includes the DTC and a brief description (*Figure 4-8*).

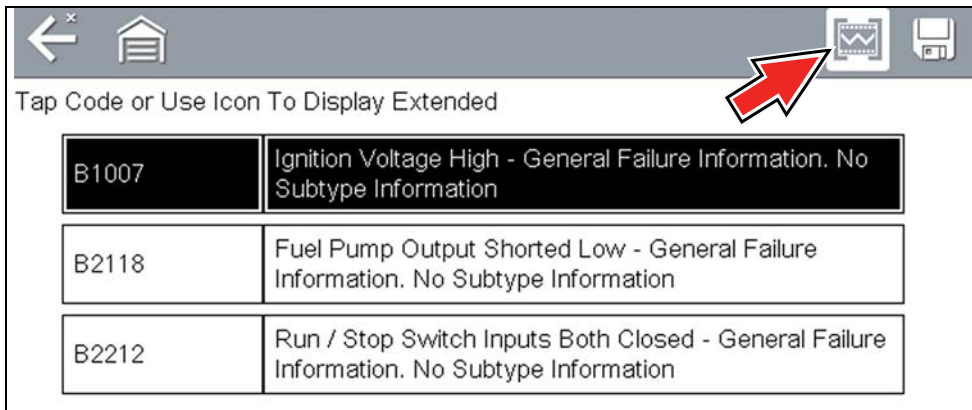

Figure 4-8 DTC results

Select the code or the Extended DTC Data icon (*Figure 4-8*) for additional information. The Extended DTC Data icon only displays if the motorcycle supports this feature and information is available.

Extended DTC Data may include:

- Odometer Mileage
- Occurrence
- Trips Since First Failure
- Trips Since Last Failure

4.4.2 Clear Codes

The diagnostic tool can clear codes from the electronic control module(s). This selection only displays if the motorcycle supports this feature.



To clear codes:

1. Select **Clear Codes** from the Codes Menu.
A confirmation message displays.
2. Make sure any conditions shown on the confirmation message are met, then select **Yes**.
A “codes cleared” message displays once the operation is complete.
3. Select **Continue** to return to the Codes Menu.

IMPORTANT

Clearing codes erases all temporary ECM information. Make sure no vital diagnostic information will be lost before clearing codes.

4.4.3 Code Scan

Code Scan is available from the Main System Menu, and when selected it scans the control modules for codes. The results of the scan are configured into a report that is accessible and printable using ShopStream Connect™. The report can be printed, downloaded, attached to an e-mail or other social media app to share with others. For additional information on using ShopStream Connect, see [ShopStream Connect™ on page 50](#).

IMPORTANT

PRE / POST Scan Importance - As many systems do not turn on the check engine light or other indicator, performing a code scan before making any repairs may help in troubleshooting, by identifying possible unknown issues that may be related to the present symptoms.

Performing pre and post scans also allows you to record in report format the pre-condition of the vehicle and compare the post scan after work is complete to confirm the repairs were completed properly.

NOTES

The Code Scan function and results are dependent upon the vehicle. Not all vehicles may support this function.

Selecting **Code Scan** from the Vehicle System menu (*Figure 4-9*) starts an active scan of vehicle control modules, and opens the Code Scan results screen (*Figure 4-10*).



Figure 4-9 Code Scan

When initially started, progress status is shown at the top indicating the active scanning progress. Once completed, code results are displayed by system.

The following are displayed as the modules are scanned and are described in the following sections.

- [Code Scan Toolbar](#)
- [Total Number of Systems \(modules\) Analyzed](#)
- [List of All the Systems Analyzed with DTCs Totals](#)

Code Scan Toolbar

The following Code Scan related control icons are used:

Icon	Function
	Refresh - Refreshes the code scan data (restarts the code scan)
	System - Opens the main menu of the system selected (highlighted)
	Save - Saves the code scan results as an (.XML) file. See Viewing Codes and Code Scan Results on page 33.

Total Number of Systems (modules) Analyzed

The total number of systems analyzed is actively displayed at the top of the screen as they are scanned.

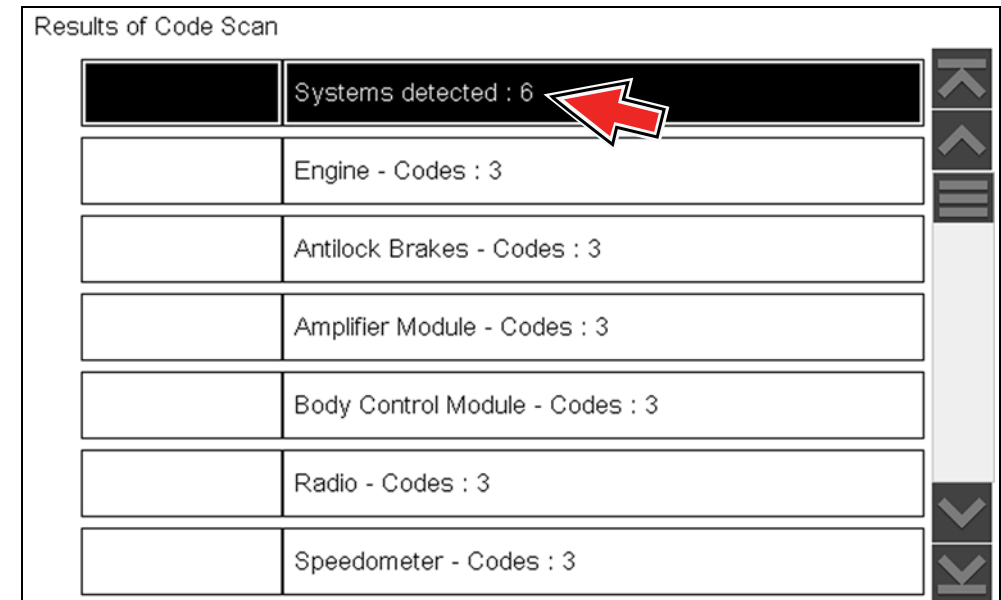

Figure 4-10 Code Scan systems analyzed result total

List of All the Systems Analyzed with DTCs Totals

A categorized system list with DTC totals is displayed in the order they are scanned. To view the main menu for a system in the list, select the system, then select the **System** icon (Figure 4-11).

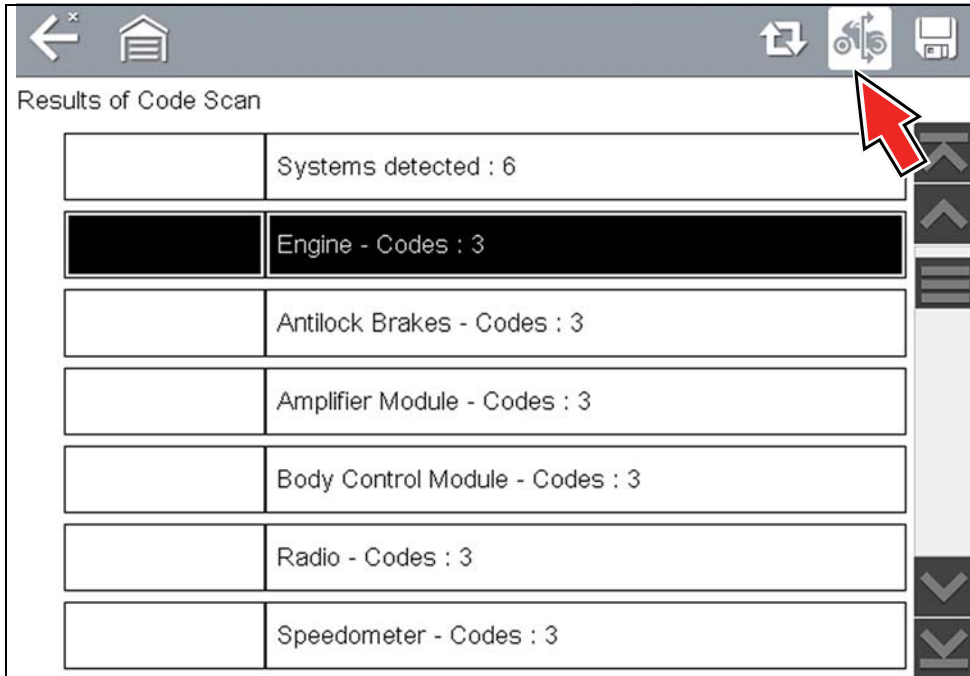

Figure 4-11 System icon (opens Main Menu)

Saving Codes and Code Scan Results

Icon	Function
	Save - Saves the displayed code list results as an (.XML) file.

When using the code scan feature, or when viewing individual system codes (e.g. engine, antilock brakes) selecting the **Save** icon from the toolbar saves the results as a report formatted file.

To manually save the code scan report:

1. Perform a code scan.
2. After the code scan has completed, select **Save**.
A confirmation message is displayed indicating that the file was saved.

Message Example: "Saving A2810005.XML"

The saved file(s) can be viewed on the diagnostic tool - See [Viewing Codes and Code Scan Reports on the Diagnostic Tool](#) on page 33.

Printing Codes and Code Scan Results

The code scan report and saved codes can be printed using ShopStream Connect - See [Printing the Code Scan Report](#) on page 53.

Clear All Codes Read by Code Scan

Selecting **Clear All Codes Read by Code Scan** erases all DTCs from all vehicle system modules that were read by Code Scan.

4.5 Viewing and Saving Data

Selecting **Data** or other similar data menu option (depending on the vehicle manufacturer) displays PID data for the selected system (*Figure 4-12*).

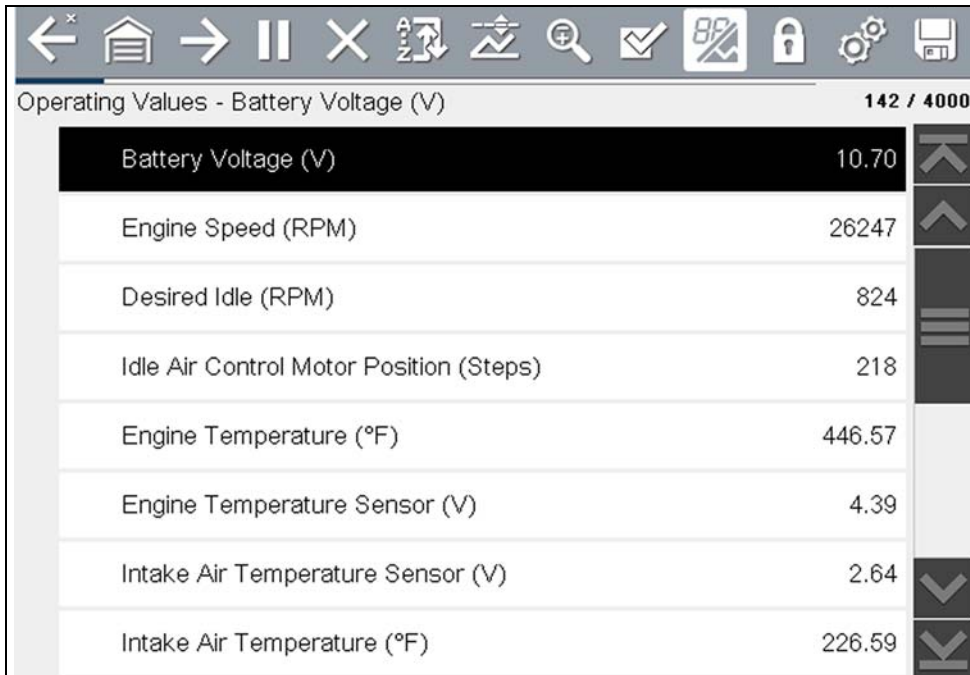

Figure 4-12 Data display (PID List view)

During data display the main body of the screen is divided into two columns; the left-hand column has a description of the parameter and the right-hand column shows the current parameter value or state. PIDs are listed in the order in which they are transmitted by the ECM, so variations between years, makes, and models will occur.

The toolbar control icons are described in *Scanner Control Icons* on page 12 and *Common Toolbar Control Icons* on page 8.

4.5.1 About the Data Buffer

The diagnostic tool has the capability to collect, store and save PID data utilizing internal storage memory and buffer memory.

When Data is displayed onscreen, a data buffer automatically starts to store it in buffer memory. The data buffer runs continuously (storing data) until the Pause, Clear, or Save icon is selected.

Buffer memory is limited to a predetermined “total” size. When buffer memory reaches it’s full capacity, the data buffer will continue to store new data, however earlier stored data will be removed to allow room for the new data being stored.

The most recent data is always available for review when Pause is pressed, and can be reviewed using the toolbar controls.

The Data Buffer Indicator (*Figure 4-13* left arrow) can be used to visually see the amount of stored buffer data. This graphical indicator uses a bar graph to show how much stored data is in the memory buffer.



Figure 4-13

The Data Buffer Position Counter (*Figure 4-13* right arrow) indicates:

- first value = the numerical position of the current frame of data (displayed) within buffer memory
- second value = indicates the maximum data buffer size value (e.g. 4000)

During data review (*Figure 4-14*), a slider on the bar graph indicates the position of the current frame of data (displayed) in relation to the entire memory buffer contents.



Figure 4-14



4.5.2 About Cursors

Vertical cursors are automatically displayed (in graphical PID views) to mark specific data reference points.

Gray (Pause/Save) - If you select Pause or Save while collecting data, a vertical gray cursor is automatically placed at that point in the data to indicate where the data was paused or saved.

- Each time Pause is pressed an additional cursor is added, and appears when Record is pressed to resume data collection.
- Each time Save is pressed an additional cursor is added, and appears when the data starts again after a slight pause to save the file.
- Cursors are displayed in all PIDs as reference markers.
- Cursors are retained and appear in saved data files.

Blue (Current Position) - If you select Pause while collecting data, a vertical blue cursor is displayed as an indicator to your position in the data and is denoted by the current position value in the counter display.

- Cursors are displayed in all PIDs as reference markers.
- Depending on the amount of data saved the blue cursor may be initially located on the far left next to the description, or the far right next to the scroll bar making it difficult to see. If this happens, use the control icons (Step/Skip) to move the data until you can see the cursor.

Red (Triggered PID Activation Point) - When using triggers, a vertical red cursor is displayed in the data of the triggered PID at the point where the trigger was activated.

- When multiple PIDs are armed, only the PID that is triggered first will display a red cursor.

Green (Trigger Activation Reference Point) - When using triggers, green vertical cursors are displayed in all PIDs (except the PID that was triggered) as reference to the triggered PID activation point.

- When a trigger is activated the displayed red and green cursors are all vertically aligned in the graphed data to show the relationship of the trigger point in all PIDs.

4.5.3 Pausing and Reviewing Active Data

During normal operation, data from the vehicle's ECM is continuously being stored in buffer memory as it is displayed onscreen. The Pause icon, allows you to temporarily pause data collection to review it in detail.

 **To pause and review active data:**

While collecting data, select the **Pause** icon ([Figure 4-15](#)).

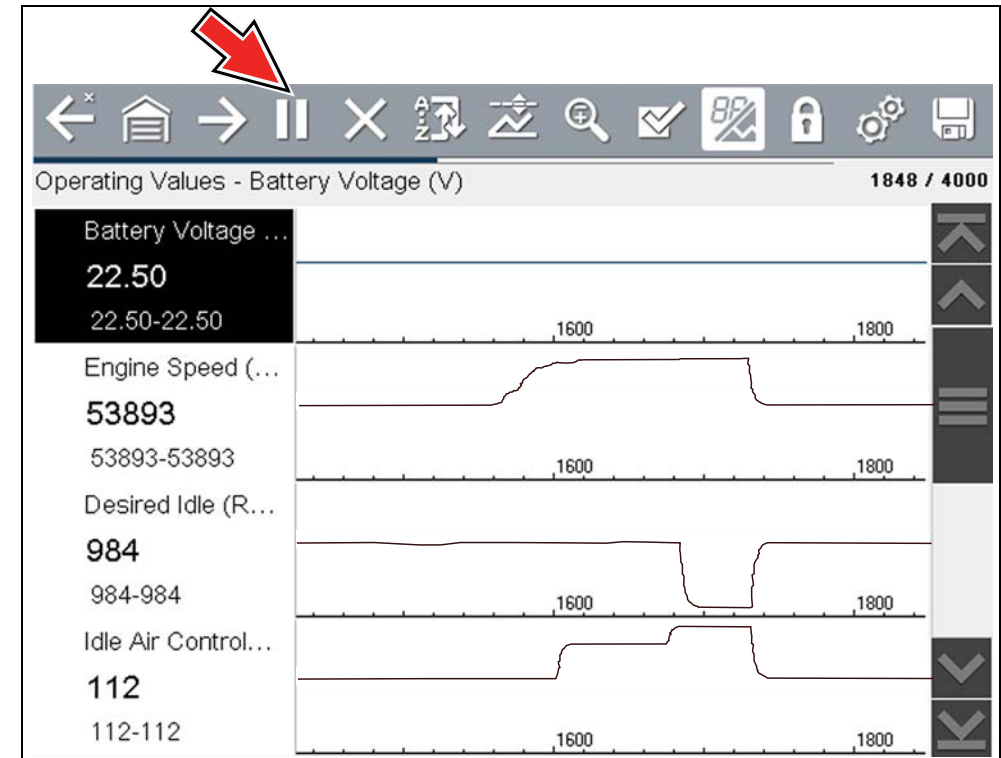

Figure 4-15

Toolbar control icons are described in [Scanner Control Icons](#) on page 12 and [Common Toolbar Control Icons](#) on page 8.

After Pause is pressed:

- Review control icons are displayed in the toolbar ([Figure 4-16](#)). Use the control icons to accurately move through the data and position the blue cursor.
- The blue (vertical cursor) ([Figure 4-16](#)) indicates your position in the data and is denoted by the current position value in the counter display. This cursor displays in all PIDs.

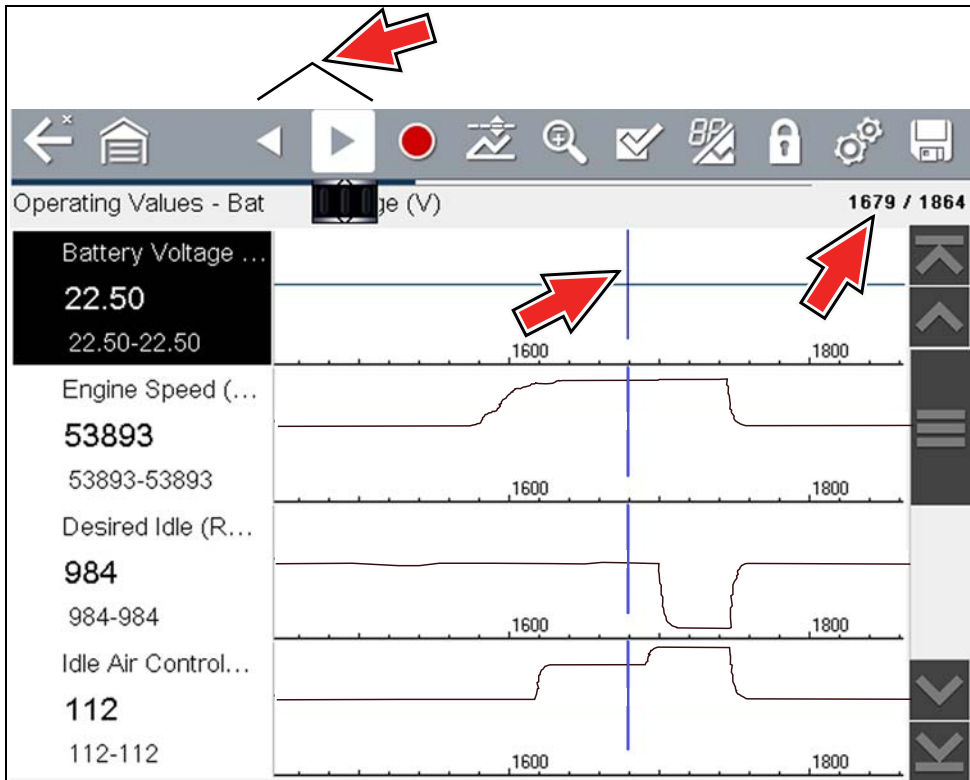

Figure 4-16

NOTE

The **Shortcut** icon can be set to perform the Pause/Play function. See [Configure Shortcut Button](#) on page 37 for additional information.

To resume data collection (after pausing):

- Select the **Record** icon .

The screen changes back to display data ([Figure 4-17](#)).

A vertical gray cursor is displayed on all PIDs, indicating where the data was paused ([Figure 4-17](#)).

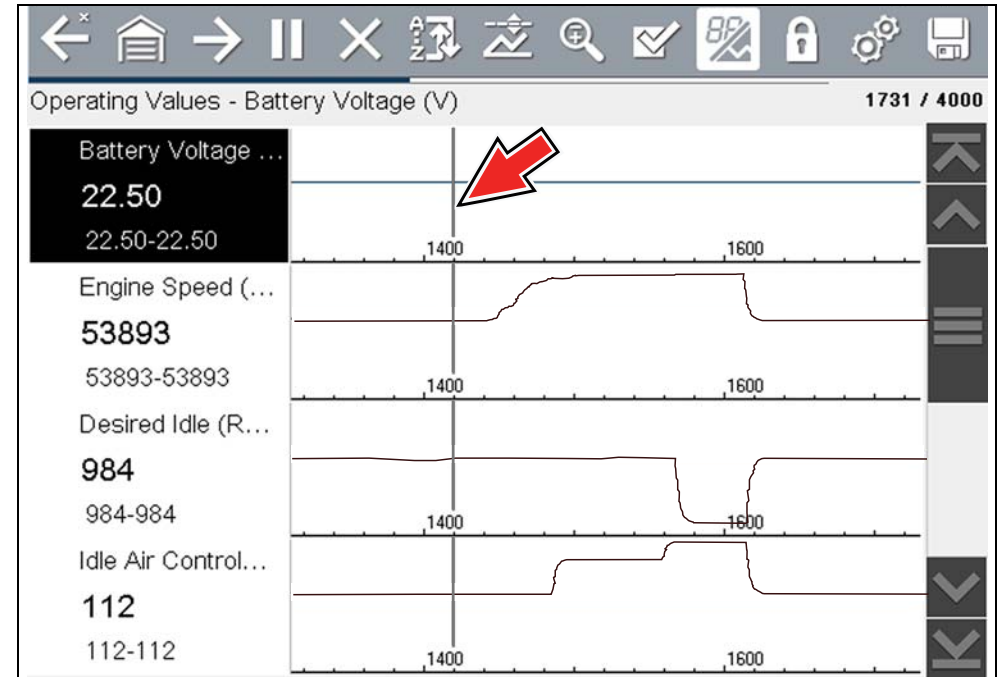

Figure 4-17

4.5.4 Saving Data Files

Saving data is useful when trying to isolate an intermittent problem or to verify a repair. During normal operation, data from the vehicle's ECM is continuously being stored in buffer memory as it is displayed onscreen. Selecting **Save** writes stored buffer memory to a file.

NOTE

The **Save icon** performs the same function as "Save Movie" function choice for the programmable **Shortcut button**, see [Configure Shortcut Button](#) on page 37 for details.

To save data:

While capturing or reviewing data, select the **Save** icon.

An onscreen message is displayed to indicate the data file is being saved ([Figure 4-18](#)).

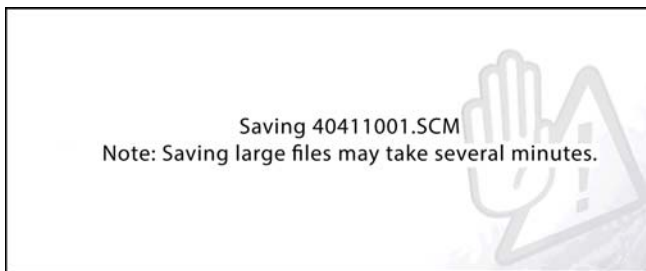

Figure 4-18 Save dialog box

To view saved data (on the diagnostic tool):

The saved file can be viewed by selecting **Previous Vehicles and Data > View Saved Data**. See [View Saved Data](#) on page 33 for basic navigation.

1. Select the desired data file (.SCM file extension).
2. Change the view type and zoom levels as needed.
3. In graph view, use the control icons to move through the data ([Figure 4-19](#)).

Toolbar control icons are described in [Scanner Control Icons](#) on page 12 and [Common Toolbar Control Icons](#) on page 8.

The blue (vertical cursor) ([Figure 4-19](#)) indicates your position in the data and is denoted by the current position value ([Figure 4-19](#)) in the counter display. The cursor displays in all PIDs.

Depending on the amount of data saved the cursor may be initially located on the far left next to the description, or the far right next to the scroll bar making it difficult to see. If this happens, use the control icons to move the data until you can see the cursor.

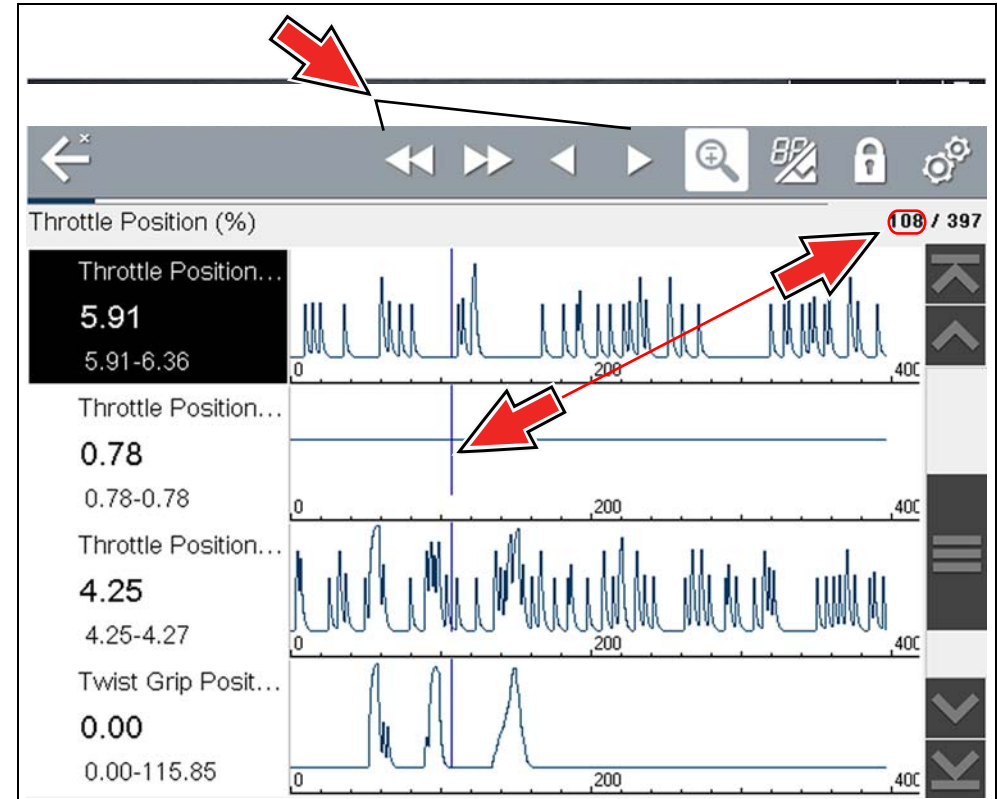

Figure 4-19

Pressing the Save icon more than once in the same data collection session will create multiple (.SCM) files. Each file will contain gray (vertical cursors) ([Figure 4-19](#)) indicating where the data was paused.

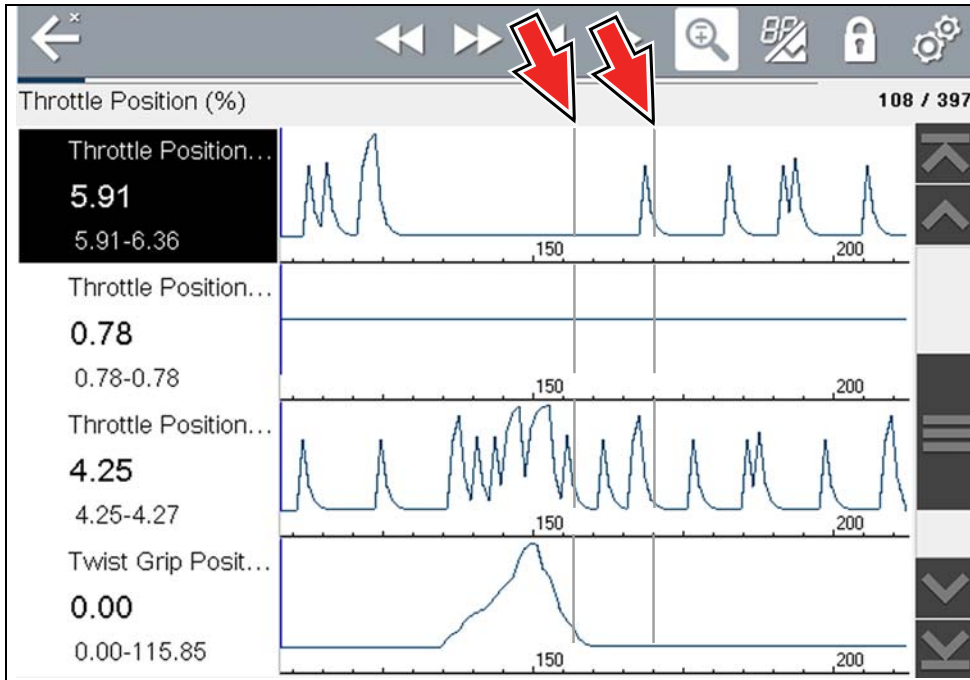

Figure 4-20

▶ To view saved data (on a PC)

Saved data files can also be downloaded to a personal computer (PC) using the Mini USB jack. Once connected to the PC, the data files can be printed, transferred, and copied using ShopStream Connect. ShopStream Connect is an application that creates an interface between the diagnostic tool and a PC. The ShopStream Connect application is available free online, see [ShopStream Connect™](#) on page 50.

4.5.5 Using Zoom



The zoom function allows you to change the magnification level of the graphed data during data collection and review. Changing magnification levels allows you to compress or expand the displayed data to quickly find glitches, or signal losses.

When the **Zoom** icon is selected the dropdown menu allows you to select the display magnification level from a range of -2X to +8X. The "Zoom Out" option displays up to half of the maximum amount of data that can be collected, on one screen. The default magnification level is 1x.

Examples: Top (+4X), Middle (1X), Bottom (Zoom Out)

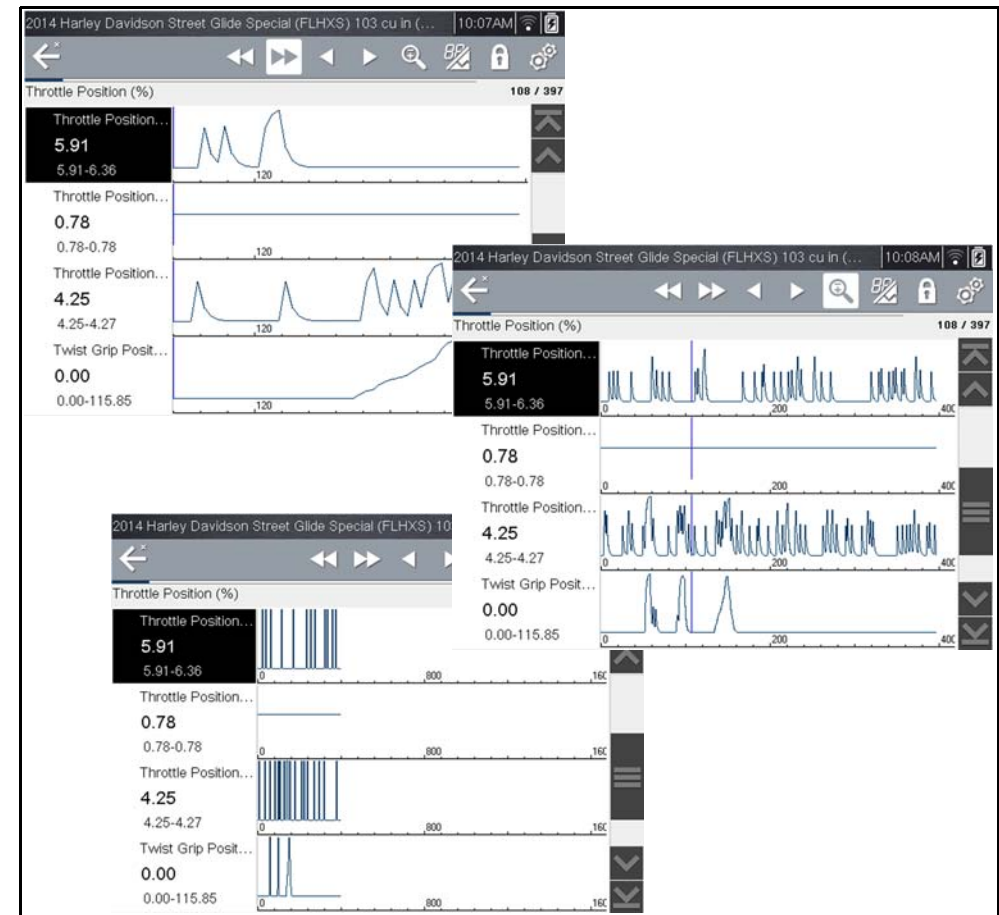

Figure 4-21 Zoom examples

4.5.6 Changing Data Views - PID List / Graphs



Selecting the **View** icon ([Figure 4-22](#)) opens a drop-down menu of viewing options:

- PID List
- 1 Graph
- 2 Graphs
- 4 Graphs

The PID List view is a 2-column display with the name of the parameters in the left column and their current values in the right column ([Figure 4-22](#)).

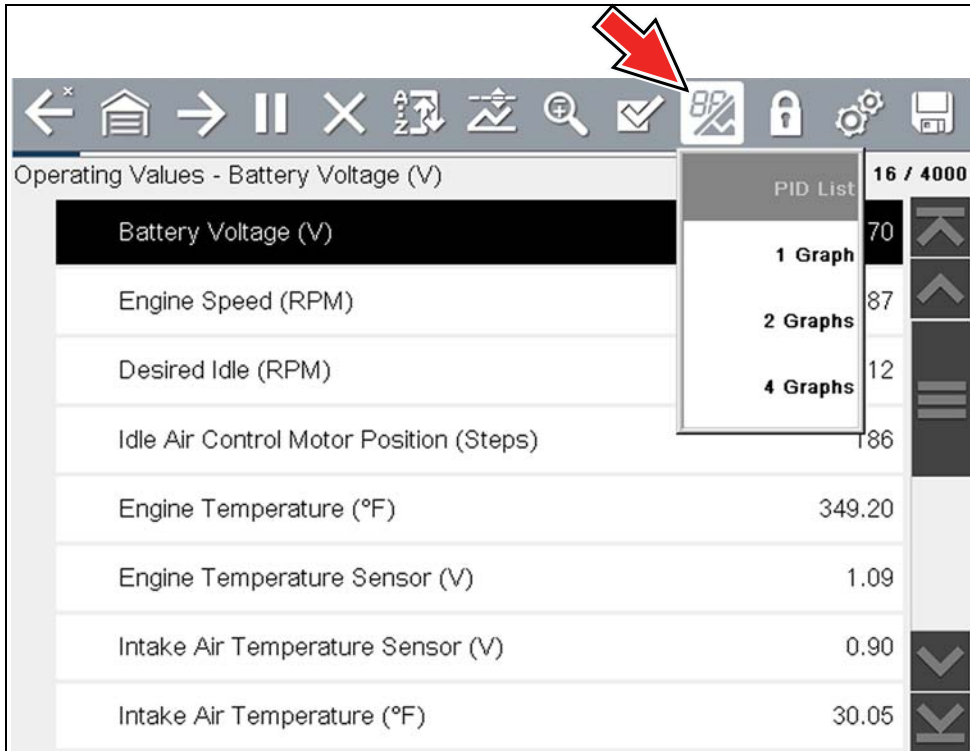

Figure 4-22 PID List view

The 1, 2, and 4 Graph views divide the screen horizontally to simultaneously display data graphs for the indicated number of parameters ([Figure 4-23](#)).

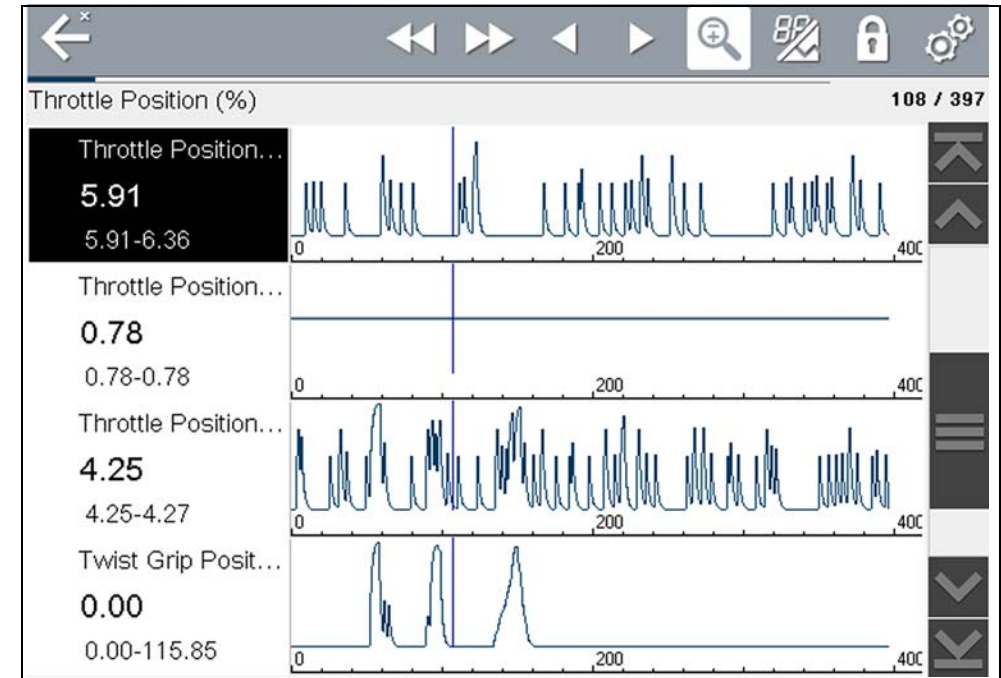

Figure 4-23 Four graph view

In graph view the text block ([Figure 4-24](#)) to the left of the graph displays:

- Top - PID description
- Middle - Current value or state
- Bottom - Active minimum and maximum values

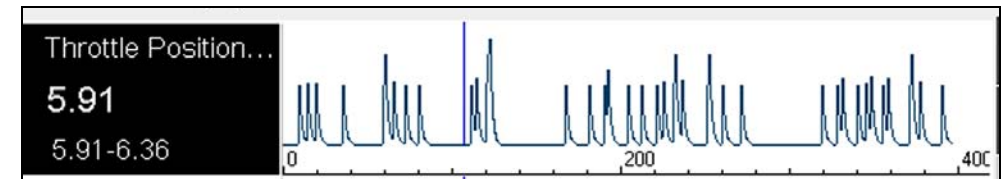

Figure 4-24

4.5.7 Selecting PIDs to Display (custom display)



The **Custom Data List** icon on the toolbar is used to select which PIDs to display. Minimizing the number of PIDs displayed allows you to focus on any suspicious or symptom-specific data parameters. You can add or remove most PIDs from the list, as certain vital PIDs may not be removed. These appear in gray at the top of the list along with a lock icon, and they cannot be selected.

NOTE

Limiting the number of parameters that display to those that apply to a particular situation results in a faster data refresh rate, and reduces the amount of memory used for saved files.



To create a custom data list:

1. Select the **Custom Data List** icon on the toolbar.

The data selection screen displays ([Figure 4-25](#)) and selection icons appear. Check marks to the left of the parameter description indicate which parameters are selected for display.

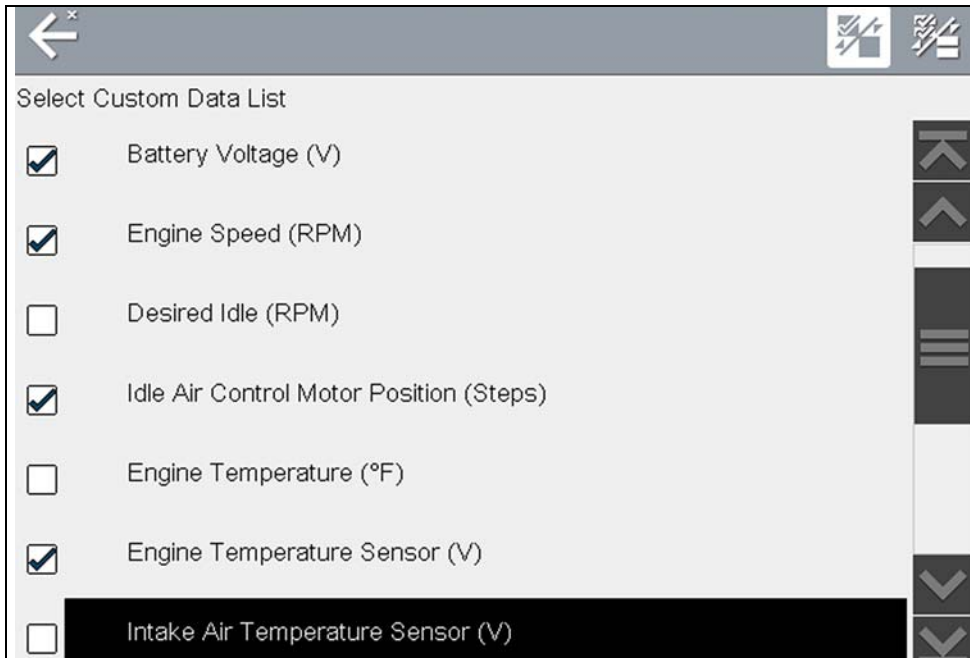

Figure 4-25 Data custom PID selection

The toolbar icons provide options for selecting and deselecting parameters to include or remove from the custom data list:

Icon	Description
	Select/Deselect - hide or display individual PIDs in the list
	Select All/Deselect All - hide or display all PIDs in the list.

2. Create a custom data list by selecting (check mark) the parameters to include.
3. Select **Back** to display the updated data list.

4.5.8 Locking PIDs (to always display at top)



Use the **Lock/Unlock** icon to hold selected lines of the data in place and prevent them from scrolling, or to release previously locked lines of data. Up to three lines of data may be held at a time. This feature allows you to position related parameters together, making it easier to monitor their values and spot inconsistencies.

Locked parameters display as the top frames on the main body of the display screen, as well as at their usual position within the data list ([Figure 4-26](#)). A lock icon appears to the left of the parameter name to indicate it is locked.



To lock parameters:

1. Highlight the parameter to be locked.
2. Select the **Lock/Unlock** icon on the toolbar to lock it.
A copy of the locked parameter is now shown at the top of the data list, and a lock icon appears alongside the parameter name.
3. Highlight and select additional parameters to lock.

Up to three parameters can be locked at a time. Once locked, a parameter remains locked until it is manually unlocked, or communication with the vehicle is stopped.

Operating Values - Battery Voltage (V)		176 / 4000
Locked	Battery Voltage (V)	7.70
Locked	Engine Speed (RPM)	15187
Locked	Idle Air Control Motor Position (Steps)	186
	Battery Voltage (V)	7.70
	Engine Speed (RPM)	15187
	Desired Idle (RPM)	1112
	Idle Air Control Motor Position (Steps)	186
	Engine Temperature (°F)	349.20

Figure 4-26 Locked parameters

NOTE

If three parameters are locked, one of them must first be unlocked before another parameter can be locked.

- To unlock parameters:**
1. Scroll through the data list and highlight the parameter to be unlocked, or released.
 2. Select the **Lock/Unlock** icon on the toolbar.
The released parameter and the lock icon disappear from the list at the top of the data list.
 3. Repeat Step 1 and Step 2 to release other parameters if needed.

4.5.9 Using Triggers

Trigger Description and Features



Setting PID triggers allows you to configure the diagnostic tool to automatically save PID data to a file, when a PID value meets an upper/lower limit (trigger point).

When a PID value meets the trigger point it activates the trigger which captures a short recording of all available PID data and saves it as a data file.

You can review the saved data file to closely evaluate not only the PID that triggered the event, but all the PIDs being monitored to collectively see what was happening at the time of the event.

Examples of the following trigger states (Armed / Not Activated - upper image) and (Activated - lower image) are shown in ([Figure 4-27](#)).

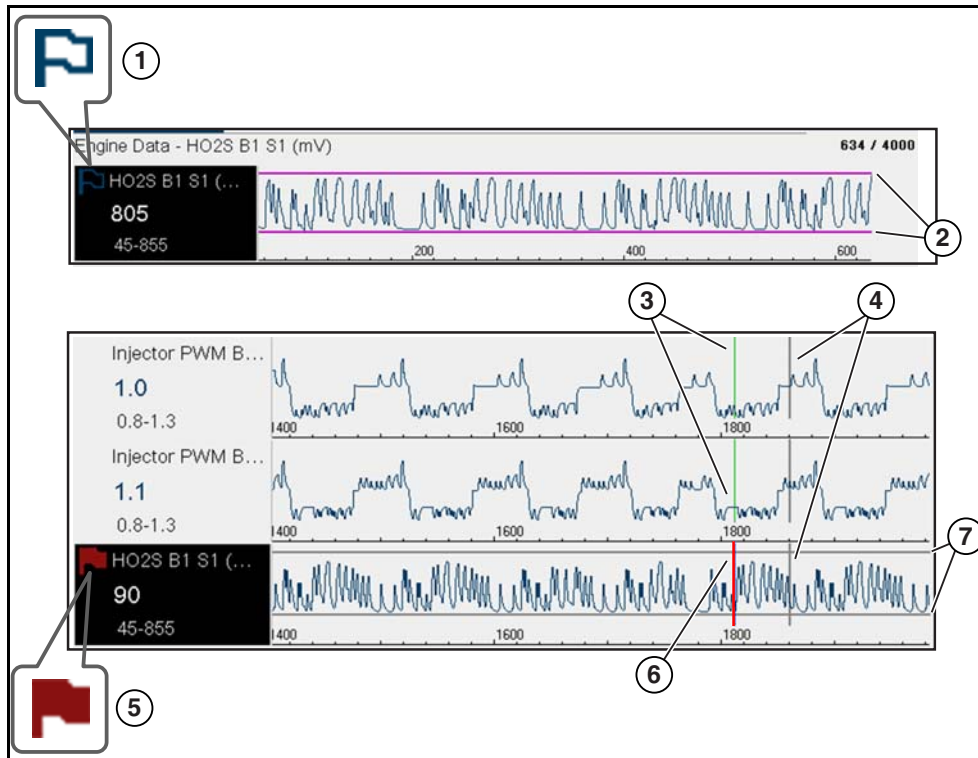

Figure 4-27

- 1— **Armed PID Trigger Indicator** - A blue outlined flag indicates the PID trigger is armed.
- 2— **Upper and Lower Limit Lines (Armed)** - Colored limit lines indicate the trigger is armed but not activated.
- 3— **Trigger Activation Point Reference Cursor** - Green cursors lines are displayed on all the other PID graphs to indicate their relationship to where the trigger occurred.
- 4— **Pause Cursor** - A vertical gray cursor line is displayed (all PIDs) as a marker in the where the data was paused and the file was saved.
- 5— **Activated PID Trigger Indicator** - A red flag indicates the PID trigger has activated.
- 6— **Trigger Activation Point Cursor** - A red cursor line is displayed in the PID data where the trigger was activated.
- 7— **Upper and Lower Limit Lines (Not Armed and Activated)** - Gray limit lines are displayed when the trigger is armed but not activated and after the trigger has been activated.

▶ Setting triggers:

To use triggers, they must be turned on (set/configured), and then armed. Use the following procedures to setup PID triggers.

1. Highlight the PID to setup with a trigger.
2. Select the **Trigger** icon.

Selecting the **Trigger** icon (*Figure 4-28*) displays trigger menu options:

- **Set Trigger**—opens setup screen for upper/lower limits (trigger points)
- **Arm Trigger**—arms the trigger to capture data
- **Clear All Triggers**—deletes all previously set triggers

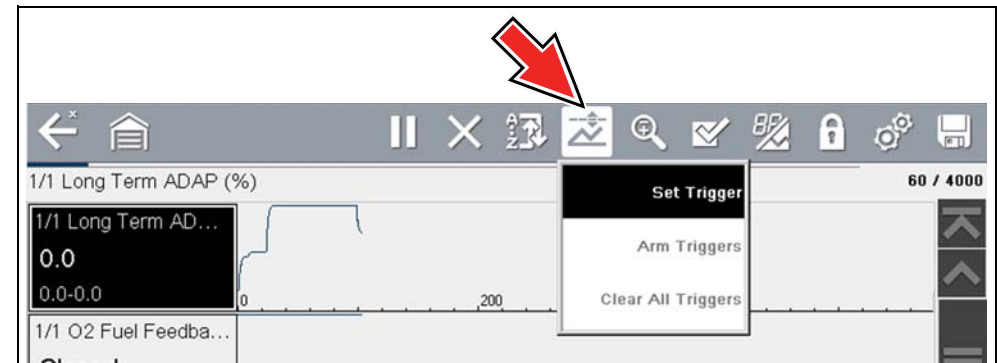

Figure 4-28 Trigger menu

If triggers are already set, the menu options are:

- **Clear Trigger**—deletes the highlighted trigger
- **Disarm Trigger**—disarms the highlighted trigger
- **Clear All Triggers**—deletes all set triggers

3. Select **Set Trigger**.

A graph of the highlighted PID and setup icons display (*Figure 4-29*).

The upper trigger point must be set first. A red horizontal line is displayed across the data graph (*Figure 4-29*) representing the upper trigger point.

4. Use the plus (+) and minus (-) icons (*Figure 4-29*), or the up ▲ and down ▼ arrow buttons to change the position of the upper trigger point.
5. Select ✓, or press the Y/✓ button, to set the upper trigger point.

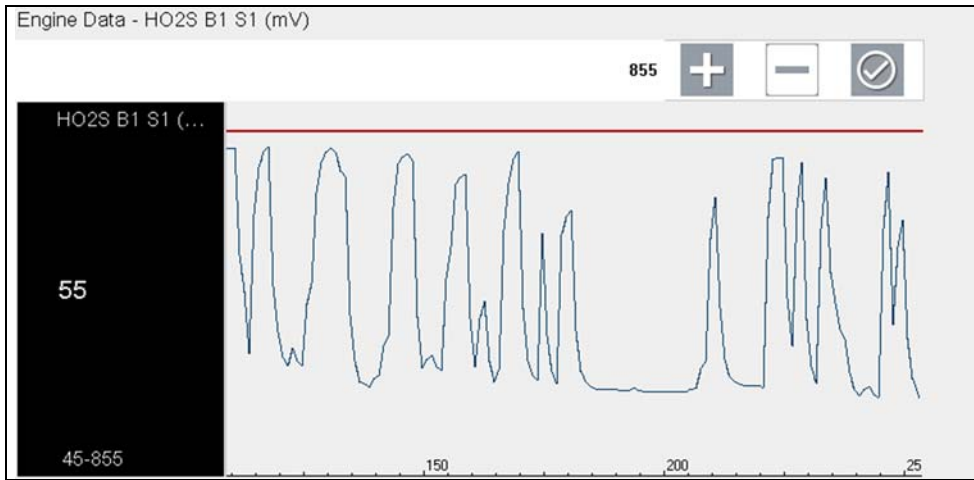

Figure 4-29 Trigger setup - upper limit

The upper trigger line changes color to gray and the lower trigger line displays in red (Figure 4-30).

6. Change the position of the lower trigger line in the same manner as the upper.
7. When finished, select ✓, or press the **Y/✓** button, to set the lower trigger level.

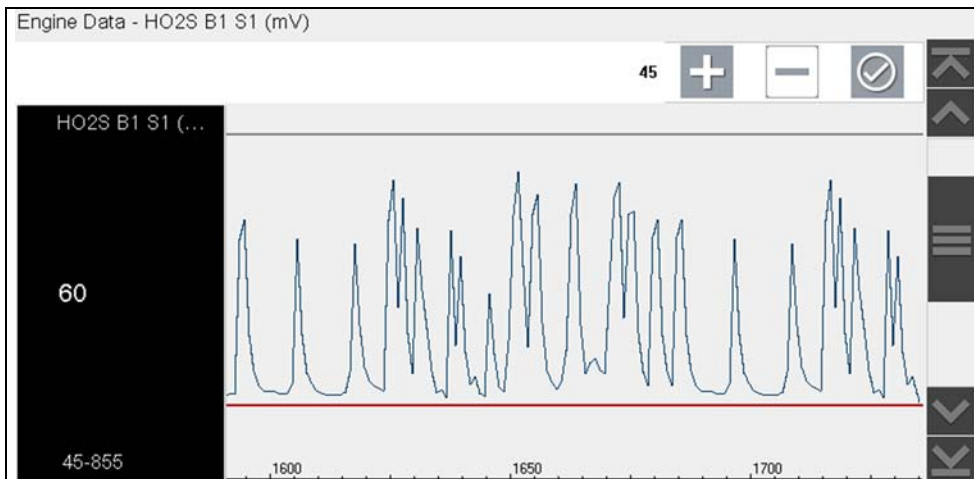

Figure 4-30 Trigger setup - lower limit

The display returns to the PID data view and the trigger points appear as horizontal lines across the designated graph (Figure 4-31). Repeat this procedure to establish trigger points for other parameters (up to three) if desired.

NOTE

Only three parameters can have trigger levels set at one time, but only one of the conditions needs to be satisfied for triggering to occur.

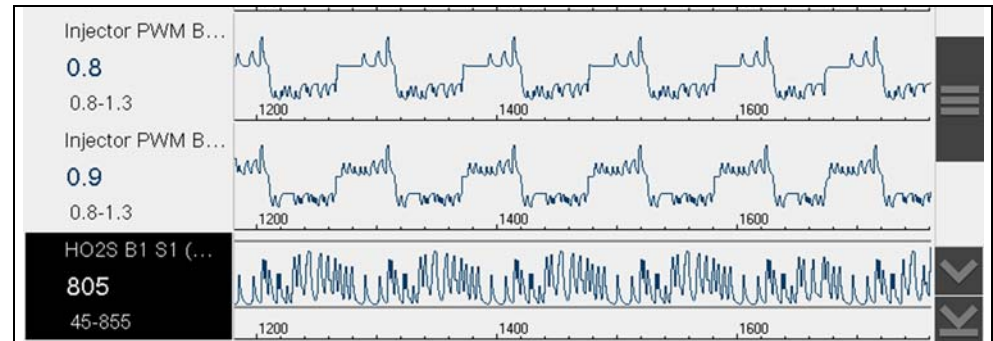

Figure 4-31 Trigger set (not armed)

▶ Arming triggers:

1. Select the **Trigger** icon.
2. Select **Arm Triggers**.

The trigger point lines change color to indicate an armed condition (Figure 4-32).

All set PID triggers are armed simultaneously (if more than one is set). Once armed it remains armed until you clear it or the trigger is activated.

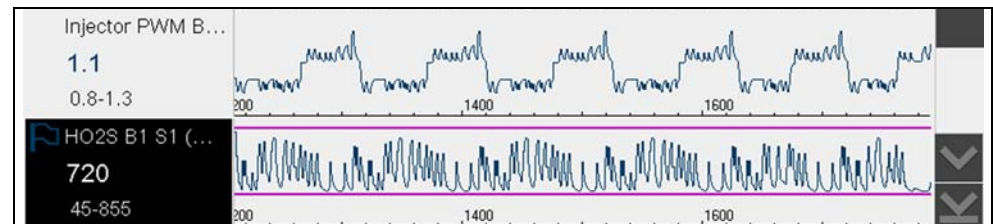

Figure 4-32 Trigger armed

About Activated Triggers

A trigger is activated when a PID value meets an upper/lower limit (trigger point).

When a trigger is activated:

- Data collection is briefly paused as the Scanner captures a recording of all available PID data, and saves it as a data file.
- A gray cursor line is displayed to indicate the point at which the data was paused or saved.
- An audible alarm is sounded
- A message displays indicating a data file was saved.
- Data collection continues.
- The activated PID trigger is disarmed.
- A red cursor line is displayed on the graph of the PID with the activated trigger to indicate where the trigger occurred. A green cursor line is displayed on all the other PID graphs to indicate their relationship to where the trigger occurred.

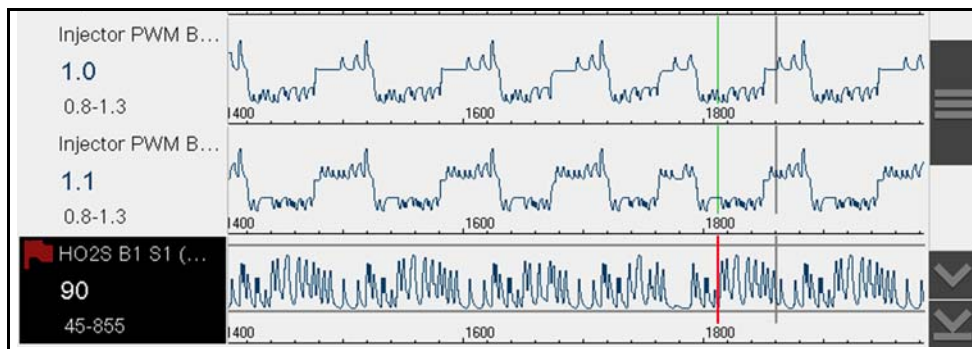

Figure 4-33 Trigger activated

4.6 Functional Tests

The **Functional Tests** selection is used to access OEM model specific subsystem tests. Available tests vary by manufacturer, year, and model. Only the tests supported by the motorcycle are displayed in the menu.

Typical functional tests:

- **Information Tests**—read-only tests (e.g. displaying serial or identification numbers)
- **Toggle Tests**—switch a component, such as a solenoid, relay, or switch, between two operating states.
- **Variable Control Tests**—command a certain value for a system or component.
- **Reset Tests**—reset adaptive or learned values
- **Scripted Tests**—these tests are software routines that place the vehicle into special operating modes for performing certain repairs, such as bleeding brakes with ABS.

Selecting Functional Tests opens a menu of test options that varies by make, year, and model. Selecting a menu option either activates the test or opens a submenu of additional choices. Follow all screen instructions while performing tests. How and what information is presented on the screen varies according to the type of test being performed and the vehicle being serviced.

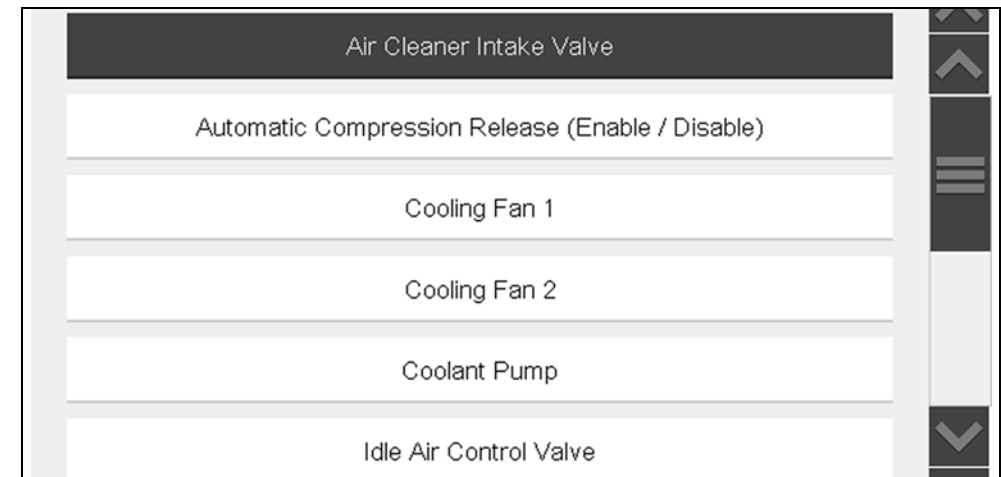

Figure 4-34 (Typical) Functional test menu

Toggle and variable control tests often display functional test controls on the toolbar at the top of the screen with PID data in the main body.

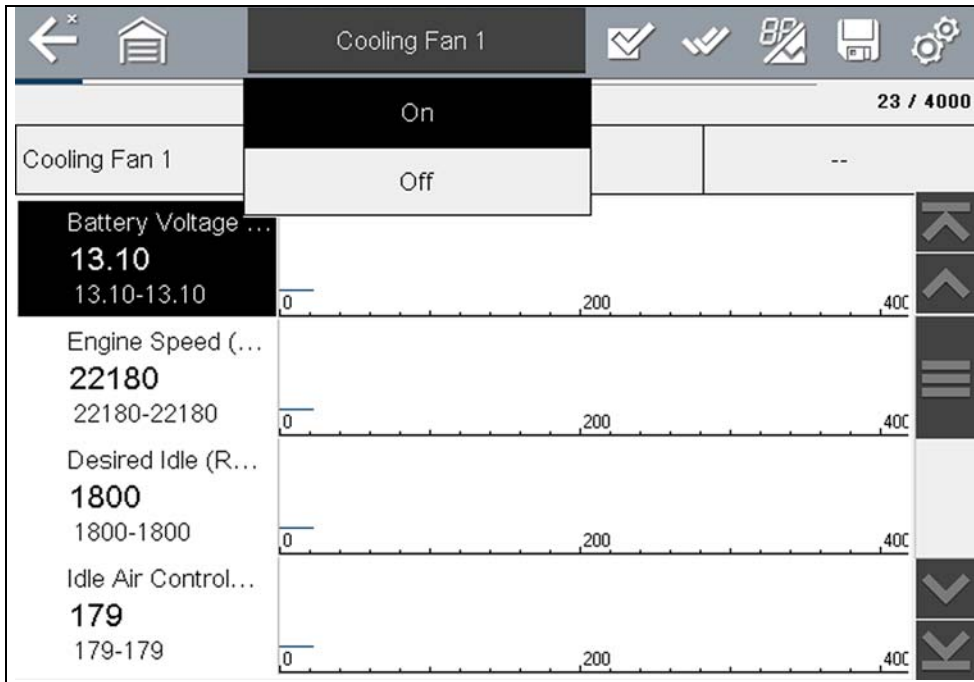

Figure 4-35 Functional test example

A Test icon on the toolbar activates the test, and a Return, or similarly named, icon cancels the test. For variable control tests, the variable value displays between the main body and the toolbar. Plus and Minus icons on the toolbar increase and decrease the variable value.

A Data List icon, shown to the left, is available on the toolbar for some tests. This feature allows you to change which data list displays in the main body without exiting the functional test. The icon is only available when the test is inactive.





This section describes the basic operation of the Previous Vehicles and Data function.



The **Previous Vehicles and Data** icon is located on the Home screen. This function allows you to select recently tested motorcycles and access saved data files.

Main Topic Links

- [Vehicle History](#) page 32
- [View Saved Data](#) page 33
- [Viewing Codes and Code Scan Results](#) page 33
- [Delete Saved Data](#) page 35

5.1 Previous Vehicles and Data Menu

The following options are available from the Previous Vehicles and Data menu:

- [Vehicle History](#)
- [View Saved Data](#) on page 33
- [Delete Saved Data](#) on page 35

5.1.1 Vehicle History

The diagnostic tool stores the identification of the last twenty-five motorcycles tested, so there is no need to go through the complete identification sequence when performing a retest after repairs have been made. The oldest record is deleted when a new vehicle is identified once there are twenty-five vehicles on file.

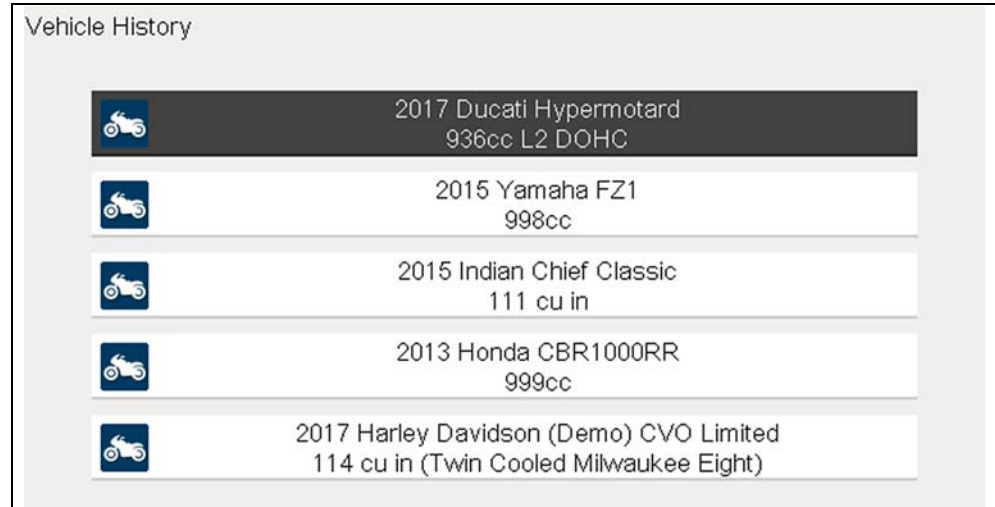

Figure 5-1 Vehicle history list



To select from the vehicle History:

1. Select **Previous Vehicles and Data** from the Home screen.
2. Select **Vehicle History** from the menu.
A list of up to 25 previously tested motorcycles displays. Each record is given a unique file name. Scroll to view the entire list.
3. With the item to be opened highlighted, either select it or press the **Y/✓** button. The vehicle confirmation screen displays.
4. Select **OK** or press the **Y/✓** button to continue.

5.1.2 View Saved Data

Selecting the **View Saved Data** menu option opens a list of all the saved data (movie) files and screen images that are stored in memory. Saved files are listed in chronological order by the date and time that they were created with the most recent files are at the top of the list.

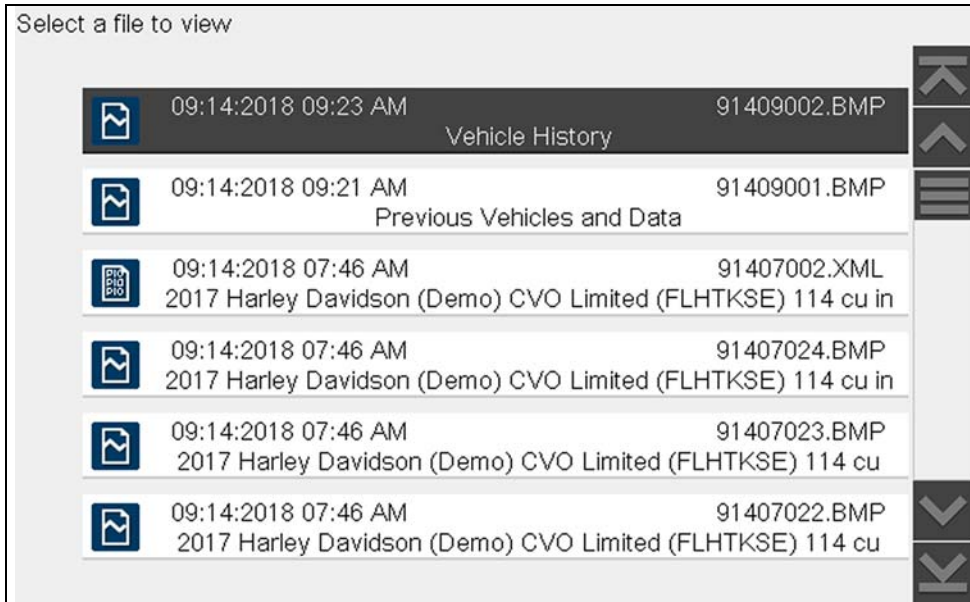

Figure 5-2 Saved data list

Selecting a file from the list, opens the file.

Saved data files can also be downloaded to a personal computer (PC) using the Mini USB jack. Once connected to the PC, the data files can be printed, transferred, and copied using ShopStream Connect. ShopStream Connect is a PC application that creates an interface between the diagnostic tool and a PC. See [ShopStream Connect™](#) on page 50.

To connect to a PC, see [Connect-to-PC \(File Transfer\)](#) on page 37.

NOTE

A maximum of 50 files are displayed. To view all (if more than 50) files stored, transfer the files to a PC and use ShopStream Connect. See [Connect-to-PC \(File Transfer\)](#) on page 37 for additional information.

To review a saved data file or image:

1. Select **Previous Vehicles and Data** from the Home screen.
2. Select **View Saved Data** from the menu.
3. Select a file to review from the list.

5.1.3 Viewing Codes and Code Scan Results

When code scan or single system code results are saved, they are saved in (.XML) file format ([Figure 5-3](#)).

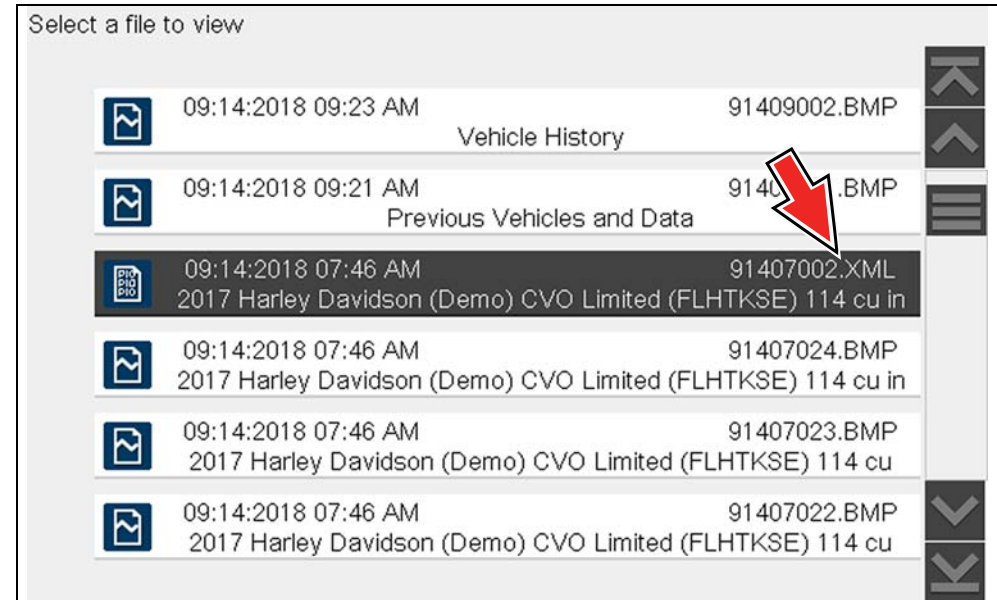

Figure 5-3 Typical - Code Results (.XML) file

Viewing Codes and Code Scan Reports on the Diagnostic Tool

Once saved, the code scan report can be viewed on the diagnostic tool in the same manner it was displayed originally.

To view saved codes and code scan report on the diagnostic tool:

1. Select **Previous Vehicles and Data** from the Home screen.
2. Select **View Saved Data**.
3. Select the code scan report .XML file from the list to view the file ([Figure 5-3](#)).

Selecting a system code or a code scan .XML file from the saved file list, opens that file onscreen ([Figure 5-4](#)).

Viewing / Printing the Code Scan Report

Once saved, the code scan report can be viewed and printed using ShopStream Connect, see [Printing the Code Scan Report on page 53](#).

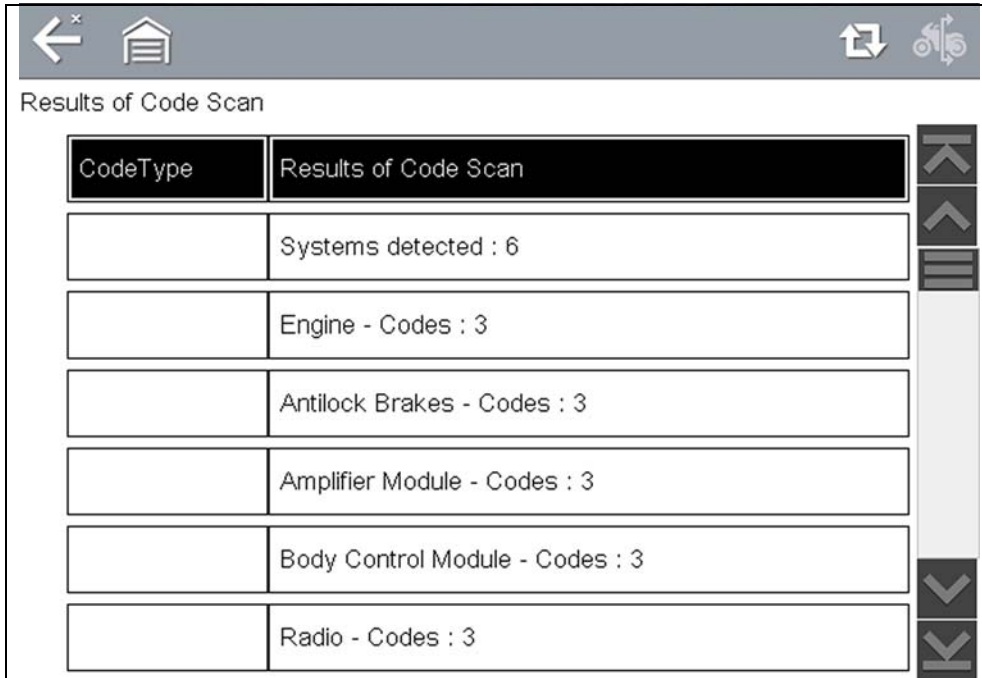

Figure 5-4 Typical - Code Scan Results (.XML file) viewed onscreen

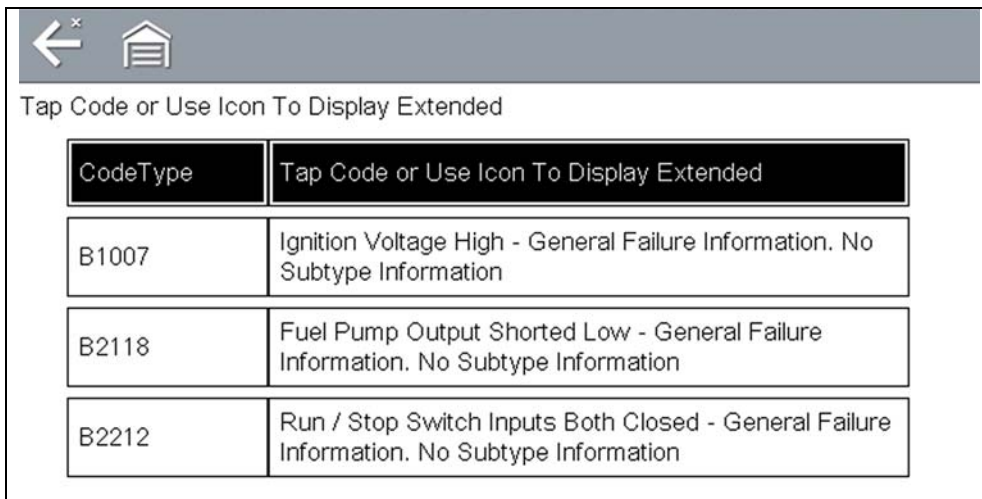

Figure 5-5 Typical - (Engine System) Code Results (.XML file) viewed onscreen



5.1.4 Delete Saved Data

This menu option is used to permanently erase saved files from memory.



To delete a saved file:

1. Select **Previous Vehicles and Data > Delete Saved Data**.

The list of saved files displays.

Select the file(s) to be deleted using the checkboxes.

Use the **Select All / Deselect All** icon as necessary.

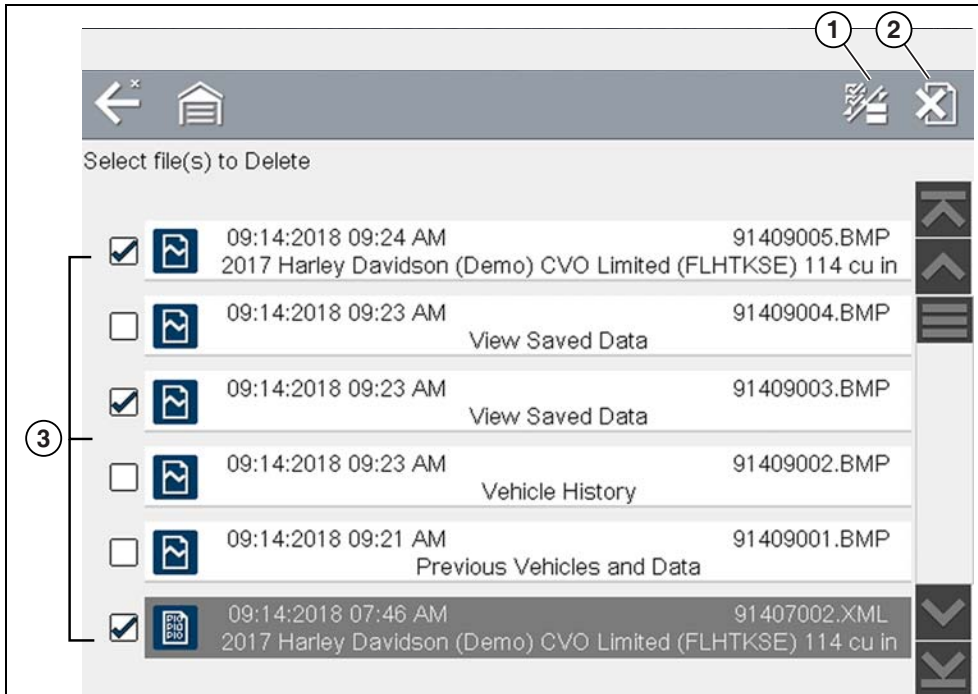

1— Select All / Deselect All Icon

2— Delete Icon

3— Selected files to be deleted

Figure 5-6

2. The files with checkboxes will be deleted. To delete the files select the **Delete** icon.
3. A confirmation message displays. Select an option:
 - **OK**—permanently deletes the selected file
 - **Cancel**—returns to the saved files list without deleting the selected file.



This section describes the basic operation of the Tools function.



The **Tools** icon is located on the Home screen. This function allows you to configure diagnostic tool settings to your preferences.

Main Topic Links

- [Connect-to-PC \(File Transfer\)](#) page 37
- [Configure Shortcut Button](#) page 37
- [System Information](#) page 37
- [Settings](#) page 38
 - [Configure Wi-Fi](#) page 42
 - [Configuring Scanner](#) page 42
 - [Configure Units](#) page 43
 - [High Contrast Toolbar](#) page 39
 - [Brightness](#) page 38
 - [Color Theme](#) page 39
 - [Font Type](#) page 40
 - [Backlight Time](#) page 40
 - [Touch Screen Calibration](#) page 40
 - [Time Zone](#) page 41
 - [Clock Settings](#) page 41
 - [Daylight Savings Time](#) page 42
 - [Time Format](#) page 42
 - [Date Format](#) page 42

6.1 Tools Menu

The following options are available from the Tools menu:

- [Connect-to-PC \(File Transfer\)](#)—use to transfer and share files with a personal computer (PC)
- [Configure Shortcut Button](#) on page 37—use to change the function of the shortcut button
- [System Information](#) on page 37—use to view configuration information for the diagnostic tool
- [Settings](#) on page 38—use to configure certain characteristics of the diagnostic tool

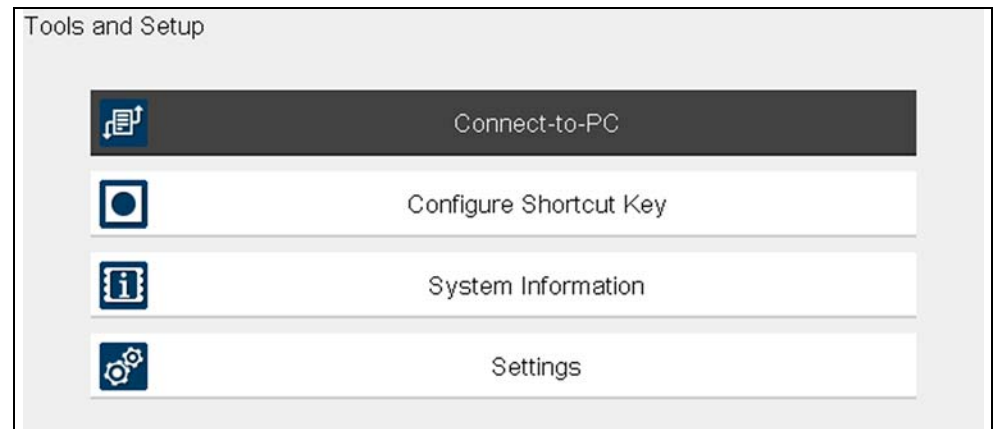



Figure 6-1 Tools menu



6.1.1 Connect-to-PC (File Transfer)

Connect-to-PC allows you to transfer saved data files on your diagnostic tool to your personal computer using a USB cable.

The optional ShopStream Connect™ PC software allows you to view, print and save data files on your PC. In addition, you can download software updates from the PC to the diagnostic tool. These features provide an ideal way to manage saved data files. The ShopStream Connect application is available free online, see [ShopStream Connect™ on page 50](#).

-  **To connect the diagnostic tool to a PC:**
1. Select **Tools** from the Home screen.
 2. Select **Connect-to-PC**.
A screen message displays stating that the diagnostic tool is in Connect-to-PC mode.
 3. Connect the supplied USB cable to the diagnostic tool and then to the PC.
The diagnostic tool, displays as an external drive. Using Windows File Explorer locate the “USERDATA” folder to find saved screenshots (.BMP), code files (.XML), and data files (.SCM).
 4. When finished, select **Exit** to return to the Tool menu, and disconnect the USB cable.

6.1.2 Configure Shortcut Button

This feature allows you to change the function of the **Shortcut** button. Options are:

- **Brightness**—opens the brightness setting screen.
- **Save Screen**—saves a bitmap image of the visible screen.
- **Save Movie**—writes PID data from buffer memory to a file for future playback.
- **Show Shortcut Menu**—opens the menu so you can quickly select from any of the functions.
- **Toggle Record/Pause**—programs the Shortcut button to work as the Pause and Play icons.

-  **To assign a function to the Shortcut button:**
1. Select **Tools** from the Home screen.
The Tools menu opens.
 2. Select **Configure Shortcut button** from the menu.
 3. Select a function from the menu.

4. Select the **Back** on the toolbar or press the **N/X** button to return to the options menu.

6.1.3 System Information

System Information allows you to view patent information and system information, such as the software version and serial number of your diagnostic tool.

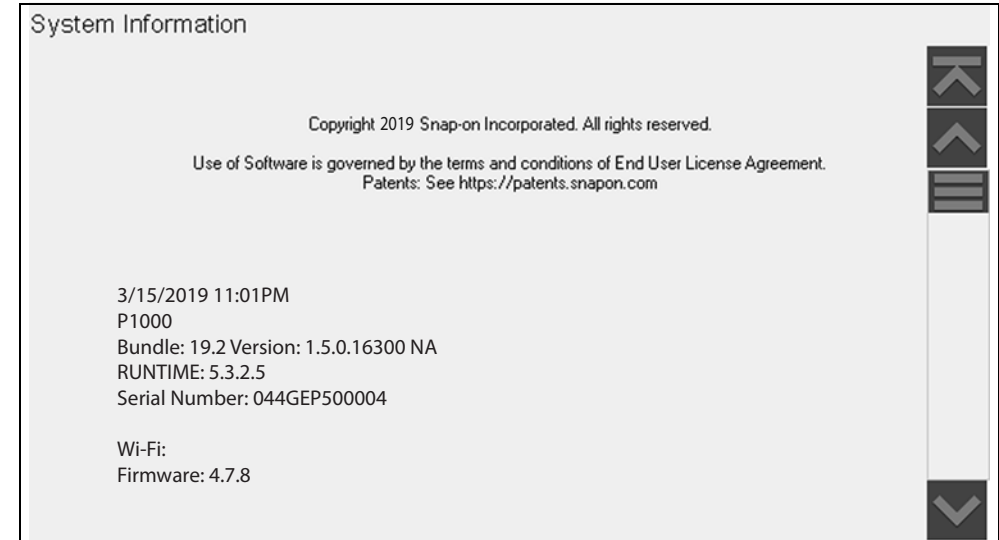



Figure 6-2 System information

-  **To display the System information screen:**
1. Select **Tools** from the Home screen to open the menu.
 2. Select **System Information** from the menu.
The System Information screen displays.
 3. Scroll as needed to view all of the data.
 4. Select **Back** on the toolbar or press the **N/X** button to return to the options menu.



6.1.4 Settings

This Tools selection allows you to adjust certain basic diagnostic tool functions to your personal preferences. Selecting opens an additional menu that offers the following:

- System Settings - see [System Settings](#) on page 38
- Configure Wi-Fi - see [Configure Wi-Fi](#) on page 42
- Configure Scanner - see [Configuring Scanner](#) on page 42
- Configure Units - see [Configure Units](#) on page 43

System Settings

Selecting System Settings opens a menu with three options; Display, Date & Time and Auto VIN. Selecting either Display or Date & Time opens an additional menu (see below). Selecting Auto VIN provides the option to turn the Instant Vehicle ID feature on/off.

Display options include:

- [Brightness](#) on page 38—adjusts the intensity of the screen back lighting.
- [Color Theme](#) on page 39—changes the background color of the screen display.
- [High Contrast Toolbar](#) on page 39—enhances toolbar graphics for poor lighting conditions.
- [Font Type](#) on page 40—switches between standard and bold text for better visibility.
- [Backlight Time](#) on page 40—adjusts how long the screen stays on with an idle diagnostic tool.
- [Touch Screen Calibration](#) on page 40—calibrates the touch screen display.

Date & Time options include:

- [Time Zone](#) on page 41—sets the internal clock to the local time standard.
- [Clock Settings](#) on page 41—sets the time on the internal clock.
- [Daylight Savings Time](#) on page 42—configures the clock for Daylight Savings Time.
- [Time Format](#) on page 42—switches the time displays between a 12 or 24 hour clock.
- [Date Format](#) on page 42—configures how the month, date, and year displays.

DISPLAY (settings)

Brightness

Selecting this option opens the brightness setting screen for adjusting the back lighting of the display ([Figure 6-3](#)).

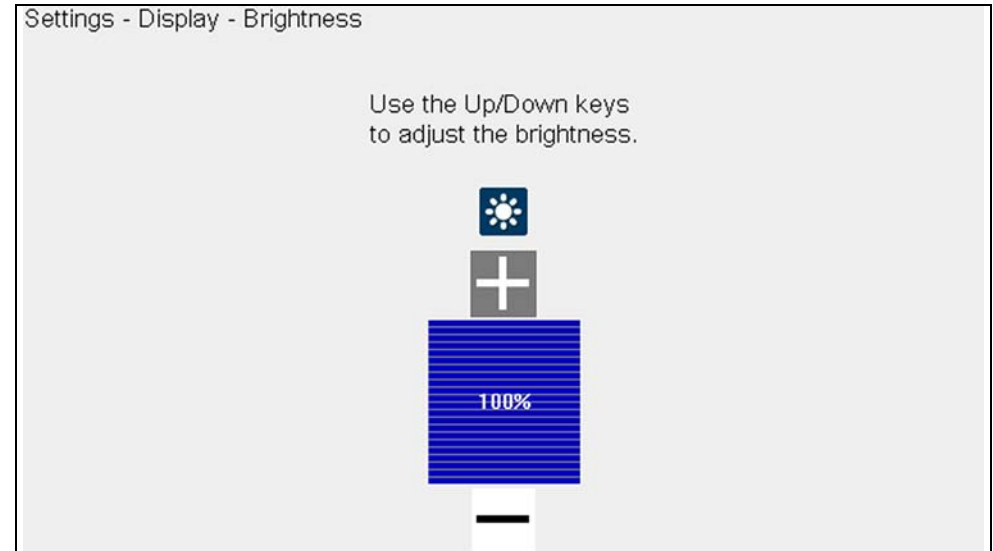

Figure 6-3 Brightness setting

Each push of the **Plus** and **Minus** icons, or the up (▲) and down (▼) arrows, incrementally changes the back lighting up or down respectively.

Select **Back** from the toolbar or press the **N/X** button to exit.

Color Theme

This option allows you to select between a white and black background for the screen. The black background can be beneficial when working under poor lighting conditions.

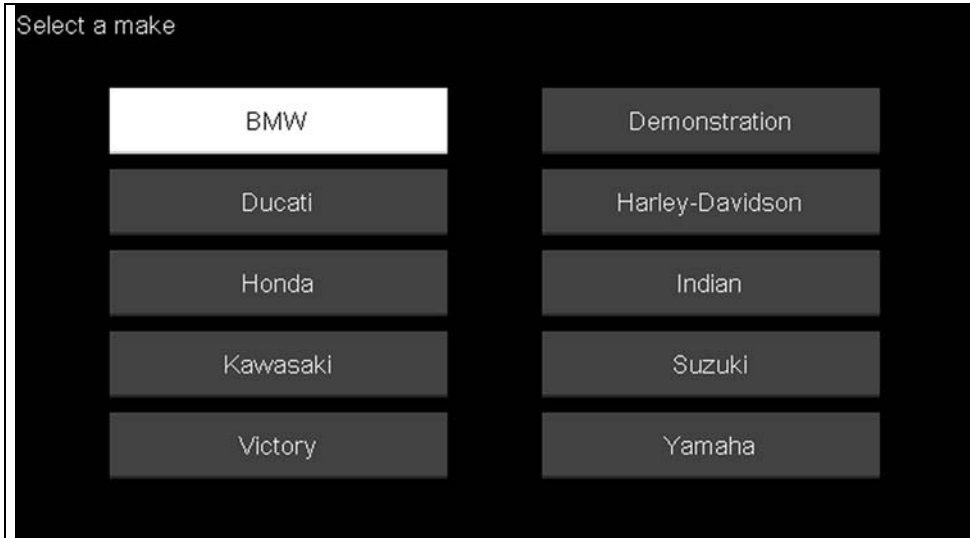

Figure 6-4 Night Theme

Selecting opens a menu with two choices: **Day Theme** (white background) and **Night Theme** (black background). Make a selection and a “please wait” message momentarily displays followed by the Home screen. The new toolbar setting is now active.

High Contrast Toolbar

This option allows you to switch to a high contrast toolbar. This toolbar features black and white icons with crisp graphics that are easier to see in poor lighting conditions or bright sunlight.

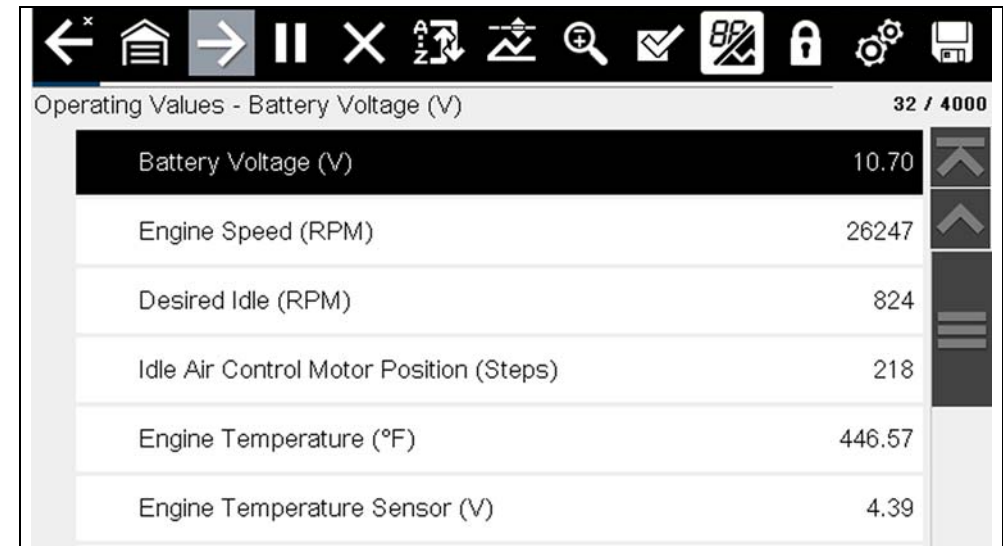

Figure 6-5 High-contrast toolbar

Selecting opens a menu with two choices; Color Toolbar and High Contrast Toolbar. Select and a “please wait” message displays followed by the Home screen. The new setting is now active.

Font Type

This option allows you to select between standard and bold faced type for the display screen. Bold type makes screen writing more legible under poor lighting or bright sunlight conditions.

Selecting opens a menu with two choices: Normal Font and Bold Font. Select a menu item or scroll and then press the **Y/✓** button to make a selection. The change is instantaneous. Select the Back or Home icon on the toolbar to return to either the Settings menu or the Home screen.

Operating Values - Battery Voltage (V)		19 / 4000
Battery Voltage (V)	10.70	↑
Engine Speed (RPM)	26247	↑
Desired Idle (RPM)	824	≡
Idle Air Control Motor Position (Steps)	218	≡
Engine Temperature (°F)	446.57	≡
Engine Temperature Sensor (V)	4.39	≡
Intake Air Temperature Sensor (V)	2.64	↓

Figure 6-6 Bold Type

Backlight Time

This option allows you to configure how long the screen backlight remains on when the diagnostic tool is inactive. The following choices are available:

- Always On
- 15 Seconds
- 30 Seconds
- 45 Seconds
- 60 Seconds

Select the menu item desired, or scroll and then press the **Y/✓** button to make a selection. Select **Back** or **Home** on the toolbar to return to either the Settings menu or the Home screen.

Touch Screen Calibration

Calibrating the touch screen maintains the accuracy of the touch-sensitive display.

IMPORTANT

To avoid serious damage to the diagnostic tool, always complete the touch screen calibration sequence once it has begun. Never turn off the diagnostic tool while a screen calibration is in process.



To calibrate the touch screen:

1. Select **Tools** from the Home screen.
2. Select **Settings>System Settings>Display>Touch Calibration**.
The calibration screen opens ([Figure 6-7](#)).

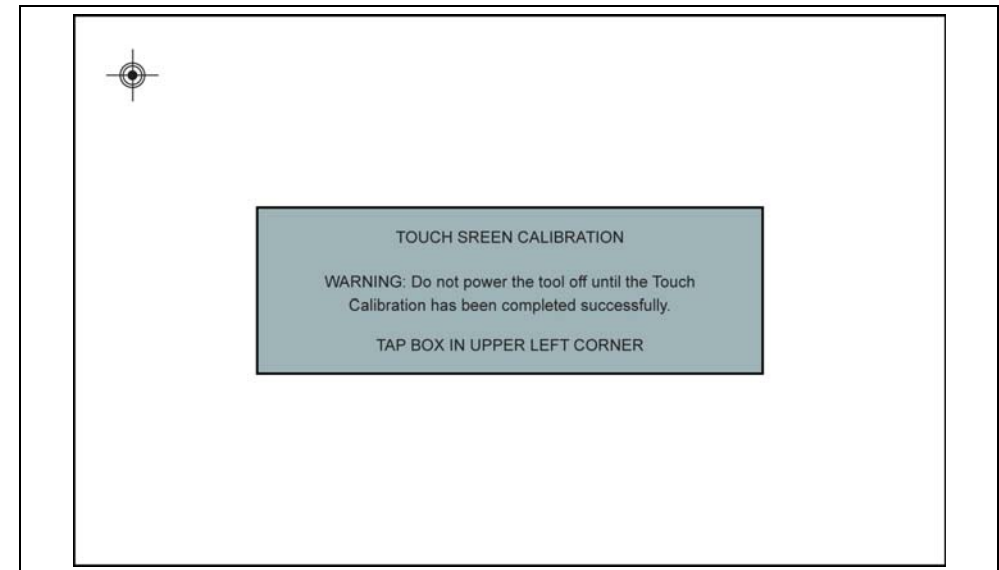

Figure 6-7 Touch screen calibration

3. Select the center of each alignment indicator on the screen as they display in the corners of the screen, starting in the upper left corner.
4. Once all four indicators have been selected, the verification process starts the procedure again. Select the center of each alignment indicator when prompted.

- If the calibration is successful, the “Touch Calibration Results - Passed” screen is displayed (*Figure 6-8*). Press the **Y** button to complete the process and return to the Display menu.
- If the calibration is not successful, the “Touch Calibration Results - Failed” screen is displayed. Press the **Y** button to perform the procedure again.

The results screen (*Figure 6-8*) shows the entered calibration of each indicator. Ideal calibration would be to select each indicator exactly in the center, however selection inside the displayed circle is acceptable. If selecting the center is difficult using your finger, use a touch screen stylus (not included).

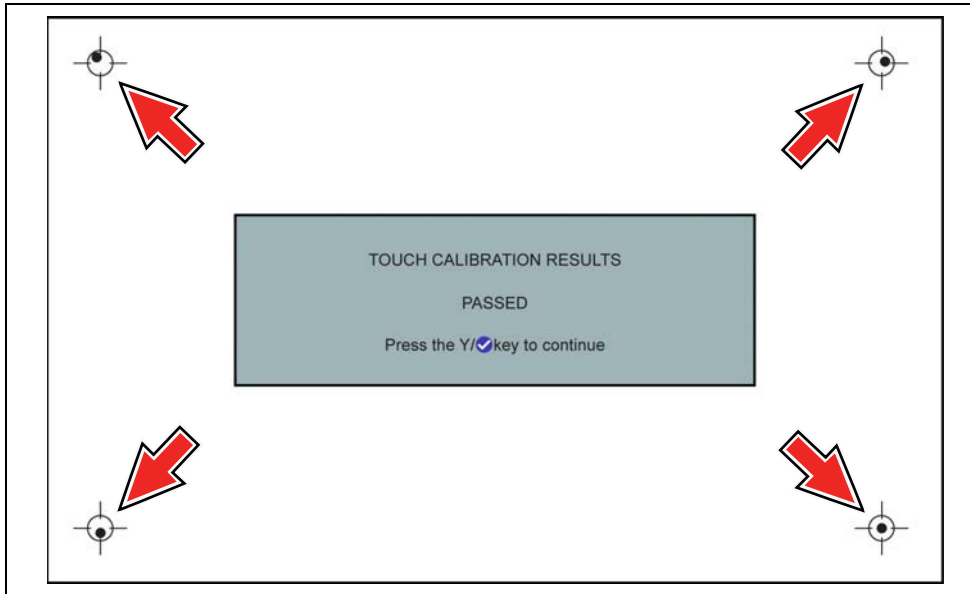

Figure 6-8 Touch screen calibration - Passed

DATE & TIME (settings)

Time Zone

This option opens a menu of time zone settings. Scroll to highlight, then select the local time zone. The display returns to the Settings menu once a time zone is selected.

Clock Settings

This option opens a window for resetting the time on the real-time clock.



To set the clock:

1. Select **Tools** from the Home screen to open the menu.
2. Select **Settings** from the menu.
3. Select **Clock Settings** from the menu.

A warning message briefly displays followed by the Clock Settings screen (*Figure 6-9*).

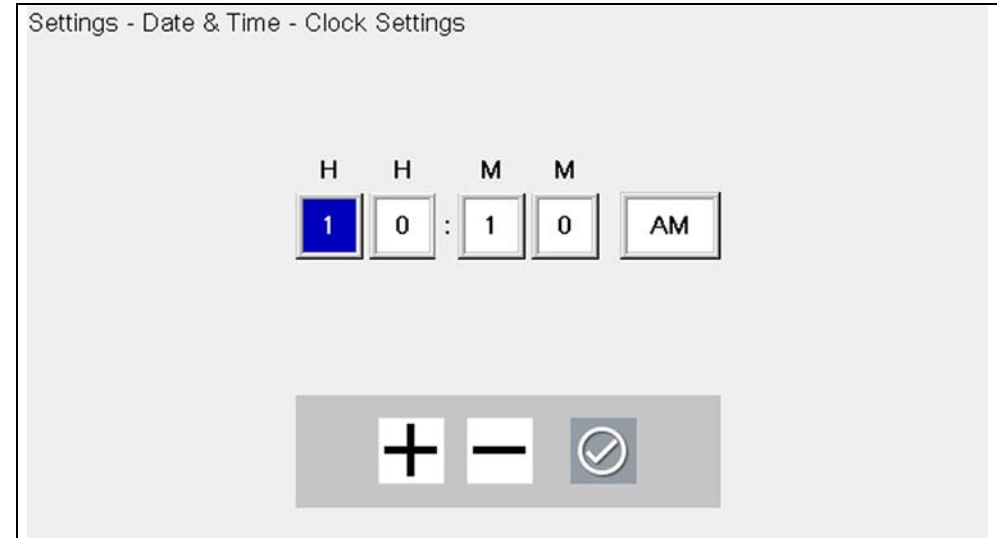

Figure 6-9 Clock settings

4. Select the **up (+)** icon on the screen or press the **up (▲)** button to incrementally increase the number in the highlighted field. Select the **down (-)** icon on the screen or press the **down (▼)** button to incrementally decrease the number.
5. Select the **check (✓)** icon on the screen or press the **Y/✓** button to move the highlight to the next field.
6. Repeat Step 4 and Step 5 until the correct time is displayed.
7. Select the **Back** icon on the toolbar or press the **N/X** button to close the Clock Settings window and return to the Settings menu.

Daylight Savings Time

This option opens a menu to configure the internal clock for Daylight Savings Time. Choose from:

- **ON**—sets the clock for Daylight Savings time.
- **OFF**—sets the clock for standard time.

Make either selection, then select the **Back** icon or press the **N/X** button to return to the menu.

Time Format

This option determines whether time is displayed on a 12 or 24 hour clock. Selecting opens a menu with two choices:

- **24 Hour Format**
- **12 Hour Format**

Make either selection, then select the **Back** icon or press the **N/X** button to return to the menu.

Date Format

This option allows you to select how date information is displayed. Select from:

- **(MM_DD_YYYY)**—Month, Day, Year
- **(DD_MM_YYYY)**—Day, Month, Year
- **(YYYY_MM_DD)**—Year, Month, Day

Make a selection, then select the **Back** icon or press the **N/X** button to return to the menu.

Configure Wi-Fi

Selecting **Configure Wi-Fi** allows you to configure and troubleshoot the diagnostic tool Wi-Fi connection, see [Wi-Fi Connection / Troubleshooting](#) on page 44.

Configuring Scanner

This option allows you to change the scanner display to toggle scales on and off. Scales are the graduations and values that display on the horizontal axis at the base of the parameter graphs. The waveform fills the entire graph area with scales switched off.

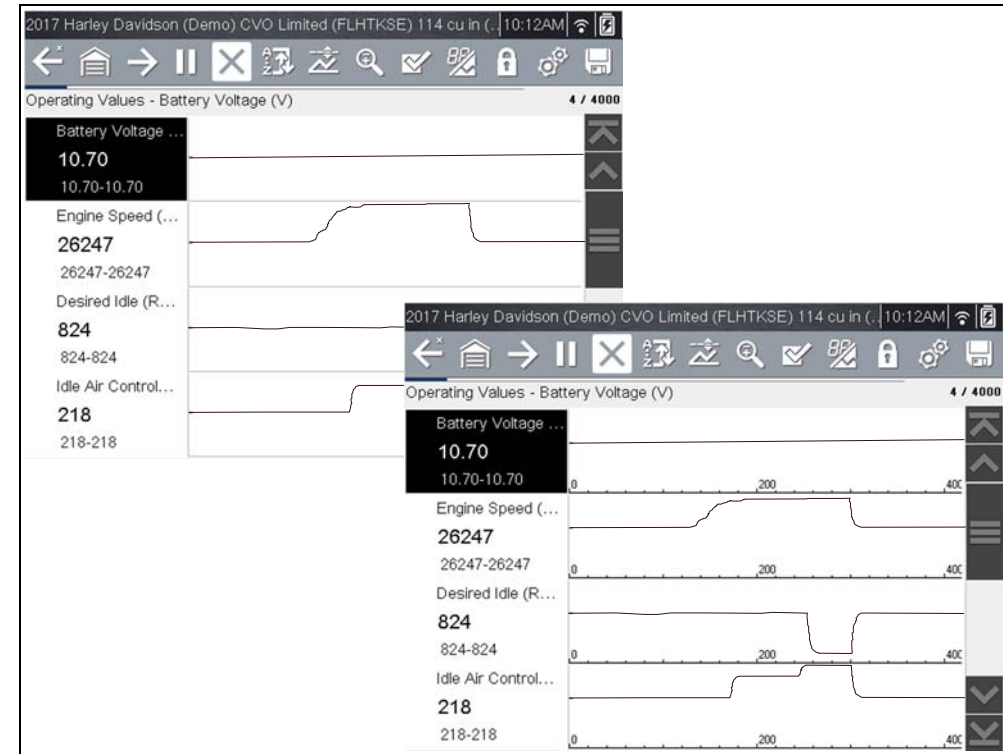

Figure 6-10 Scales hidden (upper), displayed (lower)



To change hide/show scales:

1. Select **Tools** from the Home screen.
2. Select **Settings** from the Tools and Setup menu.
3. Select **Configure Scanner** from the Settings menu.
4. Highlight either menu entry to make a selection:
 - **Show Graph Scale**—to switch the scales on.
 - **Hide Graph Scale**—to switch the scales off.
5. Select the **Back** icon or press the **N/X** button to return to the Settings menu.



Configure Units

Selecting opens a dialog box that allows you to choose between US customary or metric units of measure for various units.

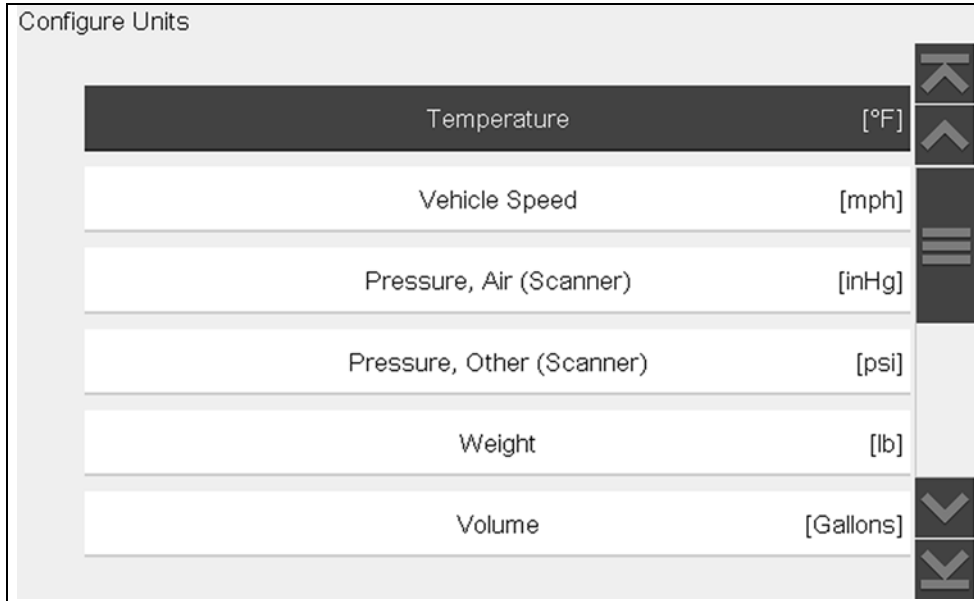



Figure 6-11 Configure units menu

-  **To change the units setup:**
1. Select **Tools** from the Home screen to open the menu.
 2. Select **Configure Units** to open the menu.
 3. Select an item from the Configure Units menu.
 4. Select a setting from the listed choices.
 5. Select **Back** on the toolbar or press the **N/X** button to return to the options menu.

The diagnostic tool is equipped with Wi-Fi connection capability, however the Wi-Fi connection is solely dedicated to our Snap-on Web Services Network.

Connecting to Wi-Fi allows the tool to periodically receive messages from Snap-on. These messages will be displayed to inform you of software updates and upgrades, as well as other important information.

This section includes information on Wi-Fi connection and troubleshooting.

Main Topic Links

- [Checking if Wi-Fi is On/Off](#) page 44
- [Checking if Wi-Fi is Connected](#) page 44
- [Wi-Fi Icons \(Setup\)](#) page 45
- [Turning Wi-Fi On and Connecting to a Network](#) page 45
- [Add Network Advanced \(Connecting to a hidden network\)](#) page 46
- [Wi-Fi Testing](#) page 46
- [Wi-Fi Troubleshooting and Status Messages](#) page 47

7.1 Checking if Wi-Fi is On/Off

If the Wi-Fi indicator is displayed in the title bar, Wi-Fi is on. If Wi-Fi is off, see [Turning Wi-Fi On and Connecting to a Network](#) on page 45 to turn it on and connect.

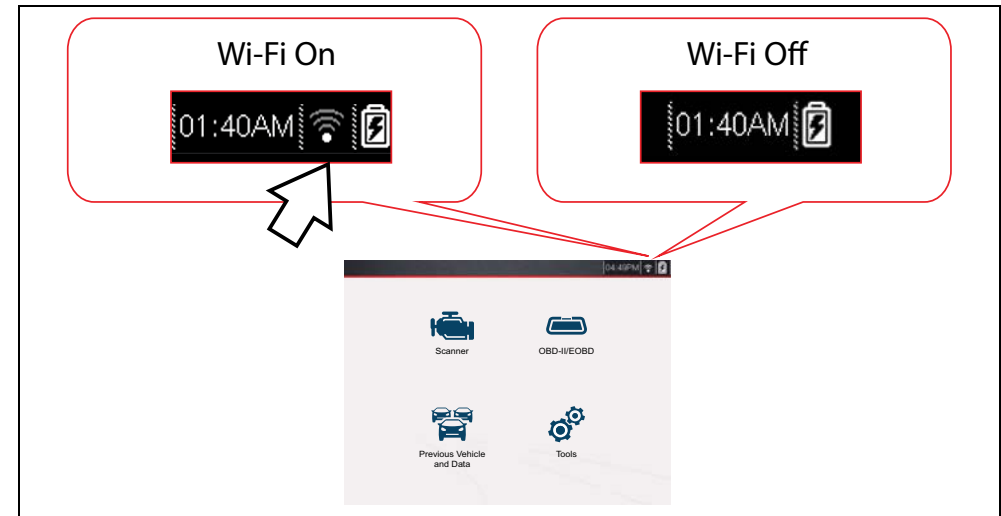





7.2 Checking if Wi-Fi is Connected

Check the Wi-Fi indicator in the title bar:

	Wi-Fi is on and connected to a network (1 to 3 bars).
	Wi-Fi is on, but not connected (zero bars). See Wi-Fi Troubleshooting and Status Messages on page 47.

7.3 Wi-Fi Icons (Setup)

Familiarize yourself with the following Wi-Fi icons and indicators from the Wi-Fi configuration screen.

Wi-Fi Icon (toggle type)		Wi-Fi Test Icon	Wi-Fi Signal Strength Indicator	
				
Select to turn Wi-Fi ON	Select to turn Wi-Fi OFF	Select to open the Wi-Fi Test screen	Zero bars indicates no signal	Three bars indicate full strength signal
Displayed on Wi-Fi configuration screen only			Displayed on the title bar next to the battery level indicator	

7.4 Turning Wi-Fi On and Connecting to a Network

1. From the Home screen, select **Tools > Settings > Configure Wi-Fi**.
2. Select the **Wi-Fi icon**  to turn Wi-Fi on.

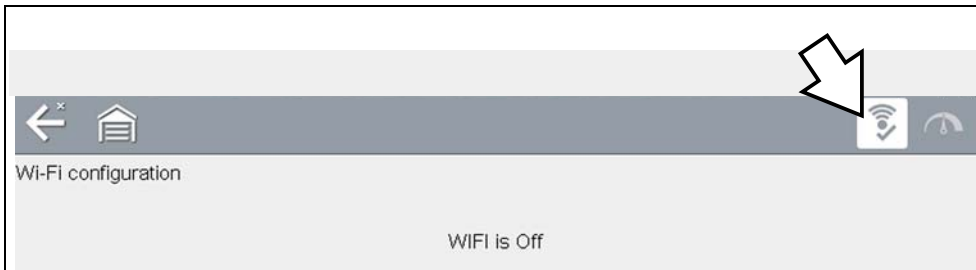



Figure 7-1 Wi-Fi Icon (shown off)

3. The Wi-Fi icon will change to , indicating Wi-Fi is on.
The screen will change to display available supported network connections.
4. Select your network. Use the scroll feature to show all active connections ([Figure 7-2](#)).

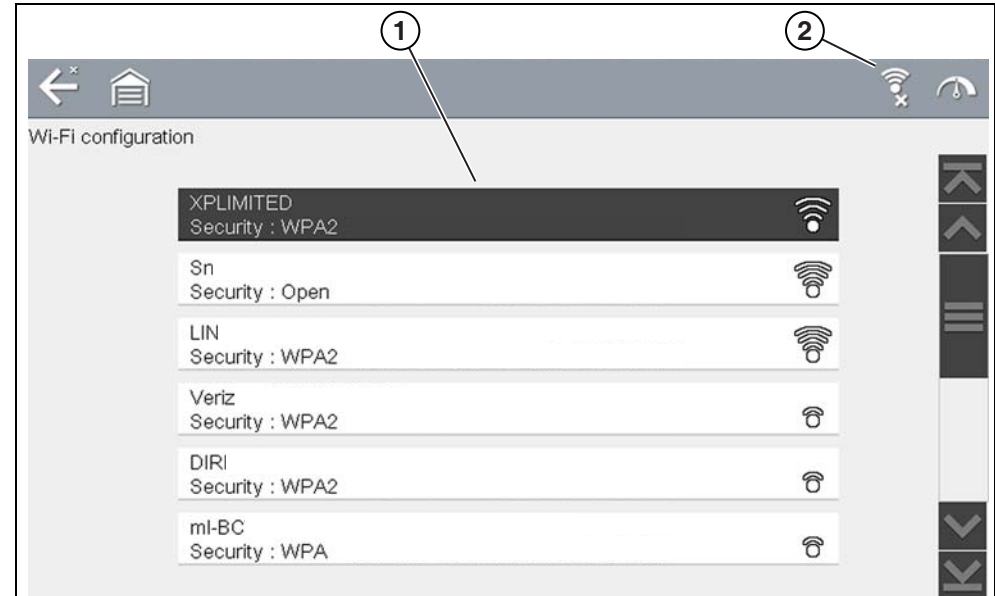

Figure 7-2 Wi-Fi Configuration Screen

- 1— Available Network Connections
- 2— Wi-Fi Icon (Wi-Fi shown on)

NOTES

A password is required when choosing a secured (protected) network. Enter the password using the on-screen keyboard and then select the check mark on the keyboard to continue.

Networks with a proxy, challenge page, or that require the user to accept terms of usage are not supported.

Wi-Fi performance varies depending on your wireless network equipment and ISP.

5. Select **Connect** to connect to your desired network or **Cancel** to cancel the request.
 6. From the Connect confirmation screen select **OK** to continue using this connection or **Forget** to disconnect this connection.
- If the status message “Not Connected” is displayed, retry the configuration process or see [“Wi-Fi Testing” on page 46](#) for additional information.



7.5 Add Network Advanced (Connecting to a hidden network)

The Add Network selection allows you to connect to a network that is not broadcasting its name (not visible in the displayed network list). These networks are also known as "hidden" networks.

To connect to a hidden network you will first need to know the following:

- Network Security Type
 - Open (only need SSID)
 - WPA or WPA2 (Pre-shared key)
 - WEP (WEP key)
- Network name or SSID (Service Set Identifier)
- Network Password



Connecting to a Hidden Wi-Fi Network

1. From the Home screen, navigate to **Tools > Settings > Configure Wi-Fi**.
2. Select **Add Network Advanced** from the network list (scroll to end of list).
3. Select security type Open, WPA, WPA2, or WEP. Refer to the router user manual or your IT administrator to determine the type.
4. Enter the network name or SSID
5. Enter the network password.
6. Select **Connect** at the prompt to connect to the network.
7. Select **OK** at the confirmation screen to continue using this connection, or **Forget** to disconnect this connection.

7.6 Wi-Fi Testing

If you are experiencing network connection issues, an automated testing feature is available to quickly test your network connection.



Testing Connections

1. Before you start the automated testing procedure, turn off the diagnostic tool and then turn it on. This clears previous testing messages from memory.
2. Connect to your desired network, see ["Turning Wi-Fi On and Connecting to a Network" on page 45](#).
3. From the Wi-Fi configuration screen, select the **Wi-Fi Test** icon to open the network connection test screen ([Figure 7-3](#)).

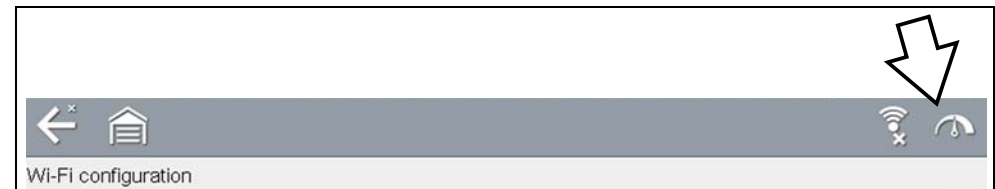

Figure 7-3 Wi-Fi Test Icon

The network connection test is an automated test that begins when the screen is displayed. Network connection systems are tested in sequence and display a status indicator

(Red = test failed, Yellow = test is process, or Green = test completed satisfactorily) when finished ([Figure 7-4](#)).

Connectivity of the following systems are checked:

- **Hardware**
- **Router**
- **Internet**
- **HTTP**
- **Web Services Network**

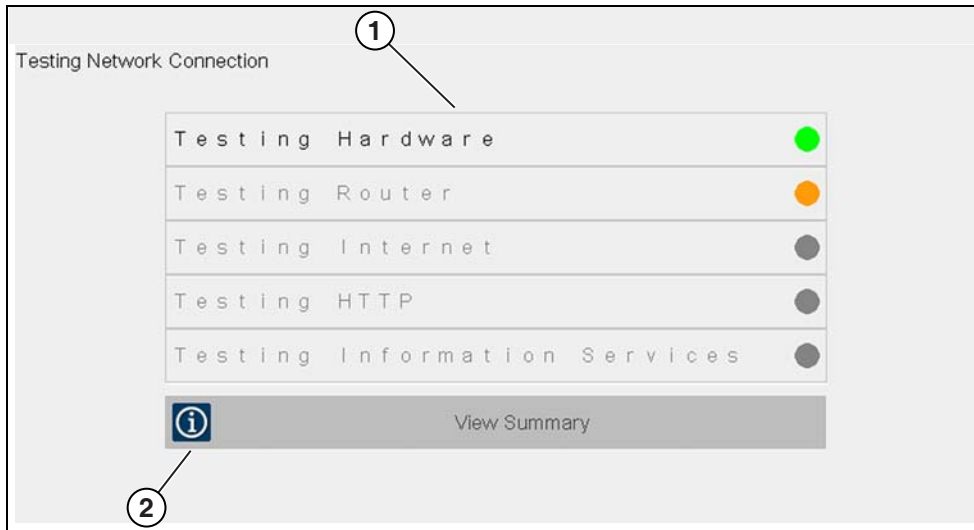

Figure 7-4 Connection Tests

1— Connection Tests**2— View Summary**

4. If a connection issue(s) is present, select **View Summary** to review the results. The summary information is helpful if you are experiencing difficulties with your connection (Figure 7-5). Scroll through the summary information to review the test results for each system and Tip messages for the current connection issue. See *Connection Tests - Troubleshooting* chart in “[Wi-Fi Troubleshooting and Status Messages](#)” on page 47 for additional information.

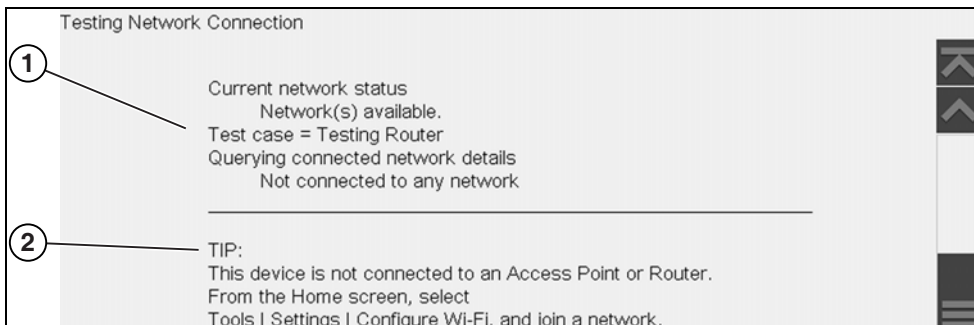

Figure 7-5 View Summary

1— Connection Test Results**2— Connection Issue Tip Message**

7.7 Wi-Fi Troubleshooting and Status Messages

The following troubleshooting information is not inclusive and is meant as a guide only. Other issues and solutions may arise that are not stated here. The following description of terms are provided for reference as used in the following troubleshooting chart:

- **Router** - The data transmission device directly connected to your ISP.
- **Remote Wireless Access Point** - A wireless connection device between the router and your diagnostic tool.
- **Wi-Fi Radio** - The internal diagnostic tool radio transmitting and receiving Wi-Fi signals.
- **Network Connection** - Also called Wi-Fi connection. The configured Wi-Fi router connection the diagnostic tool connects to. This connection can be secured (password protected) or unsecured (open).

Router Information

Router compatibility and setup are important factors to check when trying to determine connectivity problems. Although we have tested this device at the factory to verify connectivity, we cannot guaranty its connectivity with your specific equipment. There may be some situations that require your time for router connection troubleshooting and/or additional consultation and equipment. Snap-on Incorporated is not responsible for any costs incurred for any additional equipment, labor or consultation charges or any other costs that may result from correcting non-connectivity issues with this device.



Check Router Settings

Verify the following router settings **BEFORE** you begin troubleshooting a non-connectivity or “No Connection” problem. After each check, make any corrections as necessary then retest for connectivity. **Contact your IT administrator or ISP for assistance.**

1. Check your router connection and if applicable, the remote wireless access point connection.
2. Clear saved Wi-Fi networks, see [Clearing Wi-Fi Networks on page 48](#).
3. Verify:
 - (a). Router is configured to use Dynamic Host Configuration Protocol (DHCP), not a static IP address.
 - (b). Router and/or settings for this device are configured to 2.4GHz. 5GHz is not supported.
 - (c). Router is configured to B/G and/or N standard wireless networks to 2.4GHz. 5GHz is not supported. See your router "User Guide" for setup, connection and troubleshooting procedures.
4. Check for router firmware and update to current version, if applicable.
5. Restart or reset the router. See your router "User Guide" for procedures.
6. Connect to a different router.

Clearing Wi-Fi Networks

1. Select the Wi-Fi network that you are trying to connect to from the list of saved networks on the Wi-Fi configuration menu.
The Wi-Fi Summary page displays.
2. Select **FORGET**
The Wi-Fi Configuration menu displays.
3. Repeat steps (1) and (2) for ALL saved Wi-Fi networks.
4. Once all saved Wi-Fi networks have been deleted (forgotten) turn off the diagnostic tool.
5. Turn on the diagnostic tool and connect to the desired Wi-Fi network, see [Turning Wi-Fi On and Connecting to a Network on page 45](#).

General -Troubleshooting		
Problem	Possible Cause	Corrective Action
Web Services are not available	Access may be temporarily unavailable	Try to access at a later time as updates may be in process.
	Wi-Fi radio is turned Off	1. From the Home screen, navigate to Tools > Settings > Configure Wi-Fi . 2. Select the Wi-Fi icon and turn the Wi-Fi radio on. The Wi-Fi icon will change from a green check mark icon to red "X" mark icon indicating Wi-Fi radio is on. 3. Connect to a known good network.
	Not connecting to a network	1. Clear saved Wi-Fi networks, see Clearing Wi-Fi Networks on page 48 . 2. Connect to a network. 3. From the Configure Wi-Fi screen select the Wi-Fi Test icon and review the results. See Connection Tests - Troubleshooting in the following table .
Wi-Fi connection drops off or disconnects intermittently	Wi-Fi Signal strength insufficient	Check Wi-Fi signal strength - out of range or interference. Move closer (within 50 Ft. (15 M) or into a direct open sight-line of the router or if applicable, remote wireless access point. Eliminate interference from overhead lights, windows, walls, other wireless devices, metal objects and devices that emit electrostatic discharge.
	Router overloaded	Disconnect/disable other Wi-Fi devices connected to the router.



Connection Tests - Troubleshooting

Failed Test	Possible Cause (Displayed Tip Message*)	Corrective Action / Checks
Hardware	Wi-Fi radio not responding and/or will not turn off	Contact Customer Support for assistance.
	Wi-Fi radio not responding and/or will not initialize	
	Missing or corrupt firmware file(s)	
Router	This device is not connected to a router	Check Wi-Fi signal strength - out of range or interference. Move closer (within 50 Ft. (15 M) or into a direct open sight-line of the router or if applicable, remote wireless access point. Eliminate interference from overhead lights, windows, walls, other wireless devices, metal objects and devices that emit electrostatic discharge.
		Check router connection and setup. See Check Router Settings on page 48 for procedure.
Internet	This device is not connected to the Internet or has no DNS	Check router connection and setup. See Check Router Settings on page 48 for procedure.
		Domain Name System (DNS) server not connected. Contact your Internet service provider (ISP).
HTTP	This device cannot communicate using HTTP	Check if your Internet access uses a "Proxy" or "Accepting terms in a browser" protocol, or uses a challenge page. These protocols are not supported by this device. Contact your IT administrator or ISP for options.
Web Services Network	Web Services may be temporarily unavailable	Try to access at a later time as Web Services may be performing updates to the service.
	or Not connecting to a network	Check router connection and setup. See Check Router Settings on page 48 for procedure.
* See Wi-Fi Testing on page 46 for additional information.		



Introduction

This section provides a brief introduction to the features and operation of ShopStream Connect (SSC).

SSC is a companion PC application (provided at no charge) that extends the capabilities of your diagnostic tool, by connecting to your PC.

SSC allows you to:

- Print data files, screenshots and code scan reports
- Download software upgrades and updates to your PC, and then install them on to your diagnostic tool.
- Transfer data files bi-directionally between your diagnostic tool and your PC.
- View, save and manage your data files on your PC.
- Add or edit notes and comments to your data files.

The ShopStream Connect (SSC) software is available online at:

<http://diagnostics.snapon.com/ssc>

Complete ShopStream Connect operation instructions can be found in the ShopStream Connect User Manual, located online at:

<http://diagnostics.snapon.com/usermanuals>

Main Topic Links

- [Using SSC \(Connecting to your PC\)](#) page 50
- [SSC Main Screen](#) page 51
- [Scanner DataViewer](#) page 52
- [Image Viewer](#) page 52
- [Printing the Code Scan Report](#) page 53
- [Customizing the Code Scan Report](#) page 54
- [Software Upgrades and Updates](#) page 55

8.1 Using SSC (Connecting to your PC)



To connect and use SSC with your diagnostic tool:

1. Download and install SSC on your PC from:
<http://diagnostics.snapon.com/ssc>
2. Turn your diagnostic tool on.
3. Connect the supplied USB cable from the USB jack on your diagnostic tool to your PC:
4. From the diagnostic tool Home screen, select **Tools > Connect-to-PC**.

The “**Device is now in Connect-to-PC mode**” screen message is displayed (*Figure 8-1*) and the ShopStream Connect software will open automatically on your PC (*Figure 8-2*).

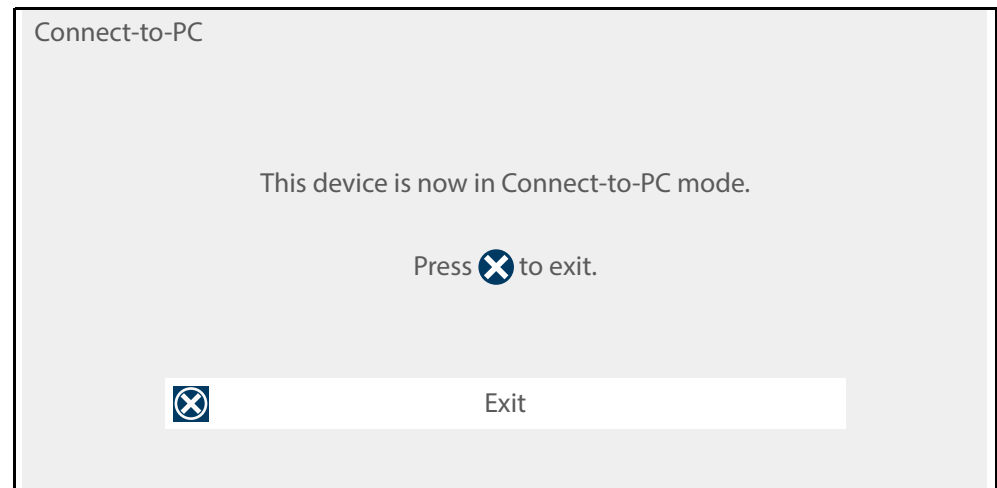

Figure 8-1

If the ShopStream Connect software does not open, open it from the Windows Start menu or use the ShopStream Connect shortcut icon on the Windows desktop (automatically created during installation).

8.2 SSC Main Screen

The ShopStream Connect software will open automatically when you connect the diagnostic tool to your PC USB connection, *Using SSC (Connecting to your PC)* on page 50.

The following shows the main screen layout for ShopStream Connect software.

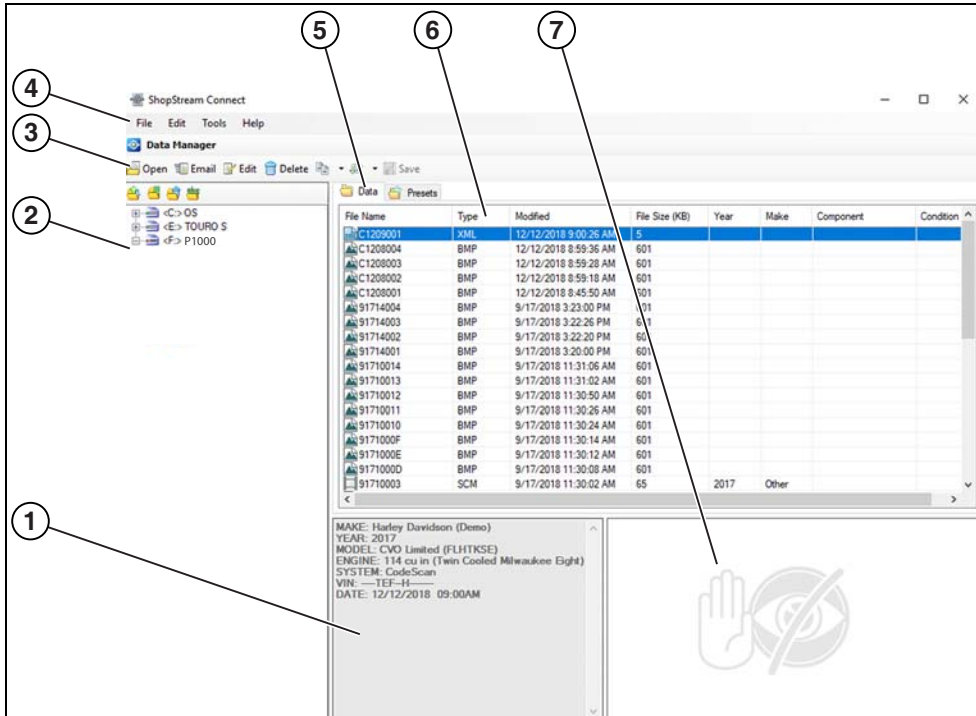

Figure 8-2

- 1— Notes Window**—allows you add notes to select data files. Select Save from the menu bar to save your notes. *NOTE: Not all file types allow notes, the Notes window will be grayed out when a file type that does not support notes is highlighted. Some image files may display notes for reference purposes (the notes are grayed out and not editable).*
- 2— File directory structure**—displays the file directory structure of your PC in standard Windows format, and shows any connected diagnostic tools at the bottom of the data list.
- 3— Data Manager Toolbar**—provides control icons that perform a variety of operations on data files.
- 4— Main Menu bar**—contains **File**, **Edit**, **Tools**, and **Help** menus.

- 5— Tabs**—provides access to data files and presets stored on the diagnostic tool or on the PC, and also allows viewing of software revision details of the diagnostic tool.
- 6— Main display**—shows stored data files details. *NOTE: The files listed are sortable (ascending/descending) by clicking on the column tab at the top (e.g. File Name, Type, etc.) Sort preferences are saved when the ShopStream Connect program is closed.*
- 7— Preview**—displays a sample of the file if the selected file is a image file.

8.3 Scanner DataViewer

SSC allows you to view data files recorded with your diagnostic tool, on your PC. When a Scanner data file is selected, it opens and displays in the Scanner DataViewer (*Figure 8-3*). Scanner DataViewer allows you play the data file and custom configure the data in a number of ways.



- 1— Menu bar
- 2— Display toolbar
- 3— Graph display
- 4— Properties icon
- 5— Vertical Scroll bar
- 6— Zoom controls
- 7— Slider bar
- 8— Navigation toolbar
- 9— Parameter text list
- 10—Highlighted PIDs - indicates graphs currently displayed
- 11—Parameter configuration tabs

Figure 8-3

8.4 Image Viewer

SSC allows you to view and print .bmp, .jpg and .sps image files (screenshots) saved on your diagnostic tool, with your PC.

NOTE

File extension types vary depending on the diagnostic tool. Not all the file extensions described here may be available on your diagnostic tool.

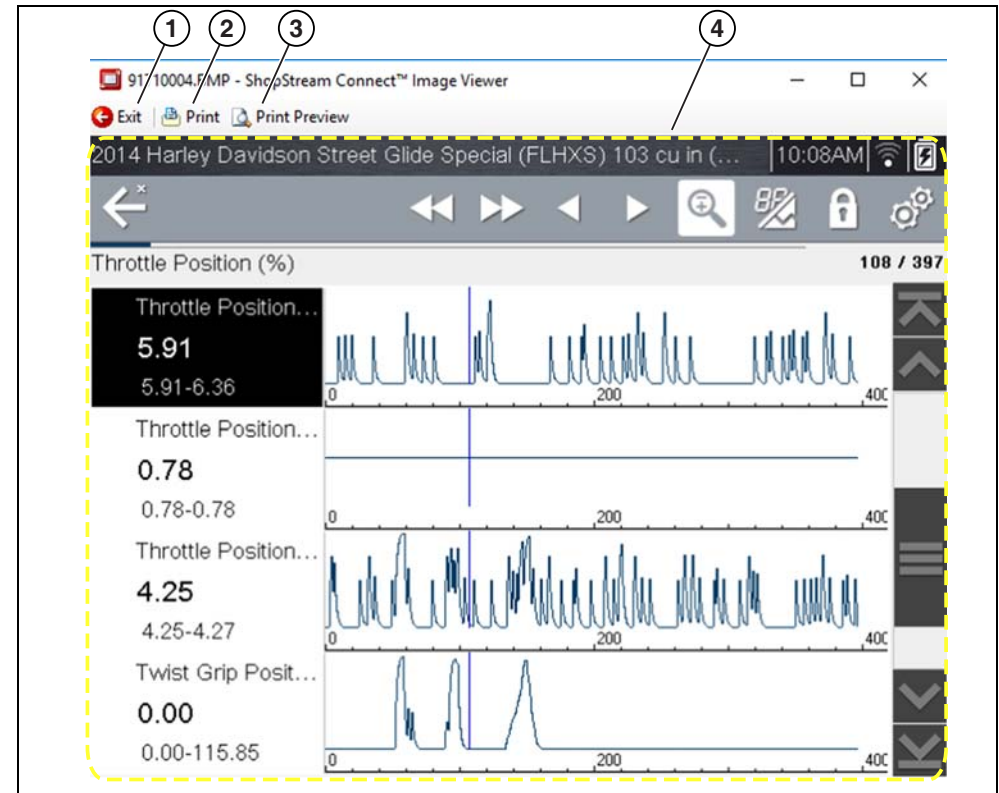

- 1— Exit - closes the Image Viewer
- 2— Print - prints the image
- 3— Print Preview - allows the image to be previewed before printing
- 4— Captured Screen Image

Figure 8-4

8.5 Printing the Code Scan Report

To print the Code Scan Report, the saved code scan .XML file must be opened using ShopStream Connect.

To print the Code Scan Report using ShopStream Connect:

1. Double-click the code scan .XML file from the file list to open the Code Scan Report (Figure 8-5) in the Code Scan Viewer (Figure 8-6).

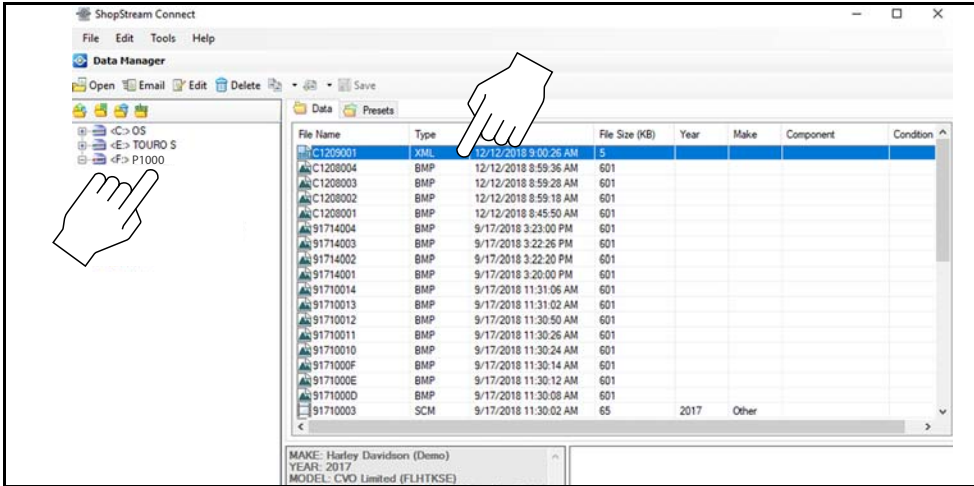

Figure 8-5

2. Select **Print** or **Print Preview** from the Code Scan Viewer menu to print or preview the report (Figure 8-6).

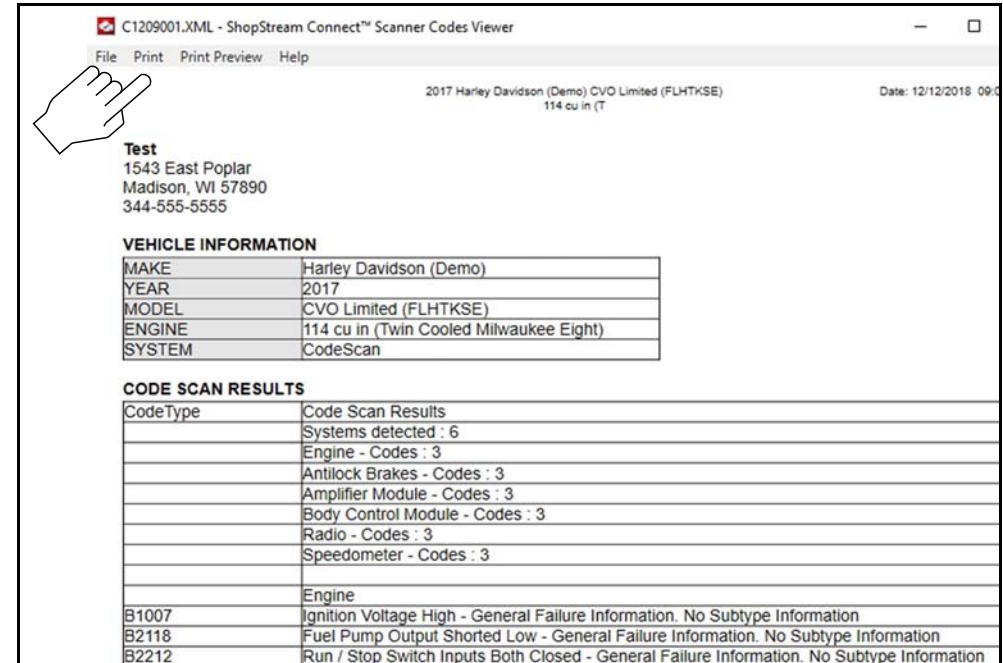

Figure 8-6

3. Selecting **Print** opens the Windows print dialog window (Figure 8-7). Select your printer from the list, then select **Print** to print the report.

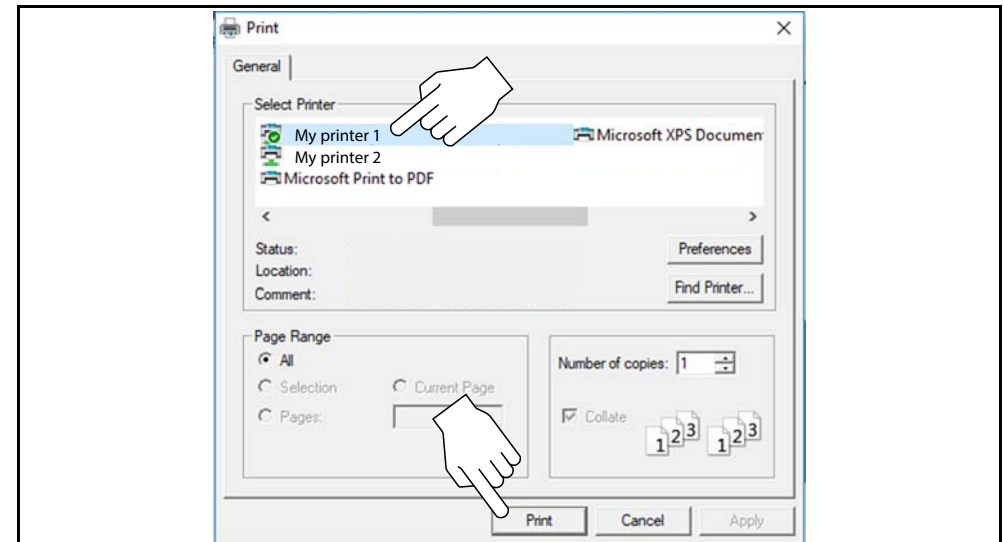

Figure 8-7



8.6 Customizing the Code Scan Report

Select fields of the Code Scan Report can be edited using ShopStream Connect.

To edit the Shop Information (header) of the Code Scan Report:

1. From ShopStream Connect, select **Tools > Options > Edit Shop Info** ([Figure 8-8](#)).

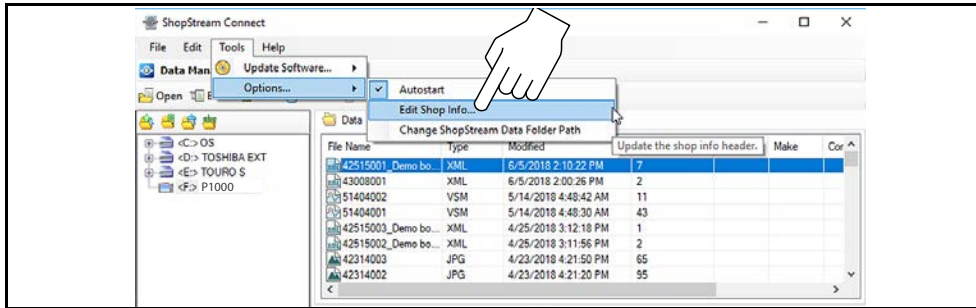

Figure 8-8

2. The **Shop Info** dialog box opens ([Figure 8-9](#)) allowing you to enter the name address, and phone number for your shop. This information is included as a header on the report.

Shop Name:

Zipcode:

Address 1:

Phone 1:

Address 2:

Phone 2:

City:

State/Province, County:

Messages

Line 1:

Line 2:

Line 3:

Use Shop Info in Printout Header

Use timestamp in Vehicle System Report

Print Header Preview

```
6/6/2018 2:57 PM
SampleShop
1543 East Poplar
Madison WI 57890
344-555-5555
```

Figure 8-9

A preview panel at the bottom of the box shows how the information will appear on a print out ([Figure 8-9](#)).

3. Check the **“Use Shop Info in Printout Header”** box to show the Shop Info in the printout ([Figure 8-9](#)).
4. Check the **“Use timestamp in Vehicle System Report”** box to show the time the vehicle was scanned in the printout ([Figure 8-9](#)).
5. When you are finished editing, select **Save** ([Figure 8-9](#)) to save the information and close the dialog box.



8.7 Software Upgrades and Updates

Upgrade/Update Descriptions:

- **Software Upgrade** - a software upgrade is a new software version (contact your sales representative for purchase information).
- **Software Update** - a software update is a service release for installed software. These are available free of charge, and are provided as necessary to update installed software. When your diagnostic tool is connected to a PC using SSC, the SSC software will automatically check for updates, and if an update is available, it will provide installation instructions. Follow the screen prompts to accept, download and install the software.

i NOTE

To receive updates or upgrades, SSC software must be installed on your PC and have connection to the Internet.



Example - Updating diagnostic tool software:

1. Select **Tools > Update Software > (diagnostic tool type - e.g. P1000)** from the Menu bar ([Figure 8-10](#)).

The software checks the Snap-on web server for available updates.

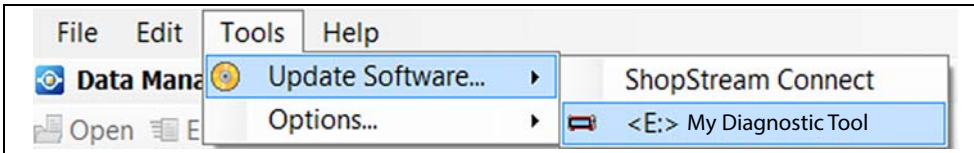

Figure 8-10

2. If service release updates are available, select **Next** to continue, then select **Download** and follow the on-screen instructions to complete the installation ([Figure 8-11](#)).

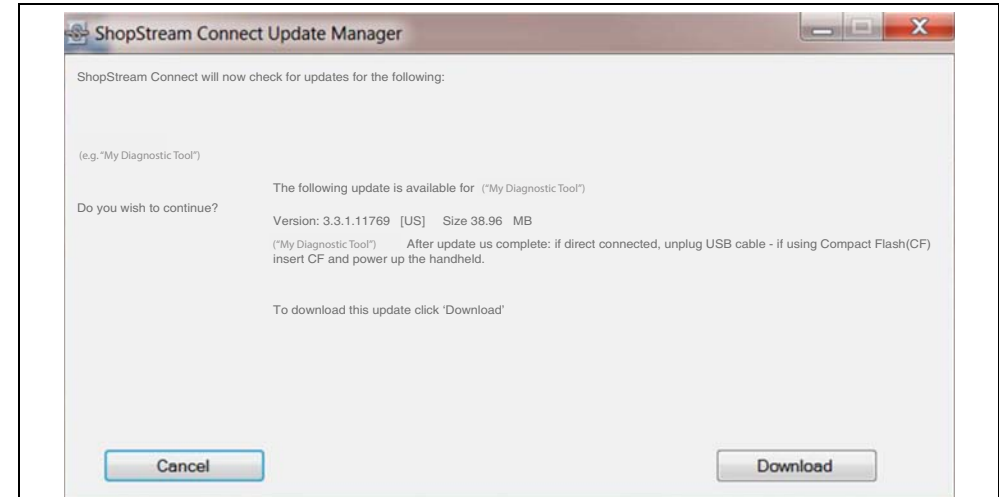

Figure 8-11

i NOTE

For additional information on ShopStream Connect software updates and upgrades, download the ShopStream Connect User Manual from our website: <http://diagnostics.snapon.com/usermanuals>



8.7.1 End User License Agreement

Before software installation at initial purchase, and before all subsequent software updates/upgrades installations End User License Agreement (EULA) acceptance is required.

IMPORTANT

Use of Software is governed by the terms and conditions of the End User License Agreement. The diagnostic tool should not be initially operated until the End User License Agreement is read. Use of the device acknowledges your acceptance of the End User License Agreement. The Snap-on Incorporated Software End User License Agreement is available at: <https://eula.snapon.com/diagnostics>

To Accept: at the screen prompt (*Figure 8-12*) click the checkbox on the left side of the window, and then select **Agree and Continue**. The software will be installed automatically.

Figure 8-12 below represents a typical EULA acceptance agreement screen.

THIS IS A LEGALLY BINDING AGREEMENT WITH SNAP-ON INCORPORATED AND YOU CONFIRM THAT YOU HAVE THE AUTHORITY TO ENTER INTO THIS AGREEMENT ON BEHALF OF YOURSELF AND/OR ON BEHALF OF THE PERSON OR ENTITY WHO ACQUIRED THE SOFTWARE. BY CHECKING THE BOX AND CLICKING "AGREE AND CONTINUE," YOU UNDERSTAND AND AGREE TO THE TERMS AND CONDITIONS FOUND AT: <https://eula.snapon.com/diagnostics>, AND THAT YOU HAVE ACCESSED AND READ SUCH TERMS. IF YOU DO NOT OR CANNOT AGREE TO THESE TERMS, YOU MUST CLICK "I DECLINE."

I Decline **Agree and Continue**

Figure 8-12 Typical EULA acceptance screen

To Decline: at the screen prompt (*Figure 8-12*) select **I Decline**. A confirmation message is displayed providing options to Go Back or Exit the software installation (*Figure 8-13*).

By declining the license agreement, you will exit the upgrade process.

Are you sure that you want to exit?

Go Back **Exit**

Figure 8-13 Typical EULA acceptance screen



This section describes basic cleaning and battery replacement procedures for your diagnostic tool.

Main Topic Links

- [Cleaning and Inspecting the Diagnostic Tool](#) page 57
- [Battery Pack Service](#) page 57
- [Cleaning the Touch Screen](#) page 57
- [Safety](#) page 57
- [Ordering a New Battery Pack](#) page 58
- [Removing / Installing the Battery Pack](#) page 58
- [Disposing of the Battery Pack](#) page 59

9.1 Cleaning and Inspecting the Diagnostic Tool

Periodically perform the following tasks to keep your diagnostic tool in proper working order:

- Check the housing, cables and connectors for dirt and damage before and after each use.
- At the end of each work day, wipe the diagnostic tool housing, cables and connectors clean with a damp cloth.

IMPORTANT

Do not use any abrasive cleansers or automotive chemicals on the diagnostic tool.

9.1.1 Cleaning the Touch Screen

The touch screen can be cleaned with a soft cloth and a mild window cleaner.

IMPORTANT

Do not use any abrasive cleansers or automotive chemicals on the touch screen.

9.2 Battery Pack Service

9.2.1 Safety

Follow all safety guidelines when handling the battery pack.



! WARNING

Risk of electric shock.

- **Prior to recycling the battery pack, protect exposed terminals with heavy insulating tape to prevent shorting.**
- **Disconnect all test leads and turn diagnostic tools off before removing the battery pack.**
- **Do not attempt to disassemble the battery or remove any component projecting from or protecting the battery terminals.**
- **Do not expose the diagnostic tool or battery pack to rain, snow, or wet conditions.**
- **Do not short circuit the battery terminals.**

Electric shock can cause injury.

WARNING

Risk of explosion.

- **The Lithium battery is factory replaceable only, incorrect replacement or tampering with the battery pack may cause an explosion.**

Explosion can cause death or serious injury.

IMPORTANT

The battery pack contains no user serviceable components. Tampering with the battery pack terminals or housing will void the product warranty.

Keep the following in mind when using and handling the battery pack:

- Do not short circuit battery pack terminals.
- Do not immerse the diagnostic tool or battery pack in water, or allow water to enter the diagnostic tool or battery pack.
- Do not crush, disassemble, or tamper with the battery pack.
- Do not heat the battery pack to over 100°C (212°F), or dispose of it in a fire.
- Do not expose the battery pack to excessive physical shock or vibration.
- Keep the battery pack out of reach of children.
- Do not use a battery pack that appears to have suffered abuse or damage.
- Charge the battery pack in the appropriate charger only.
- Do not use a battery charger that has been modified or damaged.
- Use the battery pack for the specified product only.
- Store the battery pack in a cool, dry, well ventilated area.

NOTE

The battery pack should be used within a short period of time (about 30 days) after charging to prevent loss of capacity due to self-discharging.

If long-term storage of the battery pack is necessary, it should be stored in a cool, dry, well ventilated place with a 30 to 75 percent state of charge to prevent loss of characteristics.

To prolong the life of your battery, turn off the diagnostic tool when not in use. The diagnostic tool has a built in charger that recharges the battery on demand whenever it is connected to a power source.

9.2.2 Ordering a New Battery Pack

If the battery pack needs to be replaced, contact your sales representative to order a new battery pack.

IMPORTANT

Only use the recommended Snap-on replacement battery pack.

9.2.3 Removing / Installing the Battery Pack

IMPORTANT

If replacing the battery pack, only use the recommended Snap-on replacement battery pack.

To remove the battery pack:

1. Loosen the battery cover screw, until the battery cover is loose from the housing (*Figure 9-1*).
2. Remove the battery pack cover.
3. Pull the bottom edge of the battery pack up then tilt it out to remove.

To install the battery pack:

1. Position the battery pack with the arrows (on the battery pack) facing up (*Figure 9-1*).
2. Tilt the top of the battery pack in to align the tabs, then down to install into place.
3. Install the battery pack cover, in the opposite manner as removal, aligning the tabs and tilting down and in into place.
4. Tighten the battery pack cover screw.

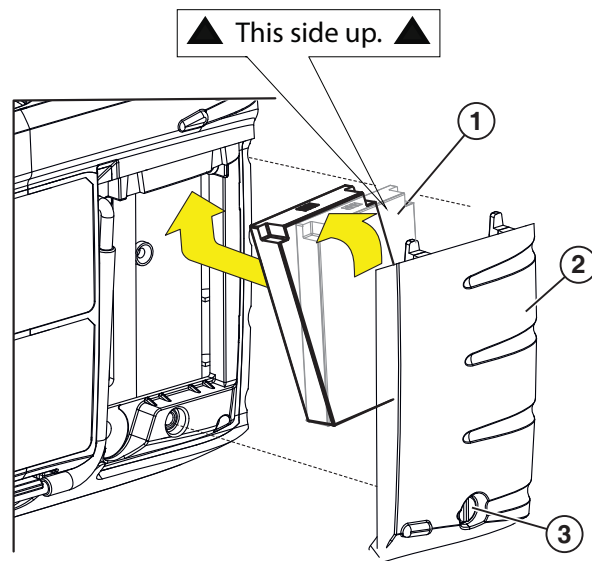

- 1— Battery Pack
- 2— Battery Pack Cover
- 3— Battery Pack Cover Screw

Figure 9-1

9.2.4 Disposing of the Battery Pack

Always dispose of the battery pack according to local regulations, which vary for different countries and regions. The battery pack, while non-hazardous waste, does contain recyclable materials. If shipping is required, ship the battery pack to a recycling facility in accordance with local, national, and international regulations.

IMPORTANT

Always dispose of materials according to local regulations.

For additional information within the **United States of America** contact:

- Rechargeable Battery Recycling Corporation (RBRC) at www.call2recycle.org
Phone - 800 822-8837

For additional information within **Canada** contact:

- Rechargeable Battery Recycling Corporation (RBRC) at www.call2recycle.ca
Phone - 888 224 9764

Products bearing the WEEE logo ([Figure 9-2](#)) are subject to European Union regulations.



Figure 9-2 WEEE logo

Contact your sales representative for details.



Legal Information

Trademarks

Snap-on is a trademark registered in the United States and other countries of Snap-on Incorporated. All other marks are trademarks or registered trademarks of their respective holders.

Copyright Information

© 2019 Snap-on Incorporated. All rights reserved.

Software License Information

Use of Software is governed by the terms and conditions of the End User License Agreement. The End User License Agreement is provided with the diagnostic tool and the device should not be initially operated until the End User License Agreement is read. Use of the device acknowledges your acceptance of the End User License Agreement. The Snap-on Incorporated Software License Agreement is available at: <https://eula.snapon.com/diagnostics>

Patent Information

For a listing of Snap-on products that are protected by patents in the United States and elsewhere, visit: <https://patents.snapon.com>

Manual Application

This manual includes information and images applicable to the diagnostic software version that was current at the time of publication. Some information within this manual may not be applicable to later diagnostic software versions.

Disclaimer of Warranties and Limitation of Liabilities

All pictures and illustrations shown are for reference purposes only. All information, specifications and illustrations in this manual are based on the latest information available at the time of printing and are subject to change without notice. While the authors have taken due care in the preparation of this manual, nothing contained herein:

- Modifies or alters in any way the standard terms and conditions of the purchase, lease, or rental agreement under the terms of which the equipment to which this manual relates was acquired.
- Increases in any way the liability to the customer or to third parties.

Snap-on® reserves the right to make changes at any time without notice.

IMPORTANT

Before operating or maintaining this unit, please read this manual carefully paying extra attention to the safety warnings and precautions.

Manuals / Technical Documentation - The information in this manual is periodically revised to ensure the latest information is included. Download the latest version of this manual and other related technical documentation from the Snap-on Diagnostics website.



FCC Compliance Statement

This equipment has been tested and found to comply with the limits for a Class B digital device, pursuant to part 15 of the FCC rules. These limits are designed to provide reasonable protection against harmful interference in a residential installation. This equipment generates, uses and can radiate radio frequency energy and, if not installed and used in accordance with the instructions, may cause harmful interference to radio communications. However, there is no guarantee that interference will not occur in a particular installation. If this equipment does cause harmful interference to radio or television reception, which can be determined by turning the equipment off and on, the user is encouraged to try to correct the interference by one or more of the following measures:

- Reorient or relocate the receiving antenna.
- Increase the separation between the equipment and receiver.
- Connect the equipment into an outlet on a circuit different from that to which the receiver is connected.
- Consult the dealer or an experienced radio/TV technician for help.

CAUTION

You are cautioned that changes or modifications not expressly approved by the party responsible for compliance could void your authority to operate the equipment.

FCC RF Radiation Exposure Statement

1. This transmitter must not be co-located or operating in conjunction with any other antenna or transmitter.
2. This equipment complies with FCC RF radiation exposure limits set forth for an uncontrolled environment. This device was tested for typical lap held operations with the device contacted directly to the human body to the back side of the Display Unit. To maintain compliance with FCC RF exposure compliance requirements, avoid direct contact to the transmitting antenna during transmitting.
3. According to FCC 15.407(e), the device is intended to operate in the frequency band of 5.15GHz to 5.25GHz under all conditions of normal operation. Normal operation of this device is restricted to indoor use only to reduce any potential for harmful interference to co-channel MSS operations.